

IHE 2020

Density dependent groundwater flow in the coastal zone

Gualbert Oude Essink, PhD

Lecture set-up: 4*(45min, 15min break)

- PowerPoint sheets
- Lecture Notes
- Practicals numerical modelling

<http://freshsalt.deltares.nl>

Deltares
Unit Subsurface and Groundwater Systems
gualbert.oudeessink@deltares.nl



17-18-22-24 June 2020

Introduction

Curriculum Vitae

- Delft University of Technology, Civil Engineering: till 1997
Ph.D.-thesis: Impact of sea level rise on groundwater flow regimes
- Utrecht University, Earth Sciences: till 2002
- Free University of Amsterdam, Earth Sciences: till 2004
- Deltares
- Utrecht University (Associate Professor): from 2014

Qualifications:

- Groundwater resources management
- Density-dependent groundwater flow and coupled solute transport
- Salt water intrusion in coastal aquifers
- Assessment of climate change on groundwater resources
- Numerical Modeling
- Teaching and training

<http://freshsalt.deltares.nl>

Deltares: gualbert.oudeessink@deltares.nl

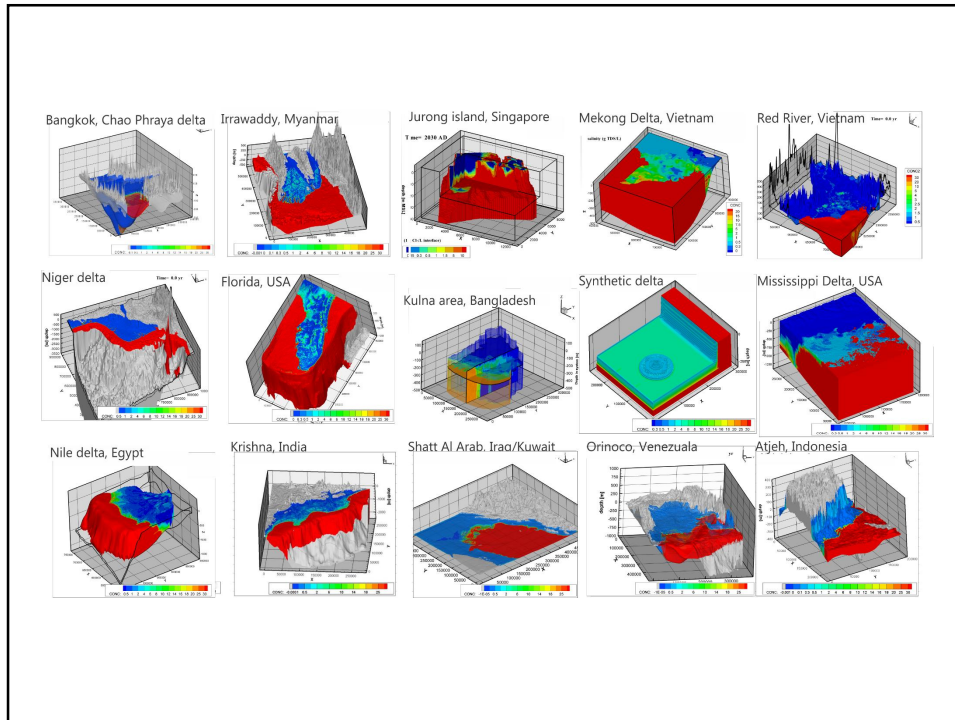

Research on groundwater in the coastal zone

- 20 years experience in modelling variable-density dependent groundwater flow and coupled solute transport in the coastal zone
- Incorporating monitoring campaigns results in numerical modeling tools
- Research on new fresh-saline phenomena: salty seepage boils and shallow freshwater lenses in saline environments
- Knowledge on creating 3D initial chloride distribution, based on geostatistics and geophysical data (analyses, VES, borehole measures, AEM)
- Quantifying effects of climate change and sea level rise on fresh groundwater resources
- Developing adaptive and mitigative measures to stop salinization in the coastal groundwater system (e.g. ASR, MAR: fresh keeper, coastal collectors, freshwater storage underground)

Lecture notes, practicals and ppt on freshsalt.deltares.nl

1. Density dependent groundwater flow

<http://publicwiki.deltares.nl/download/attachments/22183944/gwm2.pdf?version=1&modificationDate=1268945548000>

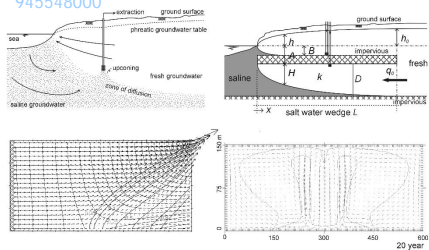

2. Groundwater modelling

<http://publicwiki.deltares.nl/download/attachments/22183944/gwm1.pdf?version=1&modificationDate=1268750652000>

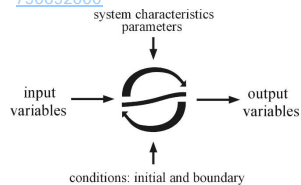

<http://publicwiki.deltares.nl/display/FRESHSALT/Upload>

Introduction

Practicals numerical modelling

- PMWIN
- SEAWAT
- Cases:
 - Rotating sharp interface
 - Freshwater lens
 - Henry's case
 - (Elder's case)
- Setup practicals:
 - try to work together in teams, e.g. of two persons
 - short report of findings (make screenshots)
 - deliver within two weeks after finish last SWI lectures

<http://freshsalt.deltares.nl>

Deltares: gualbert.oudeessink@deltares.nl

Practicals

- Rotating sharp interface

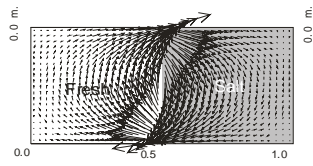

- Freshwater lens

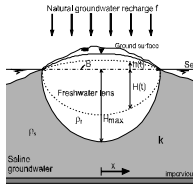

- Henry's case

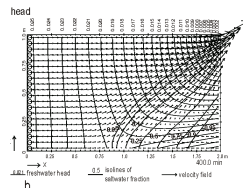

- (Elder's case)

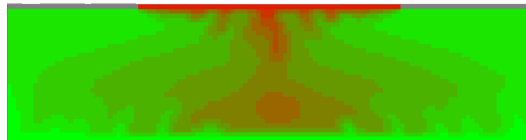

Volumes of water on Earth: a scarce product

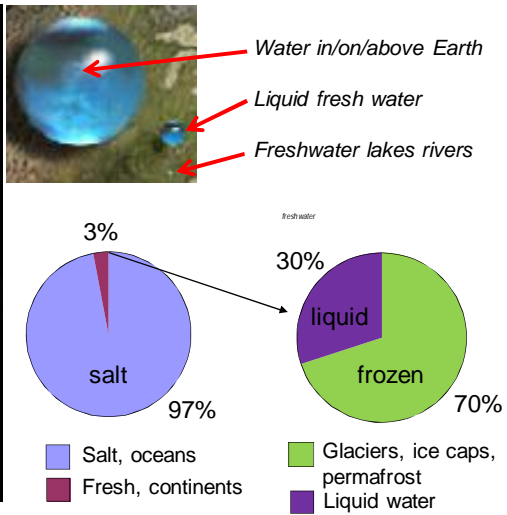
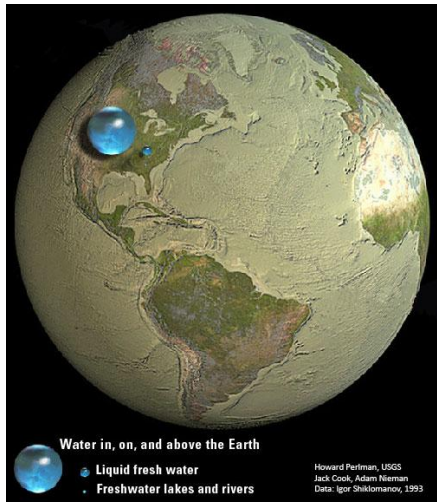

Source: Perlman, USGS; Shiklomanov, 1993

Water Energy Food Nexus Global water scarcity

Fresh water is a scarce resource...

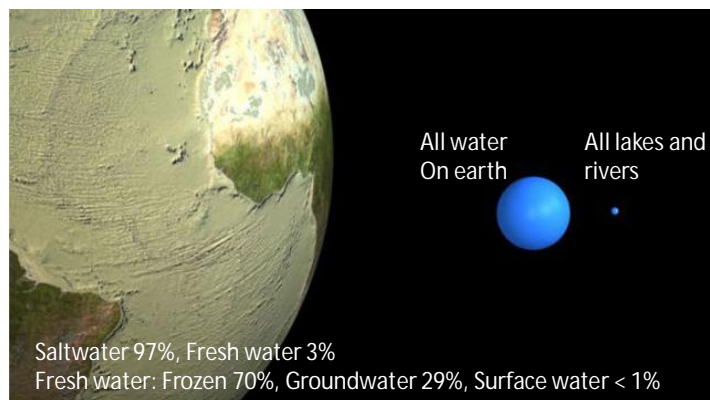

Water on Earth

Total water on Earth

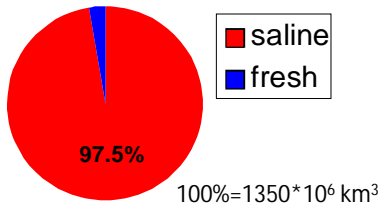

Total fresh water on Earth

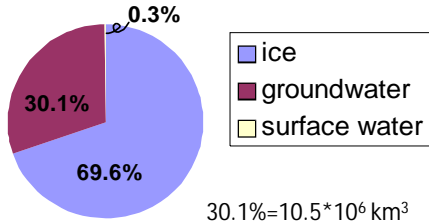

Demand for groundwater (now 30%) increases due to:

- increase world population & economical growth
- loss of surface water due to contamination
- great resource: available in large quantities
- still unpolluted (relative to surface water)

(Source: Cheng, 1998)

Groundwater in the coastal zone

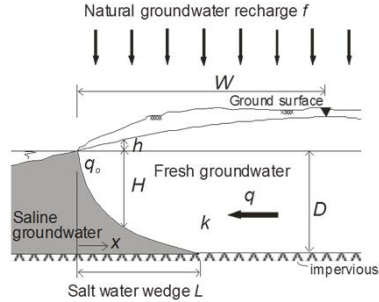
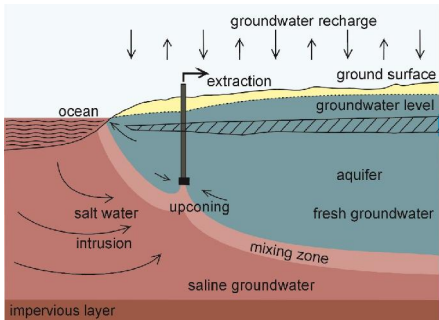

500 million people in the first 5km from the coastline

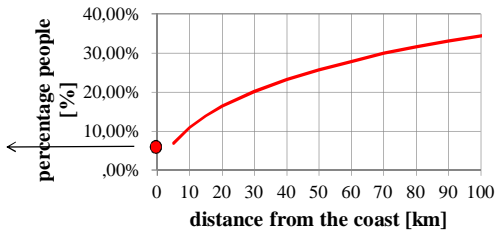

Topics of density driven groundwater flow

1. Introduction
 - water on earth
 - salt water intrusion
 - freshwater head
2. Interface between fresh and saline groundwater
 - analytical formulae (Badon Ghyben-Herzberg)
 - upconing example
3. Numerical modelling
 - mathematical background
 - Benchmark problems: Henry, Elder, Hydrocoin, etc.
4. Case-studies
 - hypothetical cases
 - 2D, 3D cases
 - real cases (Dutch coastal zone)

Work at Deltares

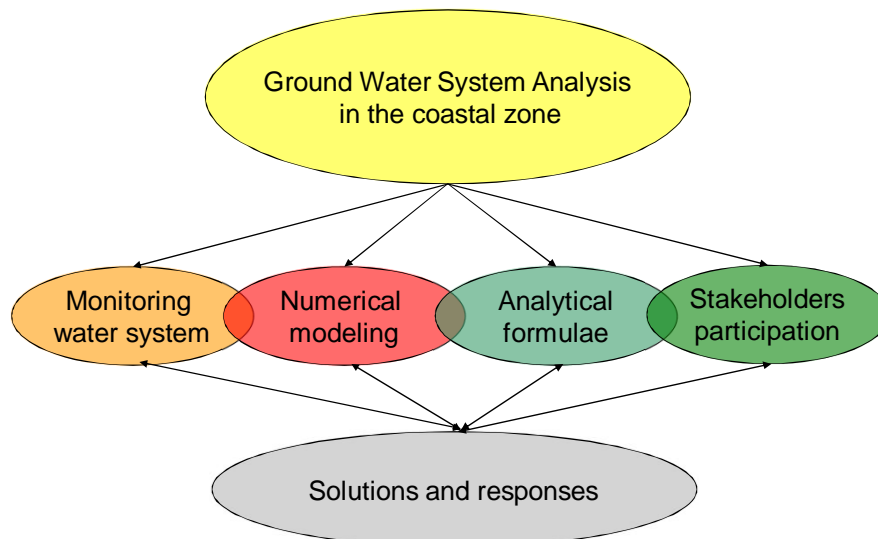

Groundwater issues in the coastal zone/deltaic areas

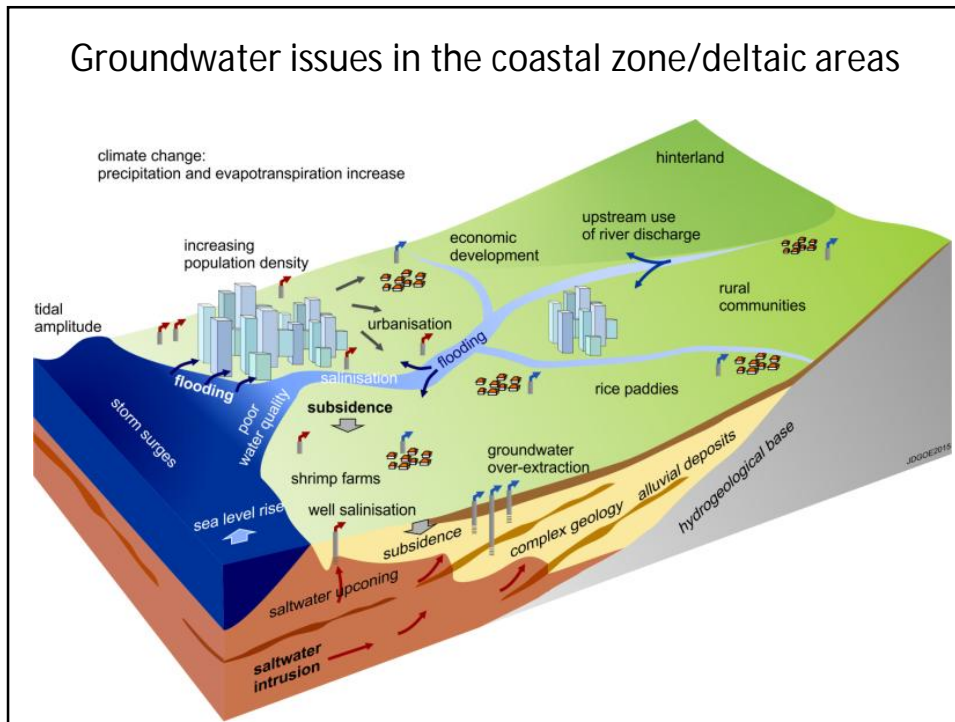

Past, before man

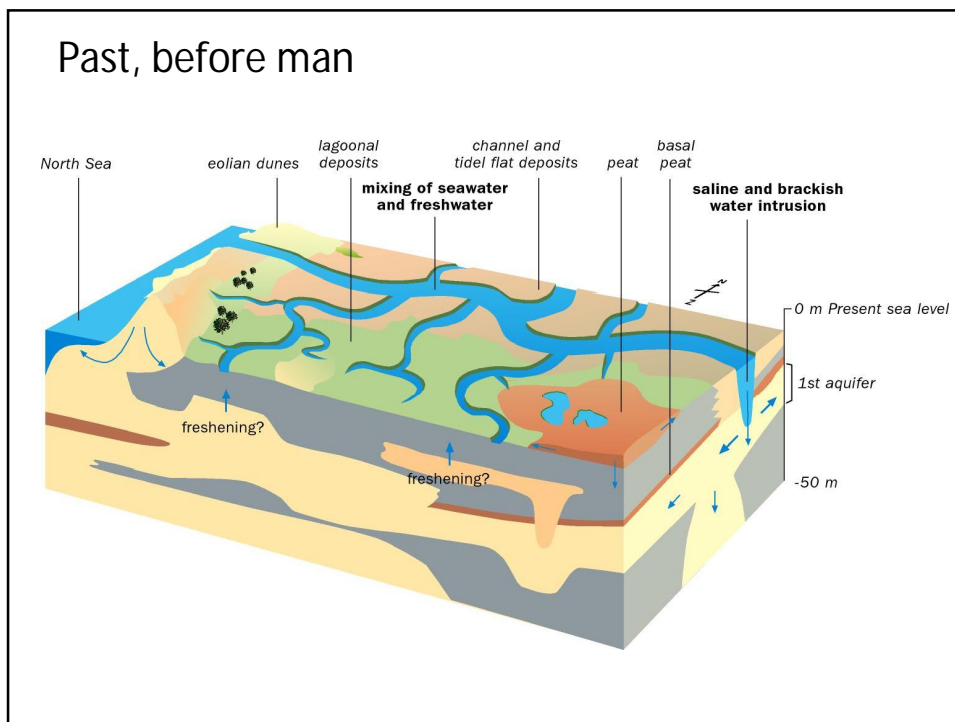

The polders in the Nederland

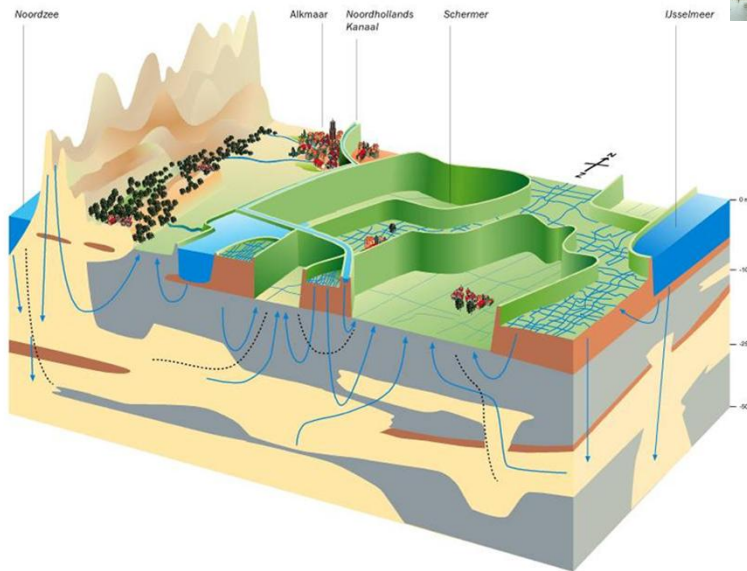

Groundwater in the future

We have to cope which...:

- We have to cope which...:
- Groundwater extractions
- Development energy use/production (heat-cold)
- Climate change
- Land subsidence
- Development spatial land use
- **Politics, Policy & Watermanagement**

Direct anthropogenic influence on groundwater is more important than climate effect

Salt Water Intrusion Meeting, since 1968

Salt Water Intrusion Meeting, since 1968



<http://www.swim-site.org/>

Themes

- Water system analysis
- Monitoring
- Modelling
- Effects
- Solutions



Salt Water Intrusion Meeting (SWIM)

[Home](#) [History](#) [Philosophy](#) [Next meeting](#) [Proceedings](#) [Links](#)

Welcome to the homepage of the Salt Water Intrusion Meeting

The Salt Water Intrusion Meeting (SWIM) conference series has been held in different countries on a biennial basis since 1968. Although the main focus has traditionally been on seawater intrusion, contributions related to saline groundwater more broadly are also considered. The meetings are attended by a multidisciplinary group of people with a wide variety of expertise, including chemistry, engineering, geology, geophysics, mathematics, physics, and management.



[SWIM from Alphafilm & Kommunikation on Vimeo.](#)

The long-lived success of the conference series reflects the relevance of managing saline groundwater problems around the world, especially in densely populated coastal areas. These include:

- increased demand due to economic development and population growth
- over-exploitation of water resources, especially in arid and semi-arid areas
- contamination and quality deterioration of water resources
- characterization of groundwater systems and movement of saline groundwater
- management and prevention of salinization
- natural and man-made environmental change

www.swim-site.org

The main aims of this web site are to be the central and permanent source of information for people interested in the SWIM and to increase awareness and provide access of the excellent work that is presented at the SWIM meetings

Salt Water Intrusion Meeting (SWIM)

[Home](#) [History](#) [Philosophy](#) [Next meeting](#) [Proceedings](#) [Links](#)

The proceedings of the Salt Water Intrusion Meeting

The SWIM proceedings span a period of almost 40 years. The proceedings of the first informal meeting consisted of a few pages in German. Successive meetings all had regular proceedings. They provide an excellent overview of the developments in the research of saline groundwater over the past decades.

At the 18th SWIM in Cartagena it was agreed that efforts will be undertaken to make all SWIM proceedings available through the internet. Currently, the proceedings of the 9th, 12th, 13th, 15th, 16th, 17th, 18th, 19th, 20th, and 21st SWIM and the abstracts of the 18th SWIM are available from this web site. The proceedings of other meetings will become available as soon as they have been digitized. Some hardcopies of proceedings can still be ordered from various publishers. Links to these are provided on this page.

Available for download:

- [24th SWIM, Cairns, Australia, 2016](#)
- [23rd SWIM, Husum, Germany, 2014](#)
- [22nd SWIM, Buzios, Brazil, 2012](#)
- [21st SWIM, S. Miguel, Azores, Portugal, 2010](#)
- [20th SWIM, Naples, Florida, USA, 2008 \(abstracts\)](#)
- [19th SWIM, Cagliari, Italy, 2006](#)
- [18th SWIM, Cartagena, Spain, 2004](#)
- [18th SWIM, Cartagena, Spain, 2004 \(abstracts\)](#)
- [17th SWIM, Delft, The Netherlands, 2002](#)
- [16th SWIM, Wolin Island, Poland, 2000](#)
- [15th SWIM, Ghent, Belgium, 1998](#)
- [14th SWIM, Malmö, Sweden, 1996](#)
- [13th SWIM, Cagliari, Italy, 1994](#)
- [12th SWIM, Barcelona, Spain, 1992](#)
- [11th SWIM, Danzig, Poland, 1990](#)
- [10th SWIM, Ghent, Belgium, 1988](#)
- [9th SWIM, Delft, The Netherlands, 1986](#)
- [8th SWIM, Bari, Italy, 1983](#)
- [7th SWIM, Uppsala, Sweden, 1981](#)
- [6th SWIM, Hannover, Germany, 1979](#)
- [5th SWIM, Medmenham, United Kingdom, 1977](#)
- [4th SWIM, Ghent, Belgium, 1974](#)
- [3rd SWIM, Copenhagen, Denmark, 1972](#)
- [2nd SWIM, Vogelzang, The Netherlands, 1970](#)
- [1st SWIM, Hannover, Germany, 1968](#)

www.swim-site.org

For sale (external links)

- [Proceedings of the 12th Salt Water Intrusion Meeting, Barcelona, Spain, 1992](#)
- [Proceedings of the 6th Salt Water Intrusion Meeting, Hannover, Germany, 1979](#)

Salt Water Intrusion Meeting (SWIM)

Home History Next meeting **Proceedings** Links About this site

[Back to all proceedings](#)

Proceedings of the 24th Salt Water Intrusion Meeting, Cairns, Australia, 2016

Preface
[A.D. Werner](#)

Posters

[S. Fatema, A. Marandi, C. Schijth](#) Seawater Intrusion of the Coastal Groundwater: A Case Study in Cox's Bazar, Bangladesh
[A. Kawachi, C. Uchida, M. Kefi, J. Tarhouni, K. Kashiwagi](#) Effect of Surface Water Use on Mitigation of GW Salinization in a Semi-Arid Coastal Shallow Aquifer Setting: A Case Study of Lower Lebrna Watershed, Tunisia
[D. Vandeveldt](#) Increasing the Availability of Freshwater for Agriculture by Improving Local Hydro(geo)logical Conditions
[Finaim, A. E., Luc Lebbe, F. Sadooni, Hamad Al Saad](#) Potential Influence of Climate Change and Anthropogenic Effects, on Groundwater Resources in the Northern Groundwater Province, Qatar
[J. van Engelen, G.H.P. Oude Essink, M.F.P. Bierkens](#) Fresh Groundwater Reserves in 40 Major Deltas Under Global Change
[Bernard Sijmon, Esther van Baaren, Willem Cabelaussen, Joost Delsman, Jan Gunnink, Marius Karagous, Ferry G.B. de Louw, G.H.P. Oude Essink, Pieter Pauw, Annika Steuer](#) HEM Survey in Zeeland (NL) to Delineate the 3D Groundwater Salinity Distribution - Pilot Study: Canal Zone Gent-Terneuzen
[Kees-Jan van der Made, Frans Schaars, Michel Groen](#) Geophysical Field Measurements for Characterizing Sea Water Intrusion
[Kouping Chen, Jiu Jimmy Jiao](#) Hydrochemical Evolution of Groundwater in a Coastal Reclaimed Land in Shenzhen, China
[Georg J. Houben, Willem Jan Zaadnoordijk, Klaus Hinsby, Lars Troidborg](#) Water Supply on the Frisian Islands, North Sea
[Victoria Trojawnik, C. Robinson, Dean Morrow, Darren White, Viviane Paquin, Keia Weber](#) Effect of Tides, Waves and Precipitation on Groundwater Flow Dynamics on Sable Island, Canada
[Ferry G.B. de Louw, Guis Hesselmans, Vincent Klap, Corstiaan Kempenaar, Edvard Ahlrichs, Jean-Pierre van Wesemael, Joost Delsman](#) In Search for a Salt Tolerant Potato to Reduce the Freshwater Demand in Saline Coastal Areas
[Yoncheol Kim, Heesung Yoon, Gi-Pyo Kim](#) Case Study on an Effective Method for Monitoring Temporal Change in the Freshwater-Saltwater Interface Location and Freshwater Lens Thickness
[Jason A. Thomann, Leanne K. Morgan, Tony Miller, Adrian D. Werner](#) Vulnerability of Offshore Fresh Groundwater to Anthropogenic Impacts: Investigation Using Analytic and Numerical Modelling Techniques
[A. Saha, W.K. Lee, A. Bironne-Taine, V. Babovic, L. Vonhögen-Peeters, Esther van Baaren, P. Vermeulen, G.H.P. Oude Essink, J.R. Valstar, G. de Lange, R.M. Hoogendoorn, S. Con](#) Utilization of Reclaimed Island as Groundwater Reservoir
[M.L. Calvache, J.P. Sánchez-Ubeda, Carlos Dupoué, M. López-Chicano](#) The Influence of the Heterogeneity and Variable Density in Theis and Cooper-Jacob Interpretation of Pumping Tests: The Case of Motri-Salobreña Aquifer (SE Spain)
[J.P. Sánchez-Ubeda, M.L. Calvache, Carlos Dupoué, M. López-Chicano](#) Modelling Sea-Aquifer Contact in Salt Water Intrusion Scenarios: Conditions and Possibilities
[Eiad Levannon, Eyal Shalev, Yoseph Yecheli, Haim Gvirtzman](#) Estimation of Hydraulic Diffusivity Using Tidal-Extracted Oscillations from Groundwater Head Affected by Tide
[Eiad Levannon, Eyal Shalev, Yoseph Yecheli, Haim Gvirtzman](#) The Mechanism of Groundwater Fluctuations Induced by Sea Tides in Unconfined Aquifers
[Gang Li, Hailong Li, Chunmiao Zheng, Kai Xiao, Manhua Luo, Jiemo Zhang](#) A Comparative Study of Two Transects at Gan'ao River's Estuary in Daya Bay, China
[Xuejing Wang, Hailong Li, Chunmiao Zheng](#) Seasonal Distribution of Radium Isotopes and Submarine Groundwater Discharge in Lashou Bay, China
[Kai Xiao, Hailong Li, Chunmiao Zheng, Yanman Li, Manhua Luo](#) A Preliminary Study on Influence of Seawater-Groundwater Exchange on Nutrient Dynamics in a Tidal Mangrove Swamp in Daya Bay, China
[Ashraf Ahmed, Robert Gantley, Antofli Abdouhalik](#) The Effect of Cutoff Walls on Saltwater Intrusion in Stratified Coastal Aquifers: An Experimental and Numerical Study
[Andrew C. Kijpshof, Leanne K. Morgan, Adrian D. Werner](#) Offshore Hydro-Stratigraphy of the Gambier Embayment and the Potential for an Offshore Groundwater Resource
[I. Oz, Eyal Shalev, Yoseph Yecheli, Haim Gvirtzman](#) Saltwater Circulation Patterns Within the Freshwater-Saltwater Interface in Coastal Aquifers
[Sang Kil Park, Do Hoon Kim, Hong Bum Park](#) The Investigation of Sea Water Intrusion on Opening Estuary Barrage of Nakdong River Using Numerical Simulation Model
[Chenqil Shen, Pei Xin, Chenming Zhang, Ling Li](#) Initiation of Unstable Flow in Salt Marshes

Session 1 - Managing Coastal Groundwater I

[G.H.P. Oude Essink](#) Fresh Groundwater Resources in Deltaic Areas Under Climate and Global Stresses, with Examples from Vietnam, Egypt, Bangladesh and The Netherlands

www.swim-site.org

Location of SWIM studies since 1968

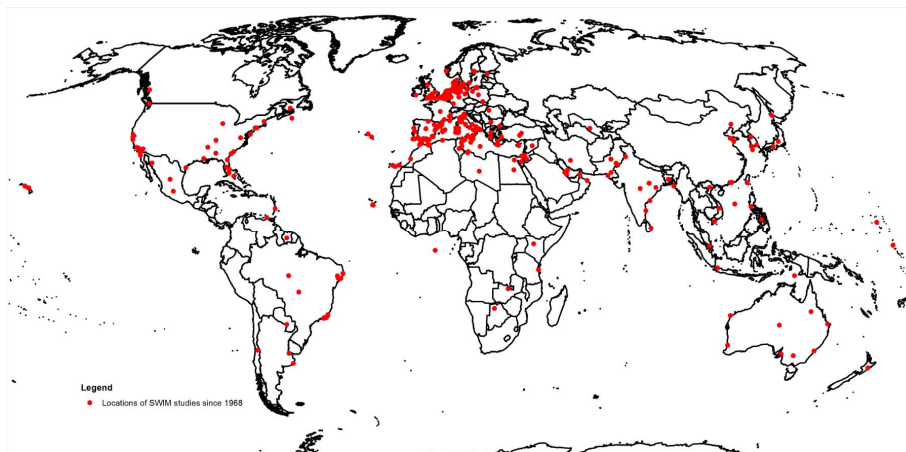

Location of SWIM studies since 1968

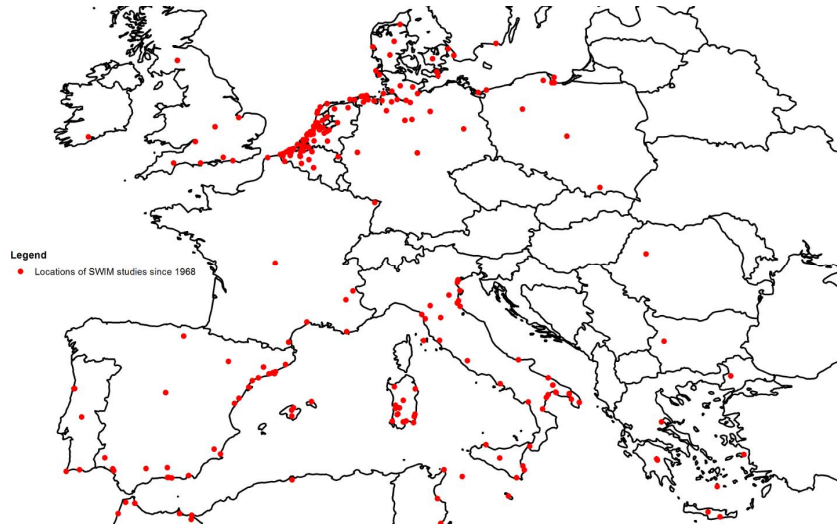

Introduction SWI

Definition of salt water intrusion

Inflow of saline water into an aquifer which contains fresh water

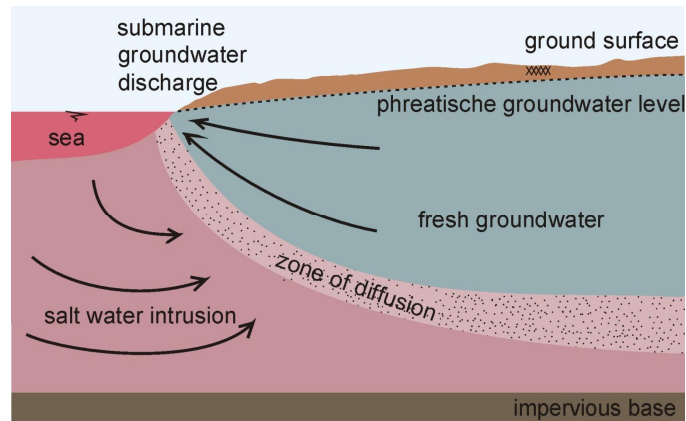

Origin of saline groundwater in the subsoil

Geological causes:

- marine deposits during geological times
- trans- and regressions in coastal areas (deltas)
- salt/brine dome

Anthropogenic causes:

- agriculture/irrigation (salt damage Middle East & Australia)
- upconing under extraction wells throughout the world
- upconing under low-lying areas (e.g. Dutch polders)

Modes of Salinization due to Sea-Level Rise

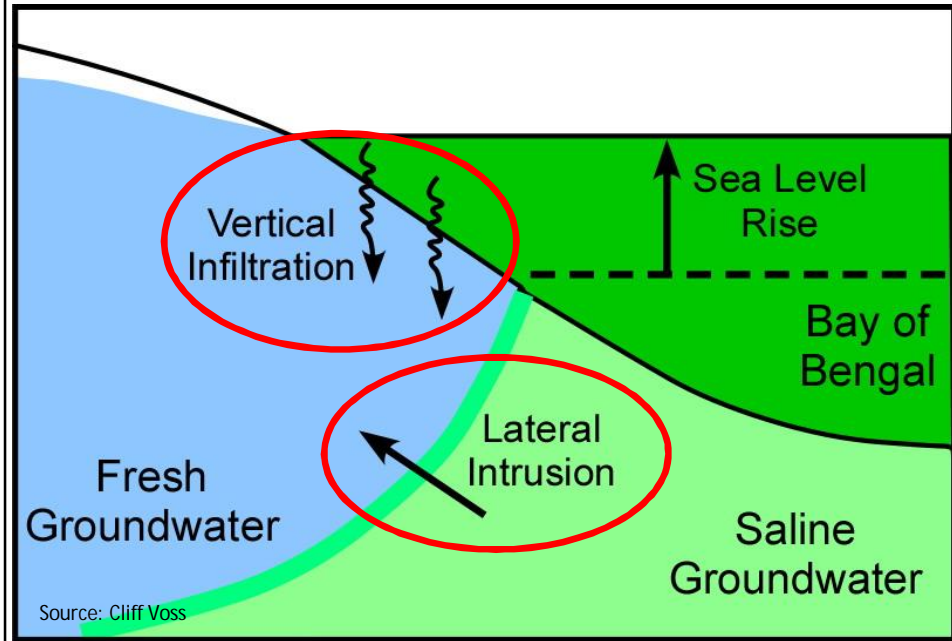

Modes of Salinization due to Sea-Level Rise

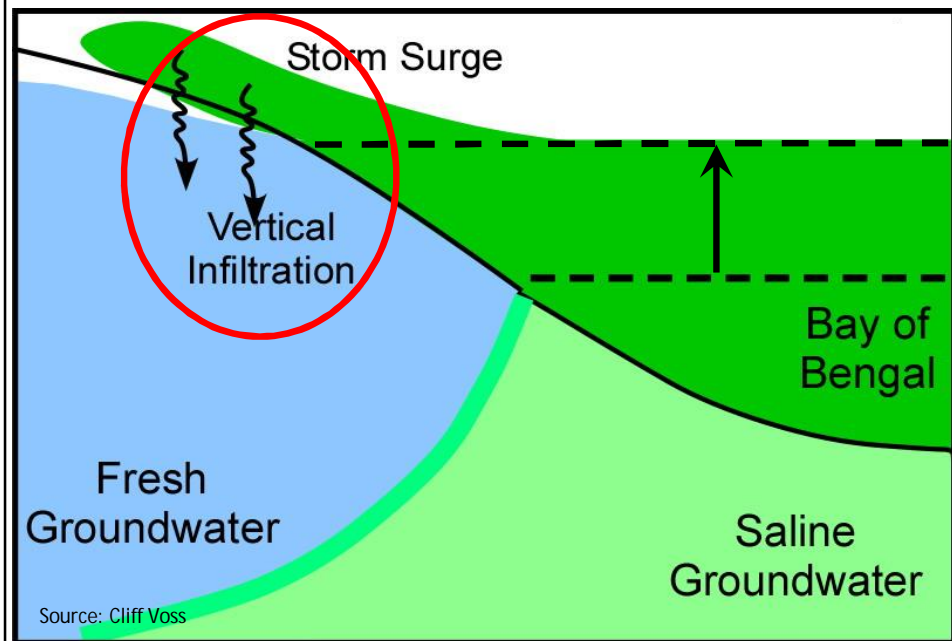

Salinization due to Pumping

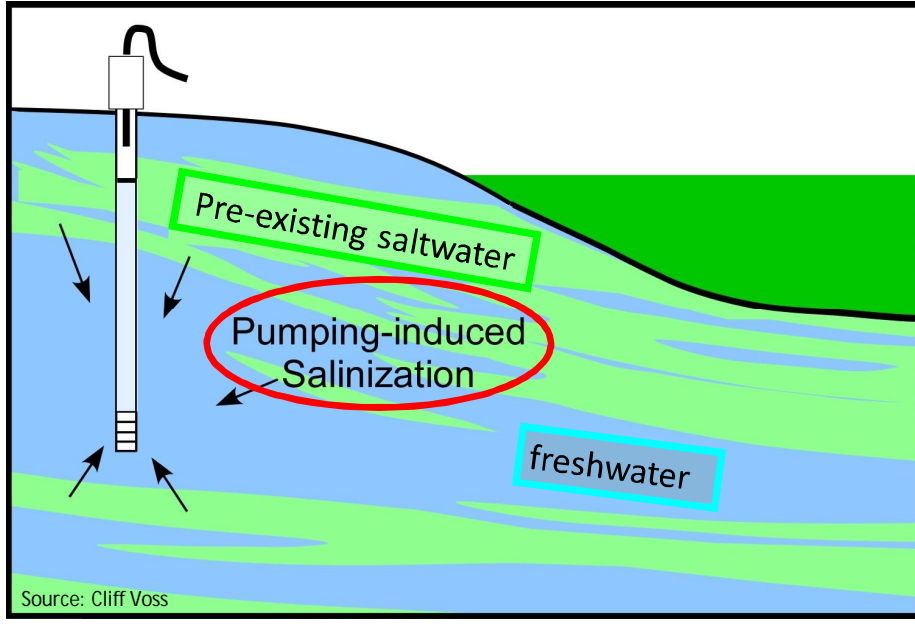

Salinisation processes at local scale

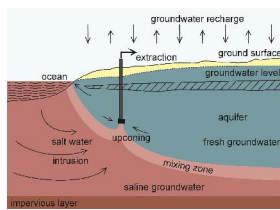

Salt water intrusion groundwater

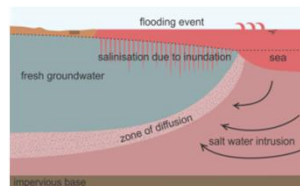

Inundation saline seawater

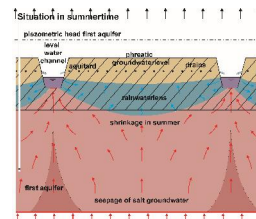

Shallow rainwaterlens

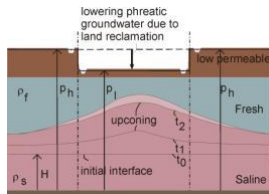

Upconing low-lying area

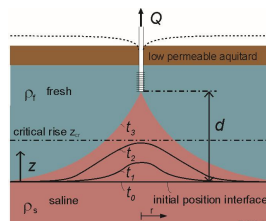

Upconing extraction

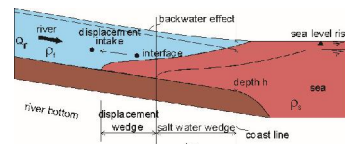

Salt water intrusion surface water

Salinization processes in the coastal zone: combination

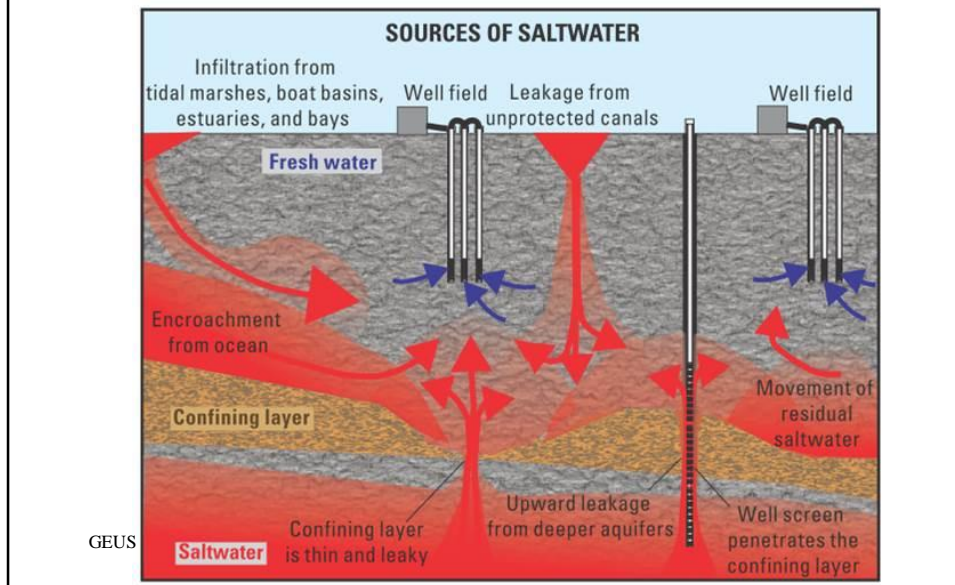

Regions with brackish and saline groundwater at shallow and intermediate depths

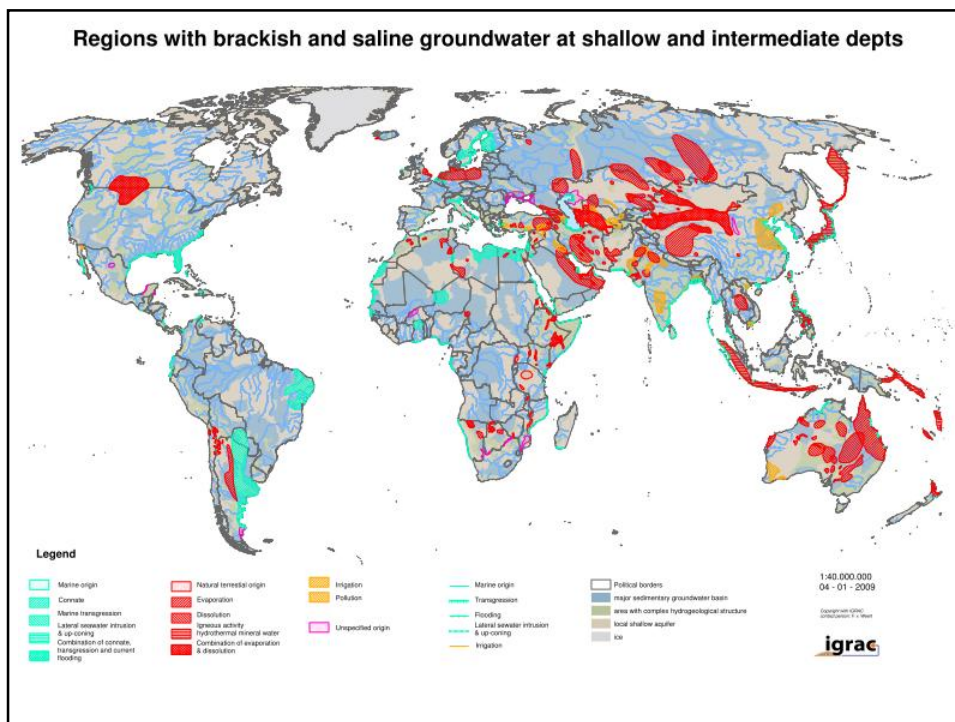

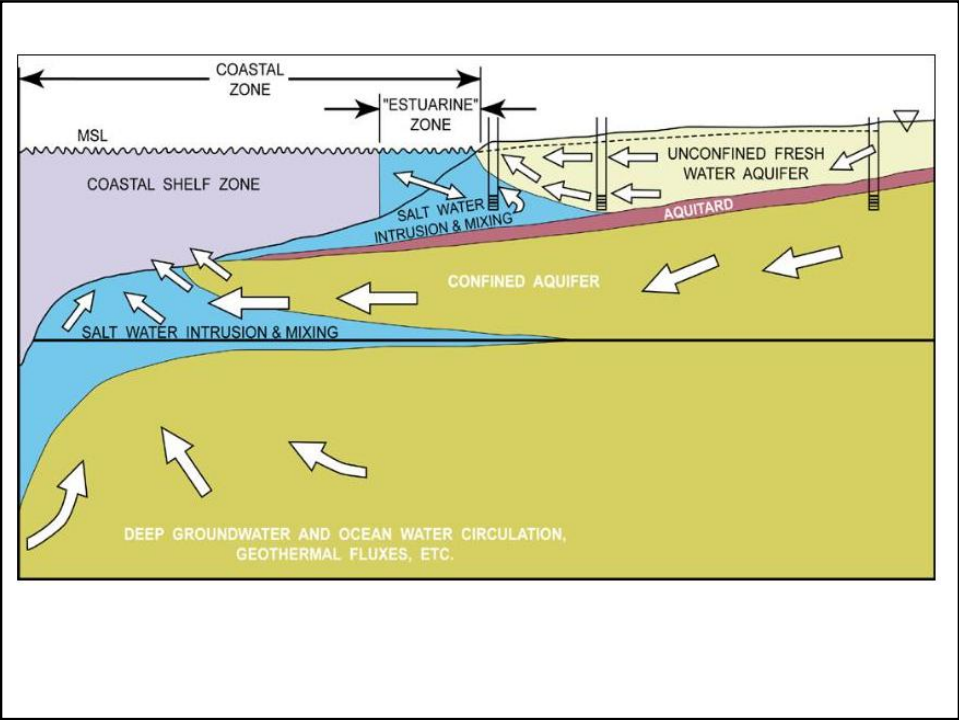
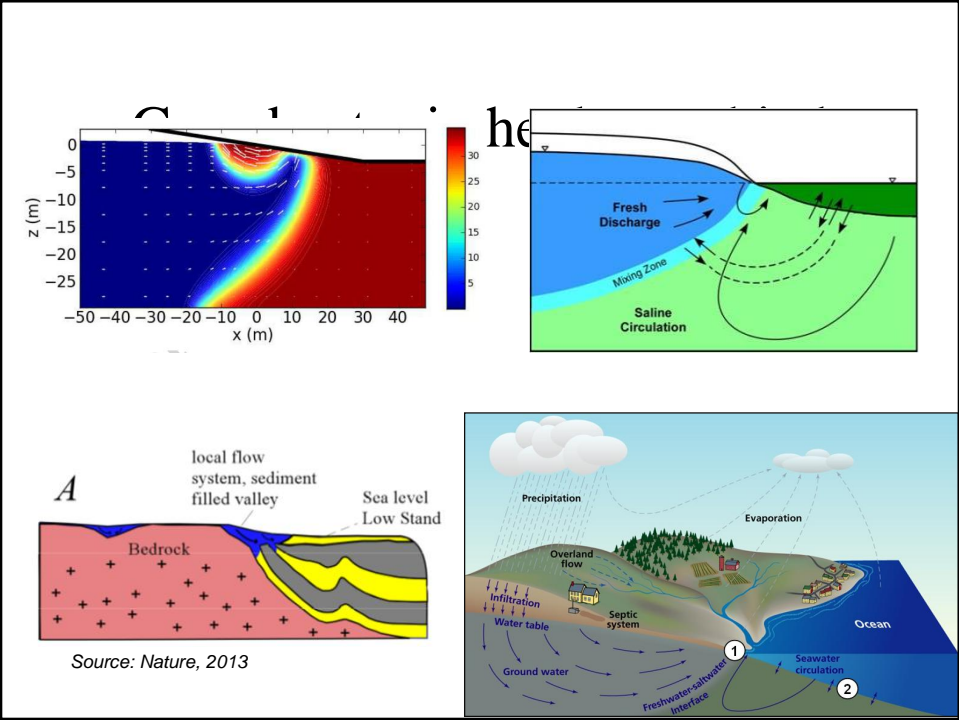

Biscayne aquifer, Florida USA: Henry's case

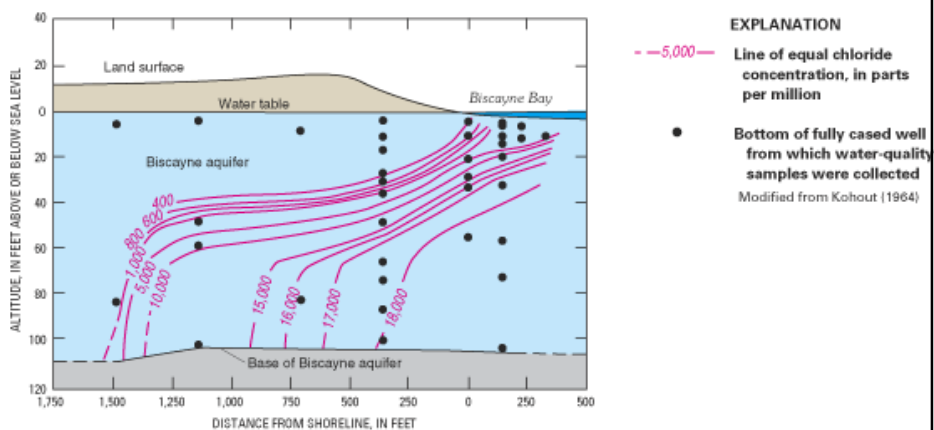

Definition of salt water intrusion

Numerical model: Henry's case

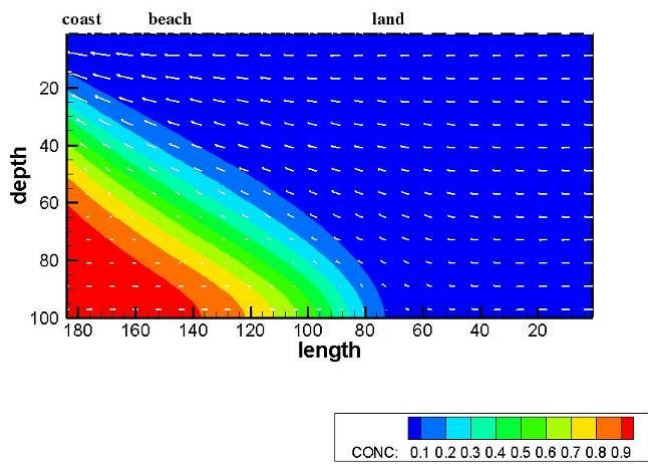

Definition of salt water intrusion

Numerical model: Henry's case

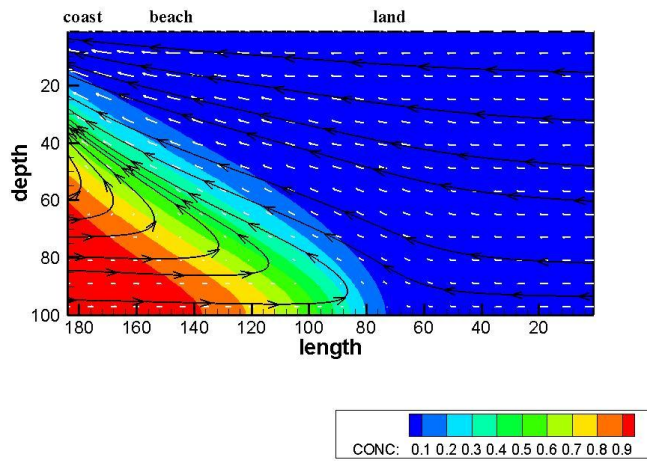

Sea level rise and salt water intrusion

Effect sea level rise on groundwater system in coastal zone

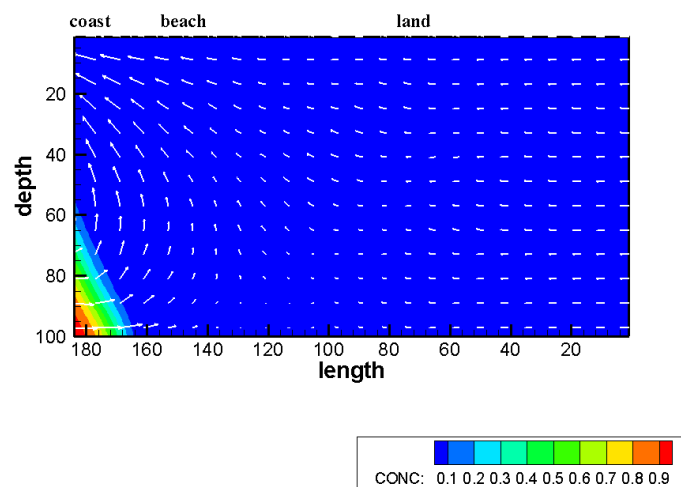

Sea level rise and salt water intrusion

Effect sea level rise on groundwater system in coastal zone

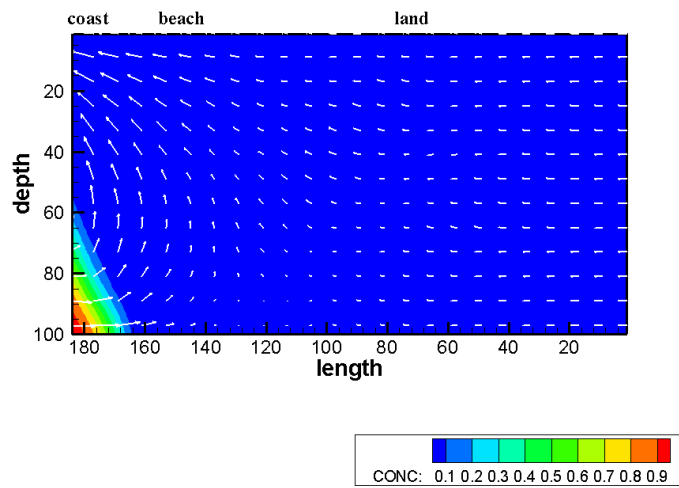

Sea level rise and salt water intrusion

Impact of sea level rise on a coastal groundwater system:

a conceptual model of saltwater intrusion

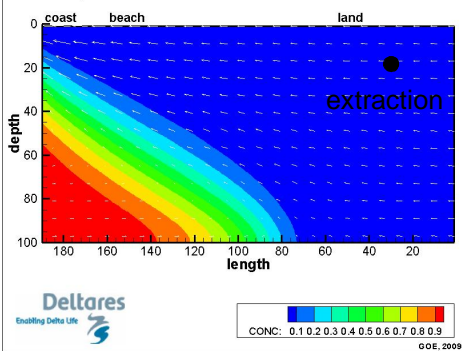

Impact of sea level rise on a coastal groundwater system:

a conceptual model of saltwater intrusion

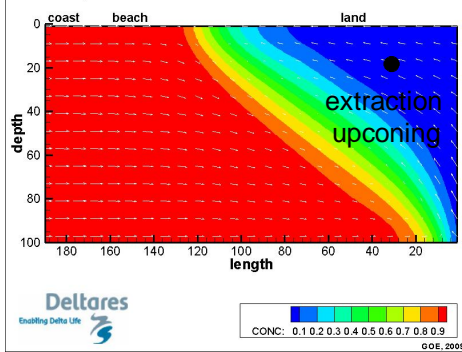

Types of extraction systems

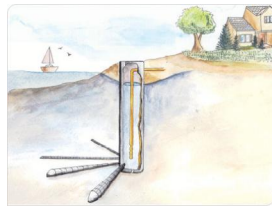
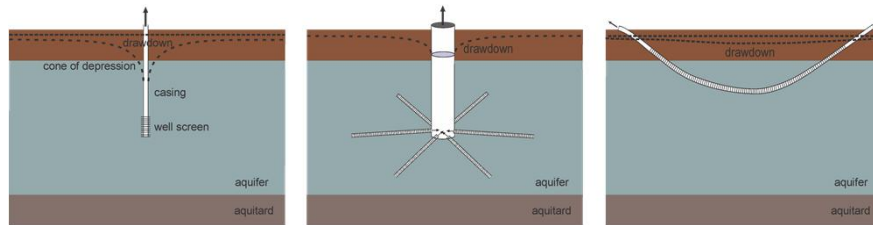

Salt water intrusion

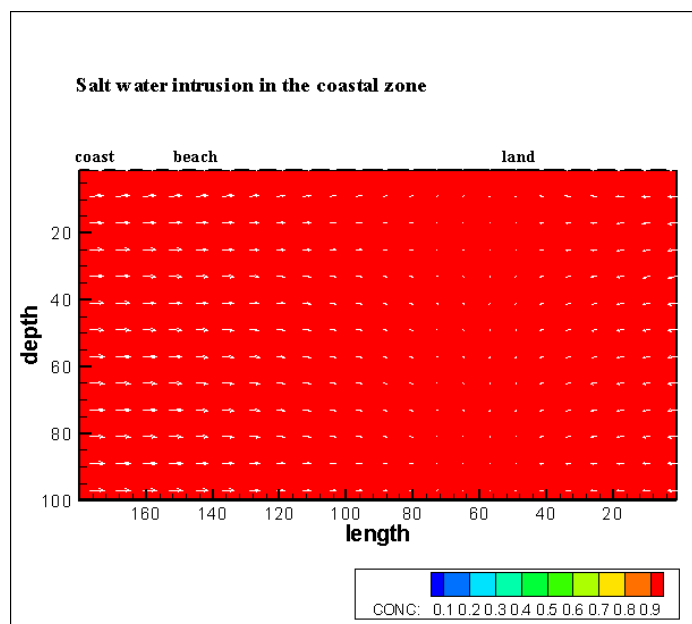

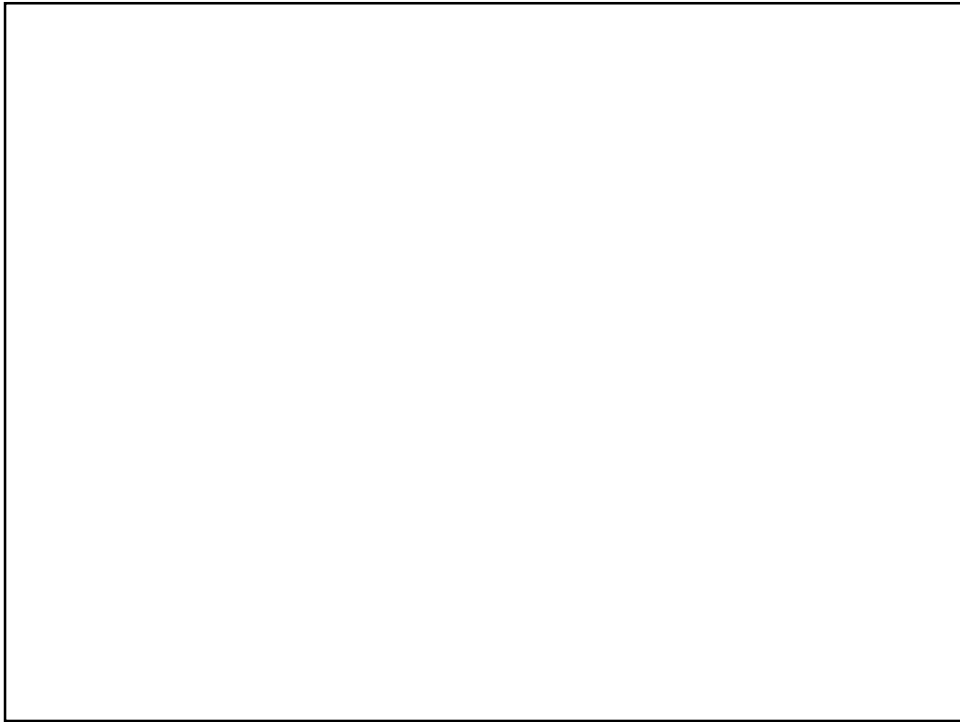

Water on Earth

Some serious developments:

"shortage of drinking water will be one of the biggest problems of the 21th century"

"in 2025, two third of world population will face shortage of water"



In 1 liter ocean: about 35 gr salt



In 1 liter ocean: about 35 gr salt



In 1 liter Dead Sea water (Jordan/Israel) : about 280 gr salt



In 1 liter drinking water: about 0.15 gr salt is allowed



Jan van Scorel
20140121



Grass can grow well in water with a salt content equal to about 6.5 gr salt in 1 liter water



Fresh-brackish-saline groundwater

Ions		[mg/L]
Negative ions	Cl^-	19000
	SO_4^{-2}	2700
	HCO_3^-	140
	Br^-	65
Total negative ions		21905
Positive ions	Na^+	10600
	Mg^{+2}	1270
	Ca^{+2}	400
	K^+	380
Total positive ions		12650
Total Dissolved Solids (TDS)		34555

Definition fresh-brackish-saline groundwater

Main type of groundwater	Chloride concentration [mg Cl ⁻ /L]
oligohaline	0 - 5
oligohaline-fresh	5 - 30
fresh	30 - 150
fresh-brackish	150 - 300
brackish	300 - 1000
brackish-saline	1000 - 10.000
saline	10.000 - 20.000
hyperhaline or brine	≥ 20.000

Type	[mS/cm]	[mg TDS/L]	Drinking- or irrigation water
Non-saline or fresh water	<0.7	<500	Drinking and irrigation water
Slightly saline	0.7 - 2	500-1.500	Irrigation water
Moderately saline	2 - 10	1.500-7.000	Primary drainage water and groundwater
Highly saline	10 - 25	7.000-15.000	Secondary drainage water and groundwater
Very highly saline	25 - 45	15.000-35.000	Seawater is about 35000 TDS mg/L
Brine	>45	>35.000	n.a.

EOS

Examples of equations of state

Knudsen (1902)

$$\rho_{(S,T)} = 1000 + 0.8054S - 0.0065(T - 4 + 0.2214S)^2$$

T < 15 °C, S < 20 ppt

Linear (concentration)

$$\rho_{(C)} = \rho_f \left[1 + \alpha \frac{C_i}{C_s} \right] \quad \text{where } \alpha = \text{relative density difference}$$

Linear (temperature)

$$\rho_{(T)} = \rho_f [1 - \beta(T - T')]]$$

Exponential (temperature, pressure, salt)

$$\rho_{(T,p,\omega)} = \rho_f e^{-\alpha(T-T_0) + \beta(p-p_0) + \gamma\omega}$$

Equation of state (SEAWAT)

$$\rho_{i,j,k} = \rho_f + \frac{\partial \rho}{\partial C} C_{i,j,k}$$

e.g.:

1. conc=35 TDS g/l: DRHODC=0.7143
2. conc=19000 mg Cl-/l: DRHODC=0.001316
(as 1025=1000+0.001316*19000)
3. conc=1: DRHODC=25 (example practicals)

EOS

Density depends on salinity and temperature

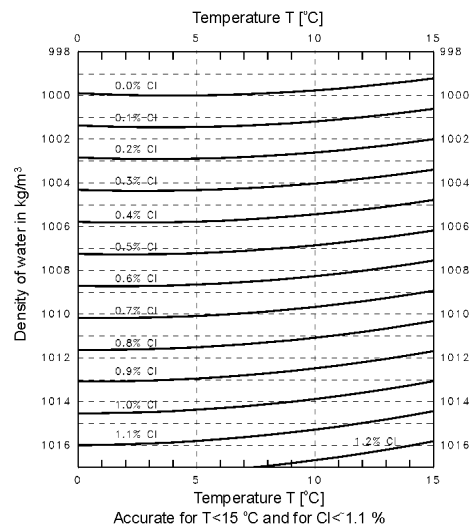

$$\rho_{(S,T)} = 1000 + 0.8054S - 0.0065(T - 4 + 0.2214S)^2 \quad \text{Knudsen (1902)}$$

Density and viscosity depend on temperature

(10°C-160 °C)

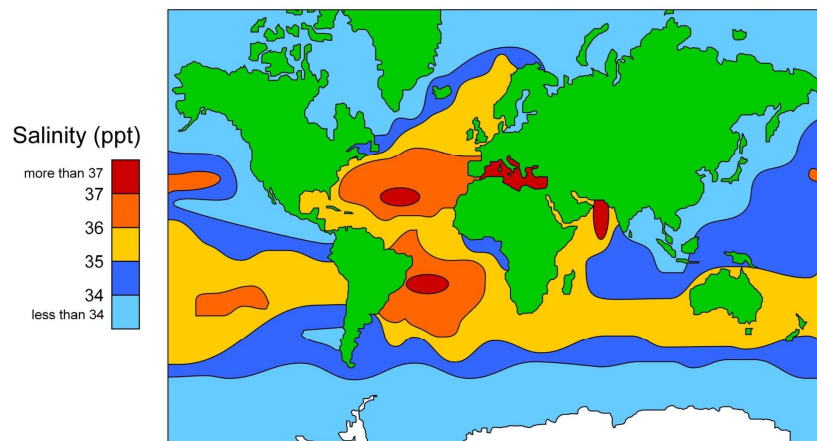
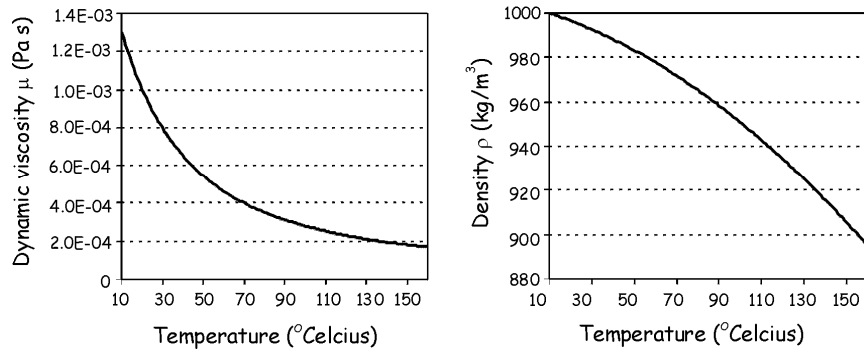

© Copyright 2010. University of Waikato. All Rights Reserved. www.sciencelearn.org.nz

Close relation between chloride concentration and Electrical Conductivity

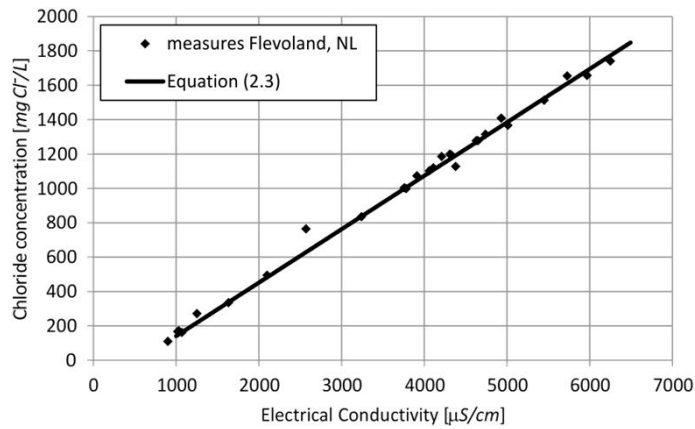

$$Cl^{-} (mg / L) = EC_w (\mu S / cm) \cdot 0.305 - 137$$

Close relation between chloride concentration and Electrical Conductivity

$$10^6 \mu S/cm = 10^3 mS/cm = 1 S/cm$$

$$1 \mu S/cm = 100 \mu S/m$$

ocean water:

~19000 mg Cl-/L or ~34555 mg TDS/L

~5 S/m or ~48 mS/cm

the ratio Cl⁻ over TDS equal to ~0.554, under stable normal seawater environments

A fresh-keeper for Noard Burgum
 The new future for a salinated well field?

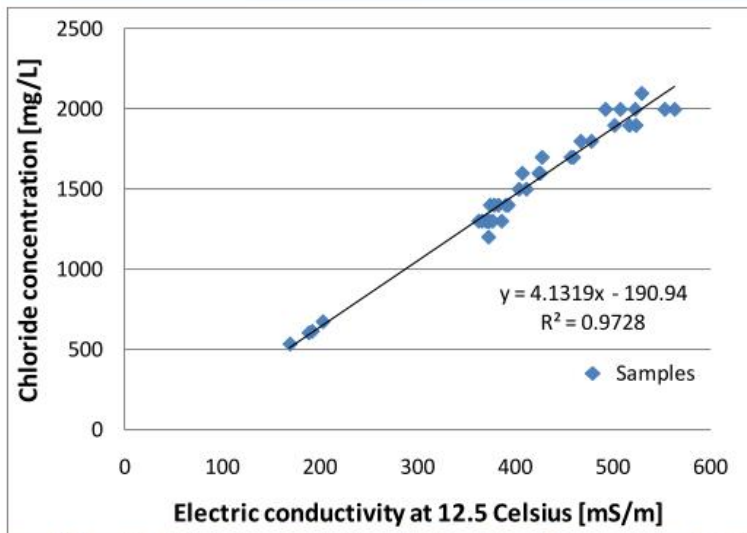

Appendix figure 11: Relation between the electric conductivity and the chloride concentration. For this relation samples from observation well B06D1114 and B06D1087 in between 23-sept-2009 and 9-okt-2010 were plotted.

EC-Chloride

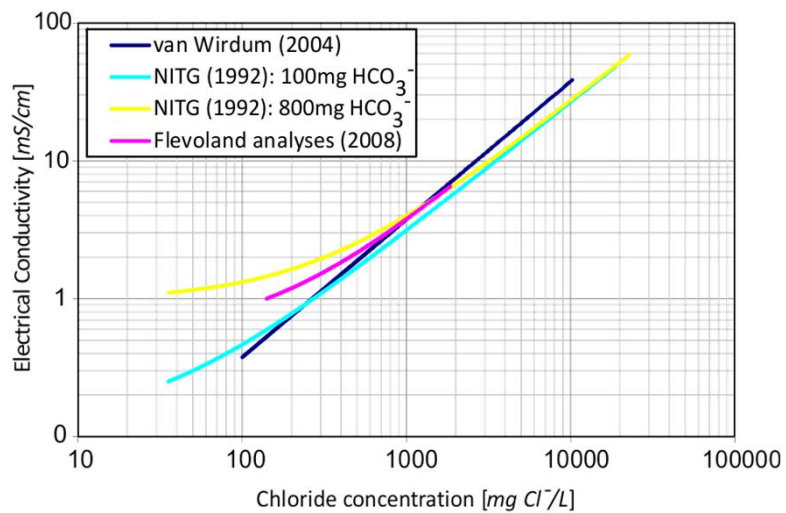

Salt in water is a problem

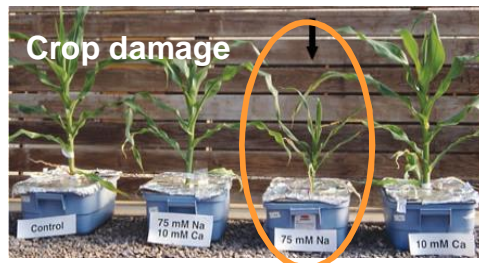
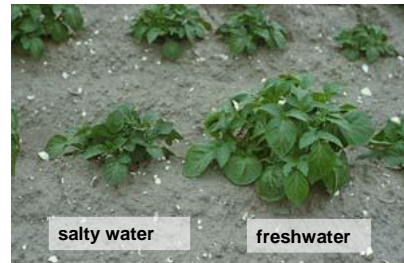

Introduction

Salt in water is a problem for different water management sectors:

-drinking water:

- taste (100-300 mg Cl⁻/l)
- long term health effect
- norm: EC& WHO=150 mg Cl⁻/l (live stock=1500 mg Cl⁻/l)

-industry:

- corrosion pipes
- preparation food

-irrigation/agriculture:

- production crops
- salt damage

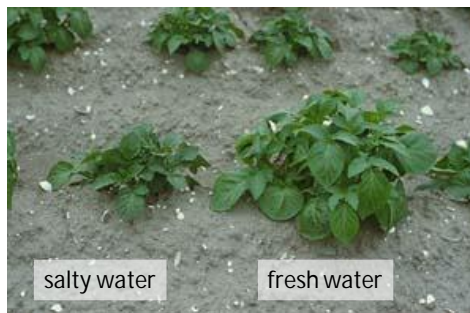

Effects salinisation: salt damage

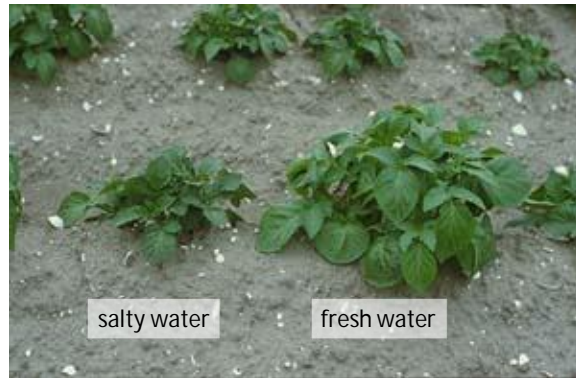

Source: Proefstation voor de Akkerbouw en Groenteteelt, Lelystad

Salt-resistant crops

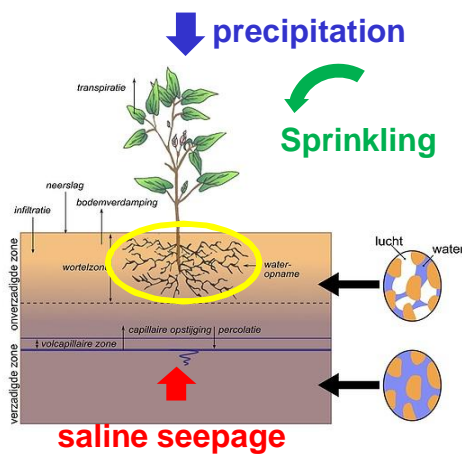

Important parameter:
 Chloride concentration root zone
 Land use
 Sensitivity crops

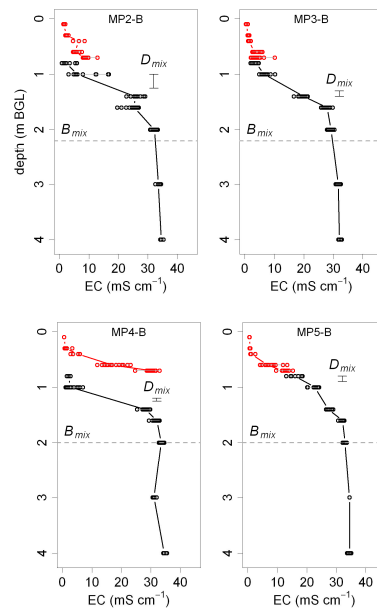

Salt damage to crops

Important parameters:

- Chloride concentration in the root zone
- Land use
- Sensitivity crops

Land use	Threshold value	Gradient root zone (-)
Grass	3606	0.0078
Potatoes	756	0.0163
Beet	4831	0.0057
Grains	4831	0.0058
Horticulture	1337	0.0141
Orchard (trees)	642	0.0264
Bulb	153	0.0182

Source: Roest et al., 2003 en Haskoning

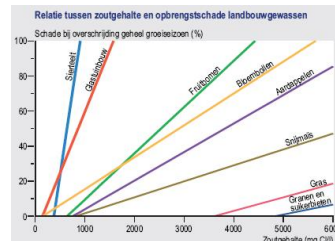

Source: MNP, 2005

Salt damage to crops



Relation between salt concentration and damage to crops

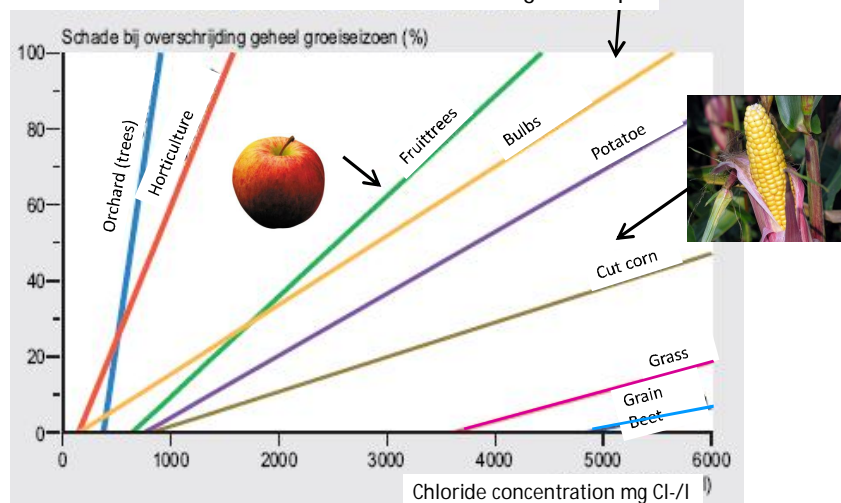

Source: MNP, 2005

	Soil moisture		Irrigation water	
	Limit	Gradient	Limit	Gradient
Crop	mg/l Cl	%/mg/l Cl	mg/l Cl	%/mg/l Cl
Potatoe	756	0.0163	202	0.0610
Grass	3606	0.0078	962	0.0294
Sugar beat	4831	0.0057	1288	0.0212
Cut Corn	815	0.0091	217	0.0343
Grains	4831	0.0058	1288	0.0218
Fruit trees	642	0.0264	171	0.0991
Orchard (trees)	378	0.1890	101	0.7086
Vegetables	917	0.0158	245	0.0591
Horticulture	1337	0.0141	356	0.0527
Bulbs	153	0.0182	41	0.0683

Introduction

Why is salinisation a pressing problem?

- 30% of world population lives <100 km from coastline
- economic and tourist activities increase
- enormous increase in extraction
- irreversible process
- increase saltwater intrusion problem world-wide:
 - upconing
 - salt water wedge
 - decrease outflow q_0
- climate change:
 - sea level rise
 - natural groundwater recharge

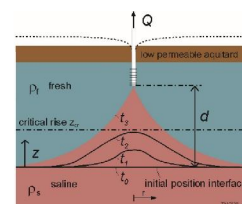
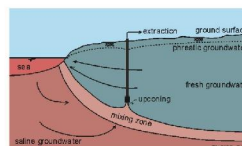
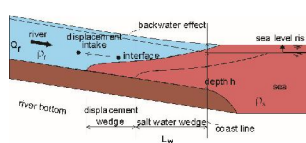

Processes that accelerate salt water intrusion:

- Sea level rise
- Land subsidence
- Human activities

Threats for:

- drinking water supply in dunes:
 - upconing of saline groundwater
 - decrease of fresh groundwater resources
 - recharge areas reduction
- agriculture:
 - salt damage to crops: salt load and seepage
- water management low-lying areas:
 - flushing water channels
- ecology



The water footprint of products

global averages

1 kg wheat	1 m³ water
1 kg rice	3 m³ water
1 kg milk	1 m³ water
1 kg cheese	5 m³ water
1 kg pork	5 m³ water
1 kg beef	15 m³ water



[Hoekstra & Chapagain, 2008]





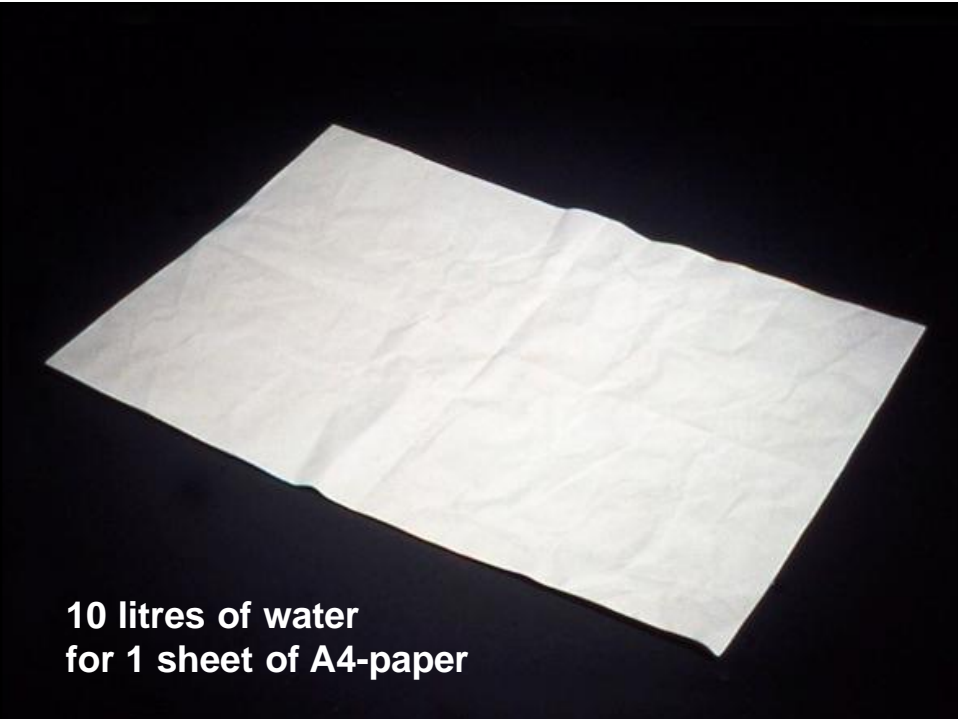

Question:

Demand fresh water per capita per day?:

- a. 10 litre/day
- b. 25 litre/day
- c. 100 litre/day
- d. 200 litre/day

Water withdrawal as % of total available water

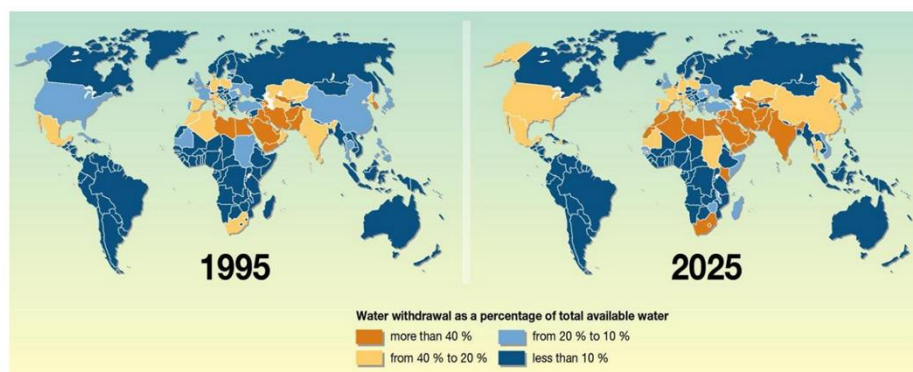

Population growth 1990-2025

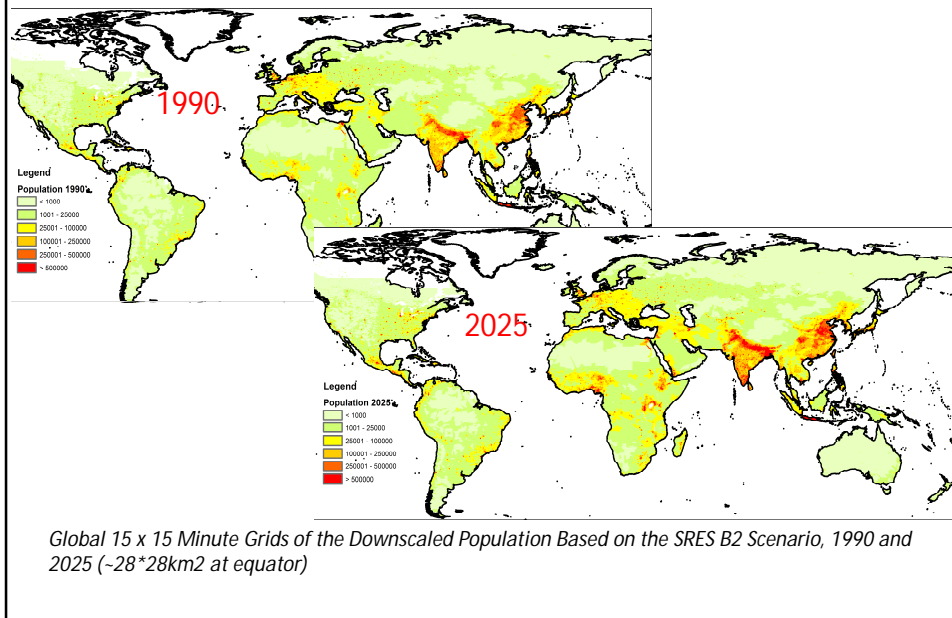

Introduction

Reasons and drawbacks of using groundwater

Advantage:

- no seasonal effects
- high quality
- low storage costs
- large quantities
- no spatial limitations

Disadvantage:

- high extraction costs
- local droughts
- high mineral content
- land subsidence....
- salt water intrusion !

Serious overexploitation coastal aquifers worldwide

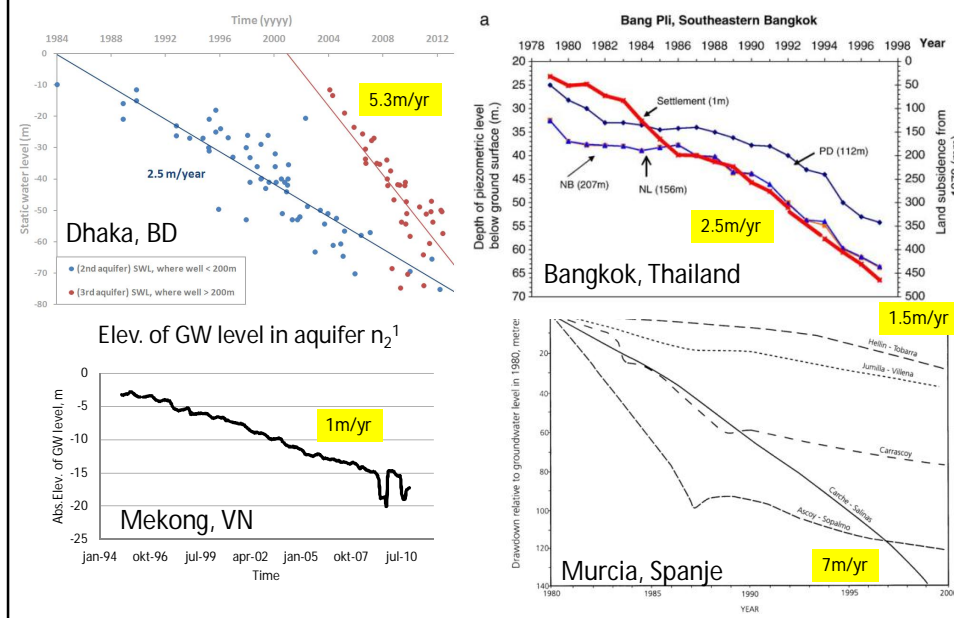

What causes the land to subside?

Natural causes (geological processes):

- *Loading* of the earth's crust by ice sheets, sediment (delta's), the ocean/sea
- *Compaction* of older sediments after sedimentation

Anthropogenic causes (human-induced processes):

- *Oil/gas extraction* (usually relatively deep)
- *Groundwater extraction* (usually moderately deep)
- *Drainage* of soils \Rightarrow oxidation of peat, soil compaction

Why discriminating between human-induced and natural processes?

- Magnitude
- Cooping strategy (mitigation versus adaptation)

Possible causes of land subsidence in the Mekong

Land subsidence is a **natural process** in deltas.

Land subsidence can be accelerated by **human activities** that increase **physical loading** or change the **hydrogeological situation**

Total subsidence is the cumulative effect of all processes.

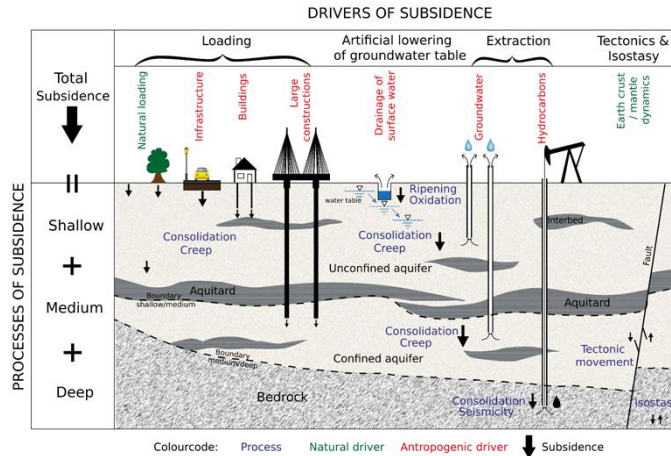

Minderhoud et al. 2015

Impacts





Evidence of subsidence in the Mekong delta



Shallow subsidence, visible around founded bridges and buildings

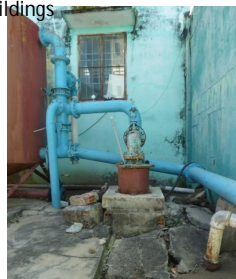

Deeper subsidence, visible by protruding pumping wells



Challenges deltaic areas

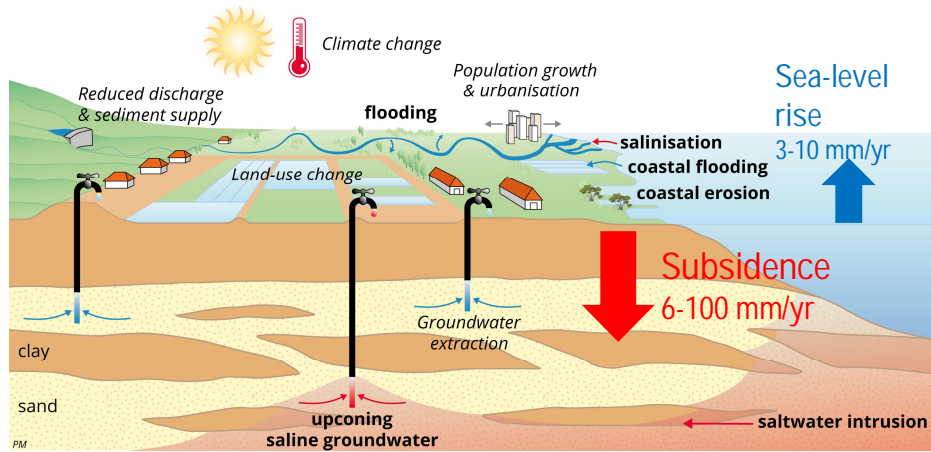

Minderhoud, 2019

Land subsidence in deltas is a global problem

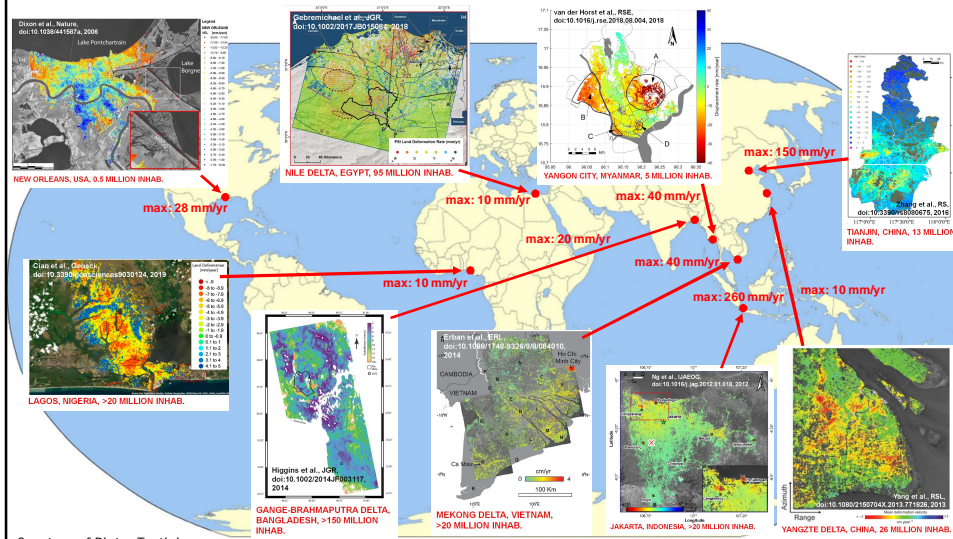

Courtesy of Pietro Teatini

Examples of some major coastal cities

The subsidence issue is underestimated

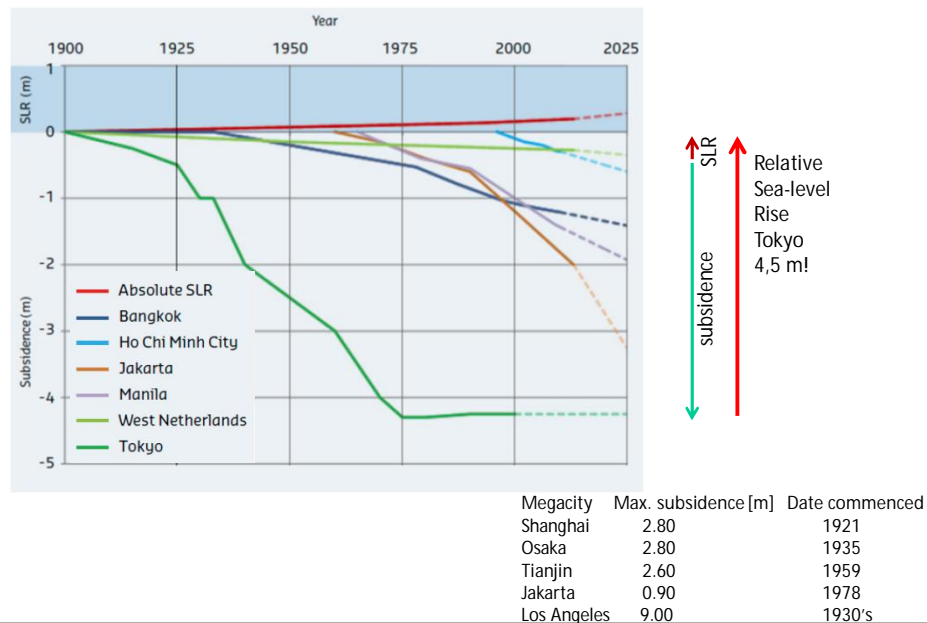

Four case studies

What lessons can we learn:

1. California, USA
2. Bangkok, Thailand: implementing policies to reduce extraction
 - Groundwater act (1977)
 - Mitigation of Groundwater Crisis and Land subsidence (1983)
 - Groundwater Tariff and Conservation Fee (1985)
3. Jakarta, Indonesia: until today no mitigation measures on groundwater extraction
4. Mekong Delta, Vietnam

Case 1: Land subsidence San Joachim Valley, CA, USA

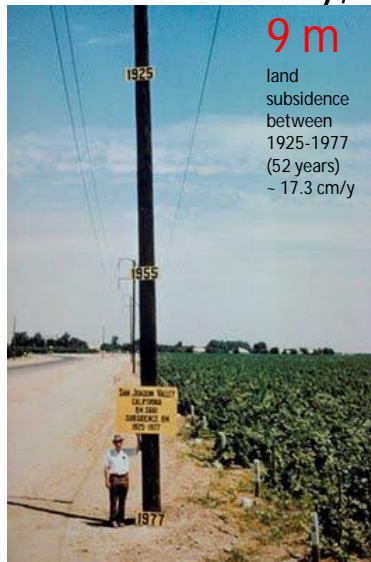

9 m since 1930s
San Francisco



Case 2: Bangkok

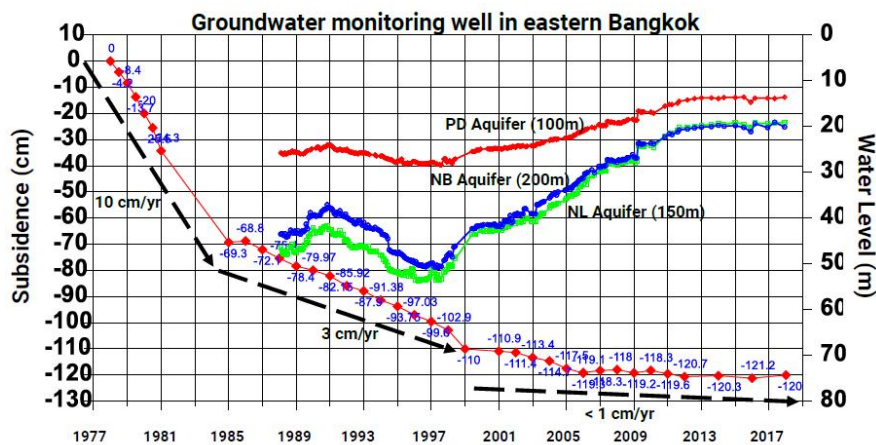

Courtesy: Chadaporn Busarakum

Case 3: Jakarta



Cumulative subsidence map of Jakarta 1974-2010

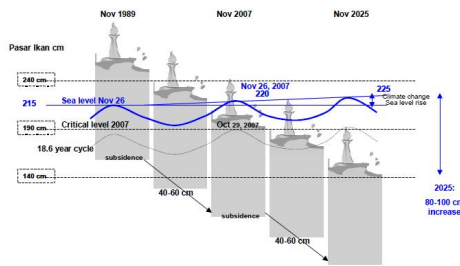
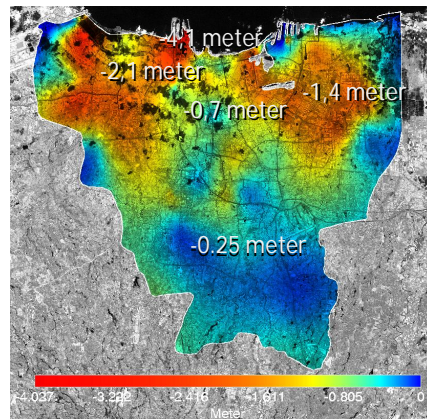

Brinkman and Hartman, 2009

Subsidence rates: up to 25 cm/year

Case 4: Groundwater overexploitation in Mekong Delta



Aquaculture (shrimp farms) need an enormous quantity of fresh groundwater

shrimp farms

The Mekong delta is sinking

Estimated InSAR-derived subsidence rates (cm/yr)

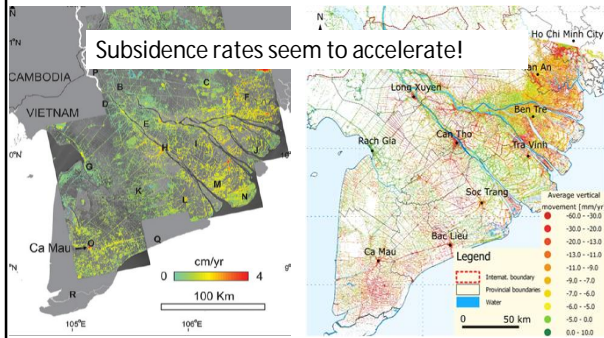

Subsidence rates seem to accelerate!

2006-2010:
Up to 4 cm/yr

2014-2019:
Up to 6 cm/yr



Evidence on the ground

Erban et al., 2014. Environ. Res. Lett. EU Copernicus EMSN062

25 years of simulated groundwater extraction

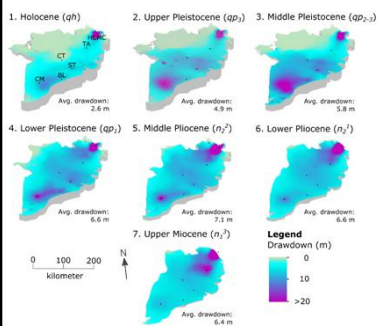

Groundwater extraction is much larger than groundwater recharge, and replenishment is very limited

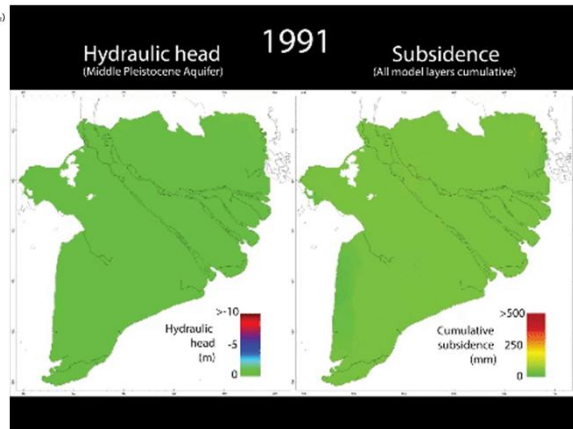

Extraction-induced subsidence is accelerating!

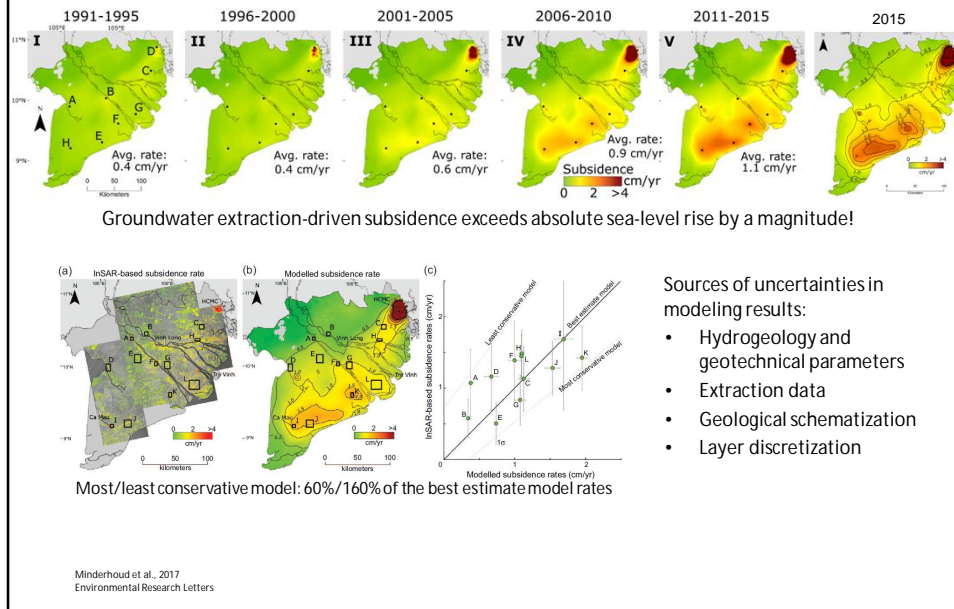

The future of the Mekong delta?

The decisions of today, will determine tomorrow

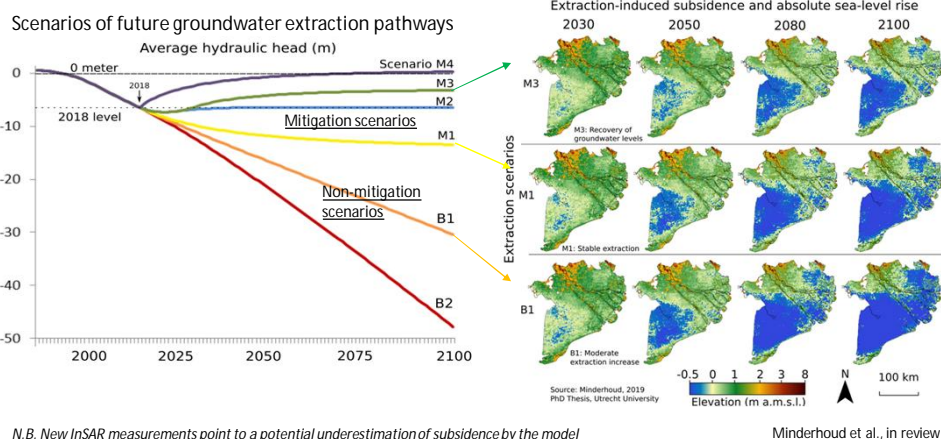

Regional distribution of Holocene Sea-level Changes

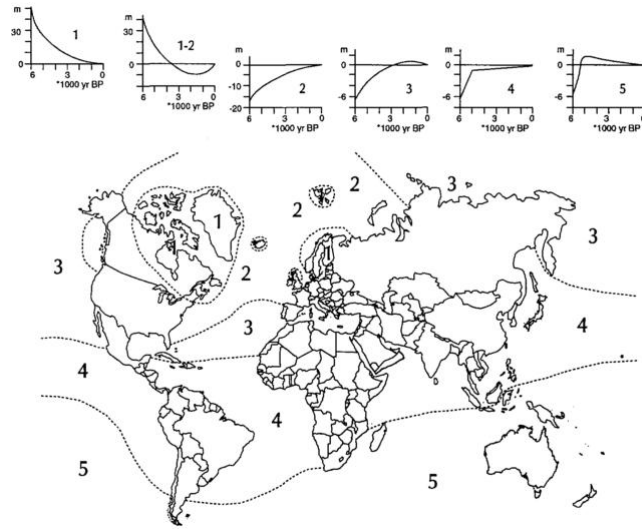

Source: Pirazzoli, P.A. & Pluett, J., 1991. *World Atlas of Holocene Sea-level Changes*. Elsevier Oceanography Series, Vol. 58

Illustration of climate and non-climate driven processes that influence sea level along coasts

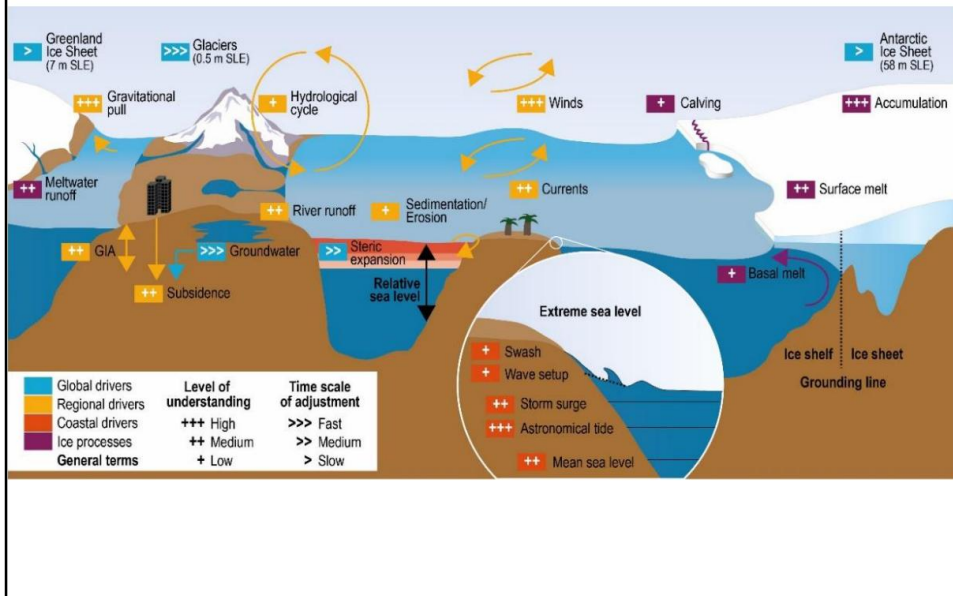

KNMI sea level projections and historic observations in the Zeespiegelmonitor

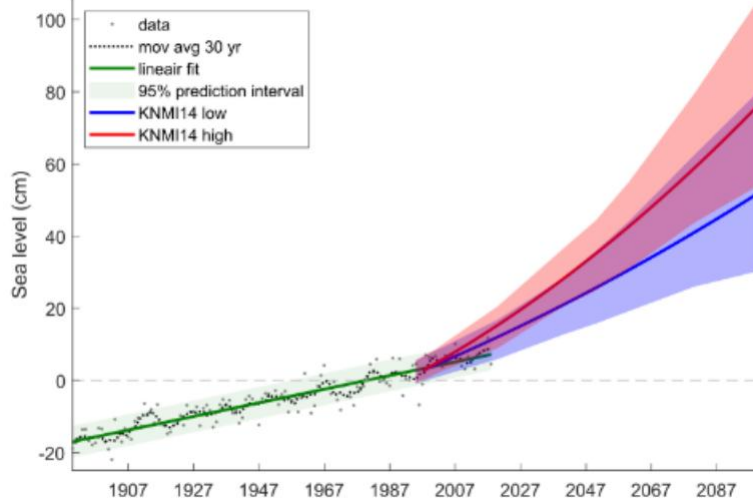

Hurk, B. van den, Geertsema, T., n.d. An assessment of present day and future sea level rise at the Dutch coast.

KNMI sea level projections and historic observations in the Zeespiegelmonitor

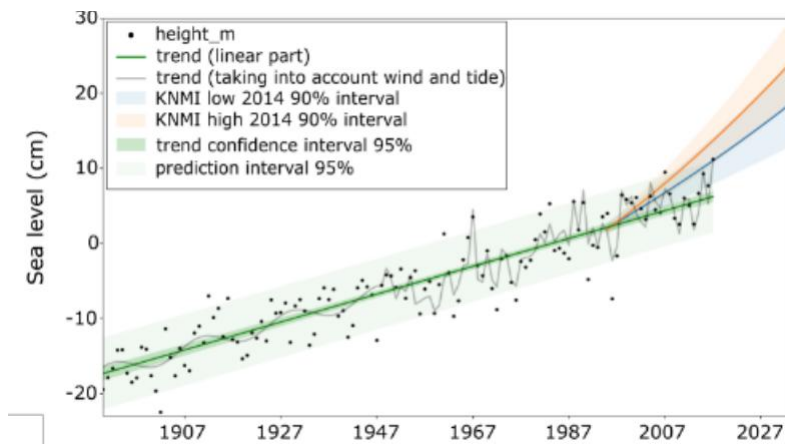

Areas vulnerable to sea level rise

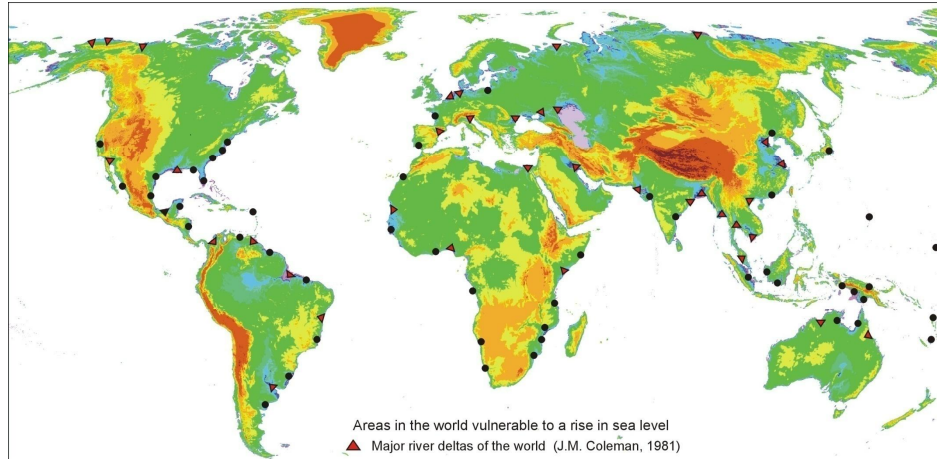

The Netherlands: low-lying lands

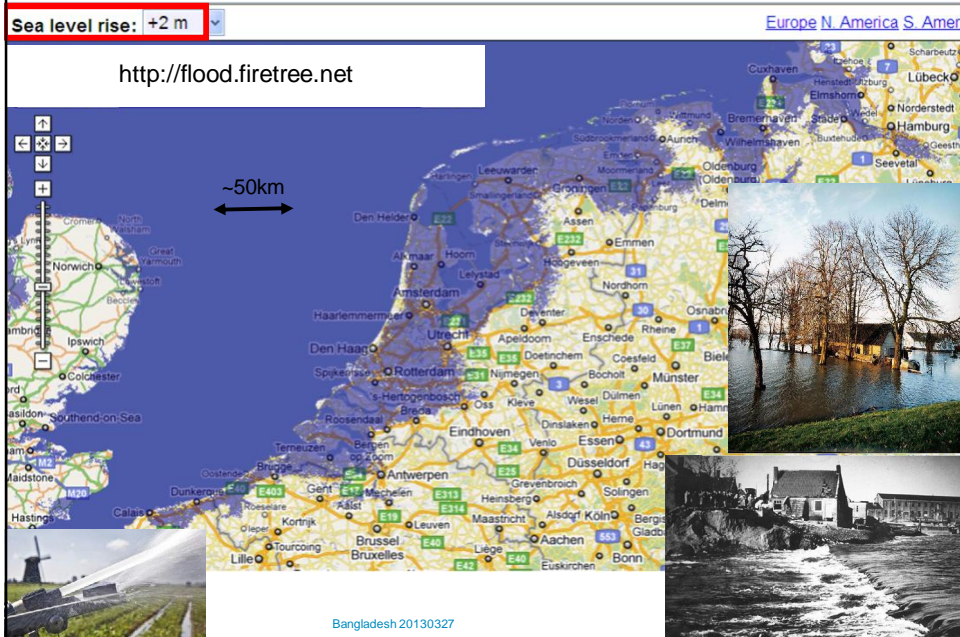

Saline seepage leads to:

- Salinization and eutrophication of surface waters
- Salinization of shallow groundwater
- Salinization of root zone (crop damage)

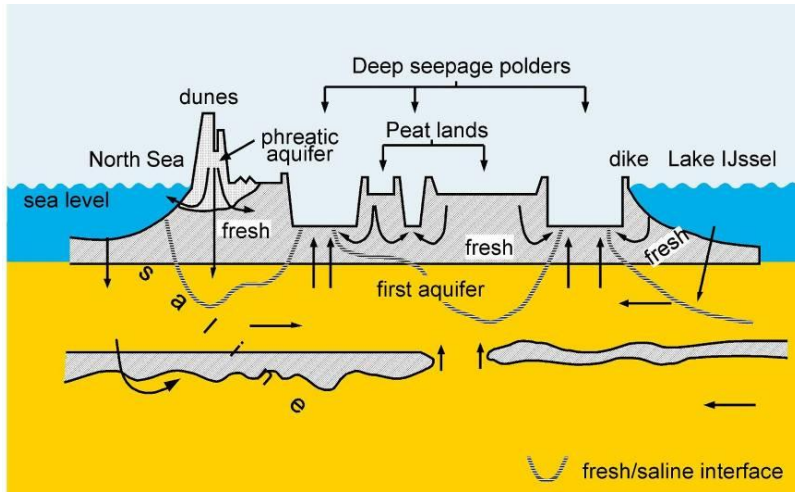

From fresh water outflow to salt water inflow

Historical subsidence of the ground surface in Holland

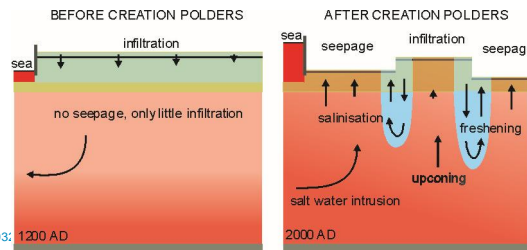
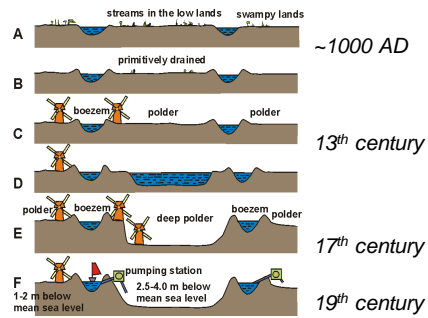
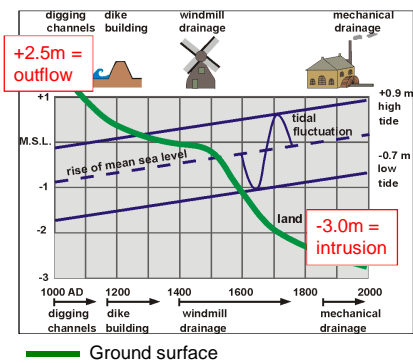

Bangladesh 201303

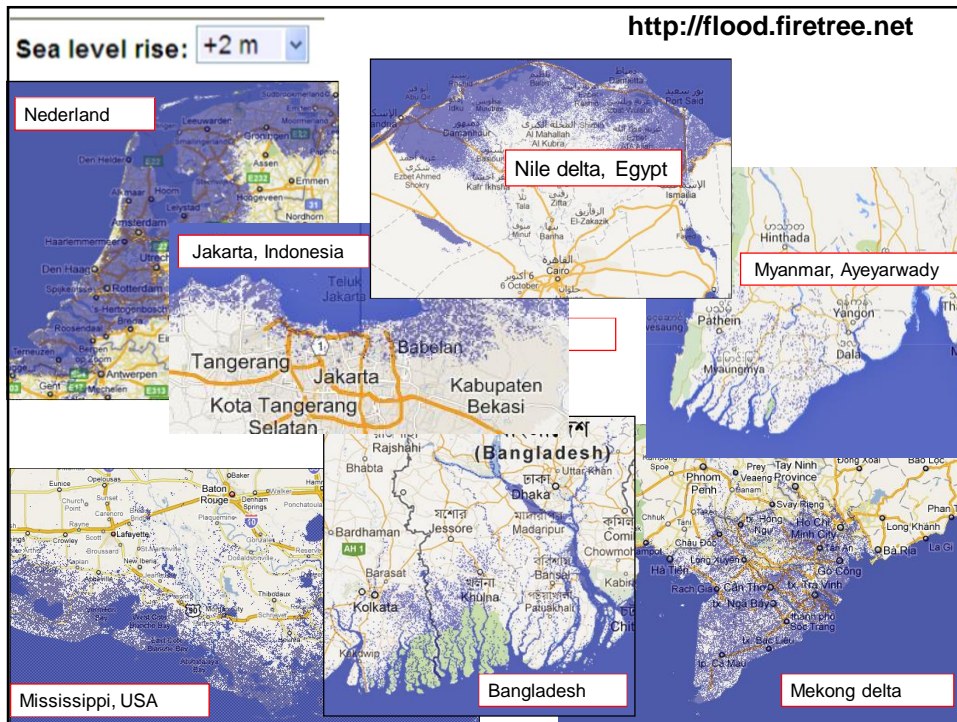

World map of topography and bathymetry showing known occurrences of fresh and brackish offshore groundwater



Post et al., Nature, 2013

Genesis and preservation

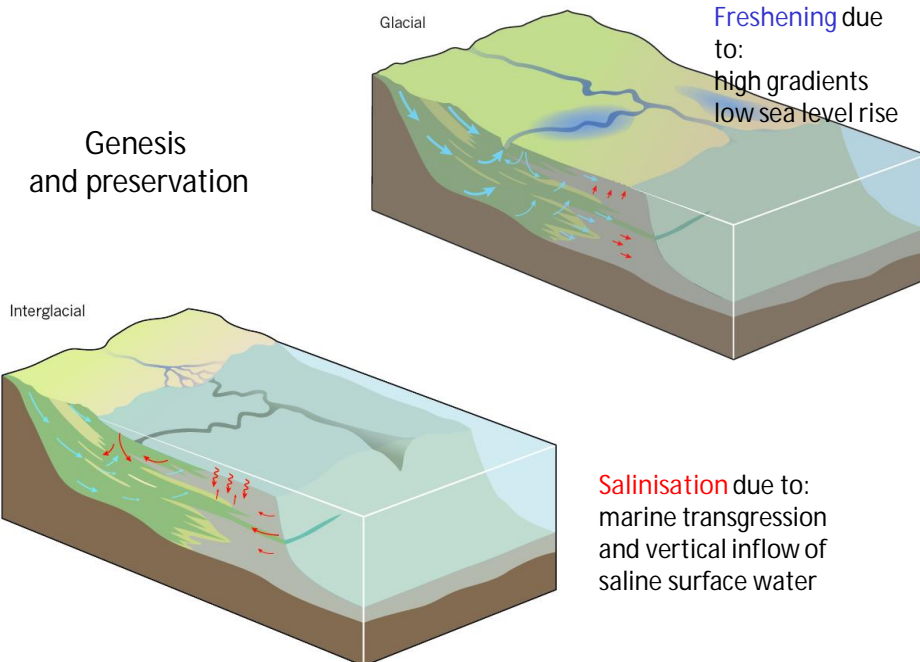

Source: Nature, 2013

Possible locations of offshore (submarine) groundwater

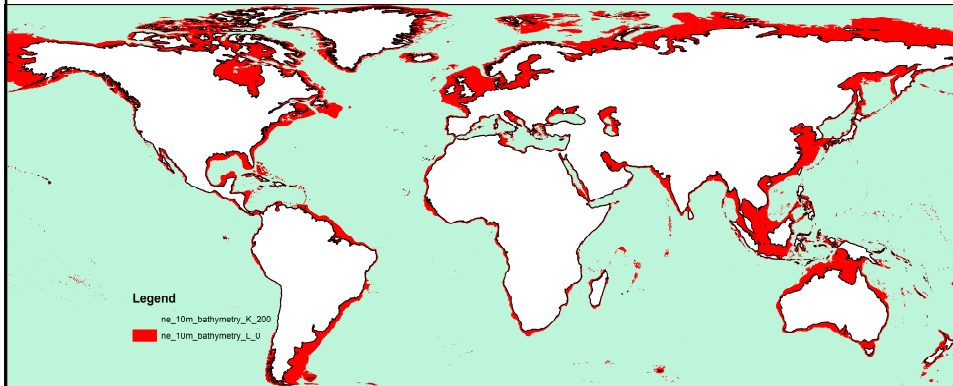

Coastal zone cases around the world Occurrence related to dynamic sea-levels and coastlines

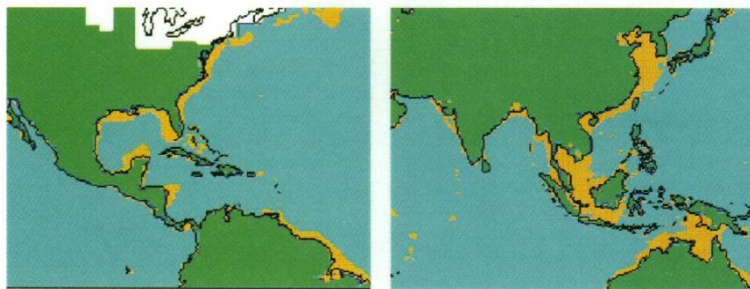

Exposed continental shelves

Peltier, *Science*, 1994

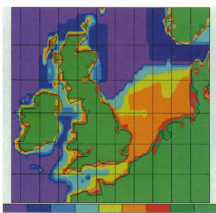

Inundated (kyr BP)

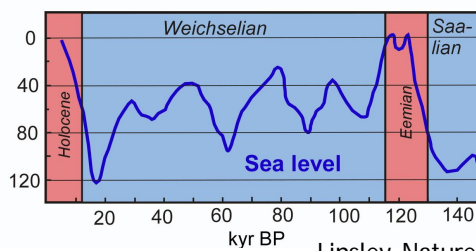

Linsley, *Nature*, 1996

Global overview of inferred key metrics and cross sections of well-characterised vast meteoric groundwater reserves

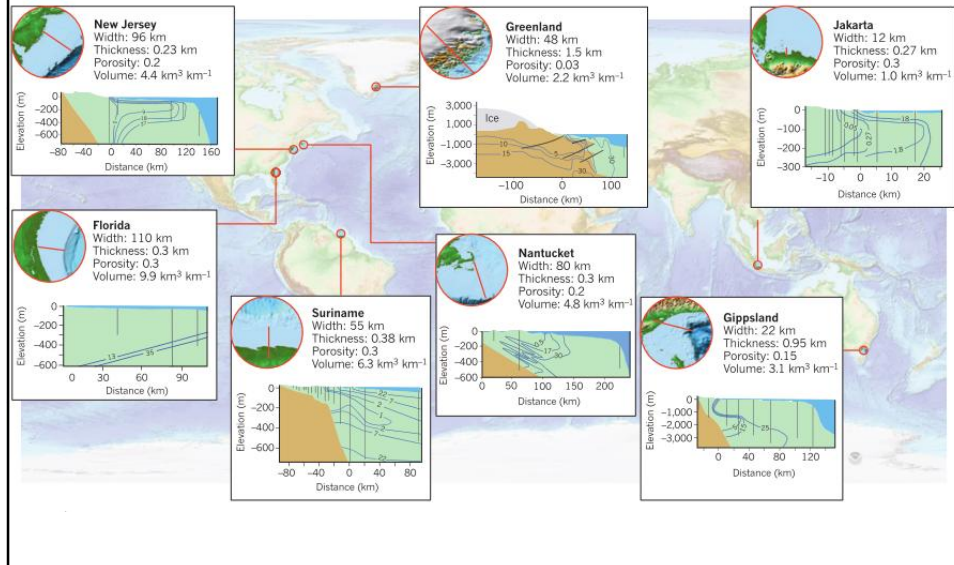

My first density dependent groundwater flow and solute transport model in 1990!

The Dutch groundwater system under stress

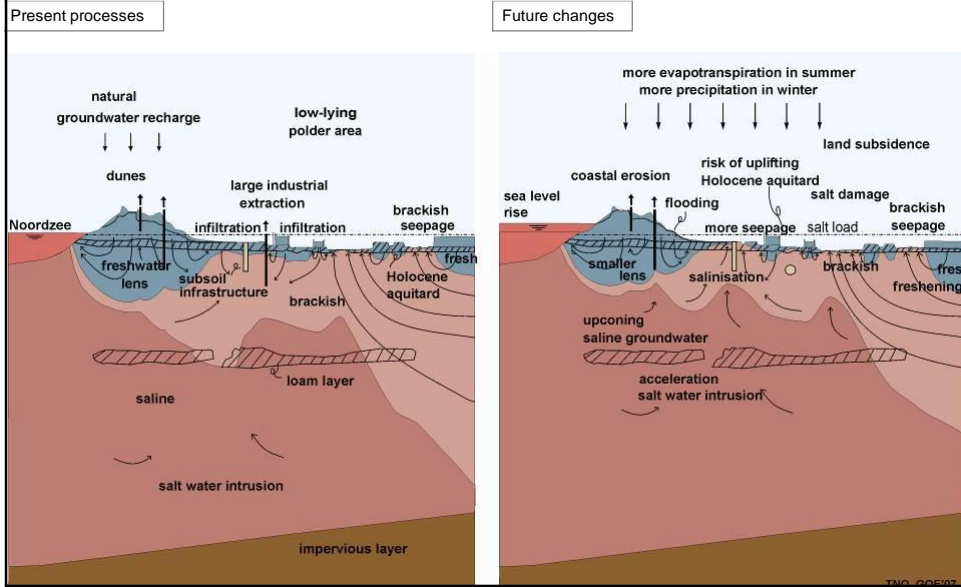

Saltwater intrusion in the Netherlands

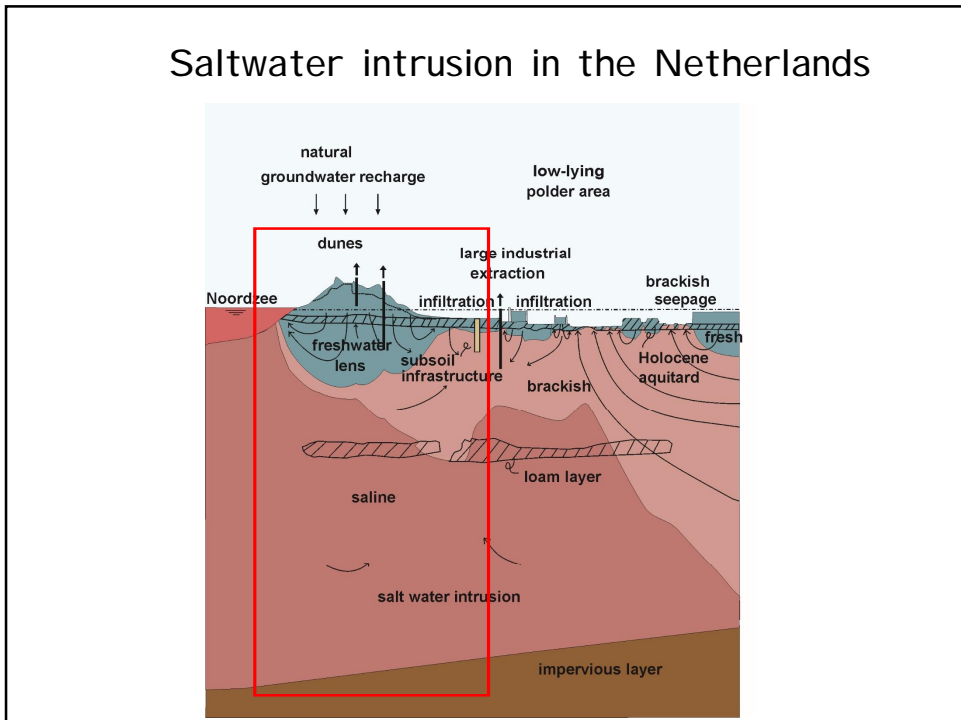

Saltwater intrusion in the Dutch coastal zone

Position profile through Amsterdam Waterworks, Rijnland polders and Haarlemmeer polder

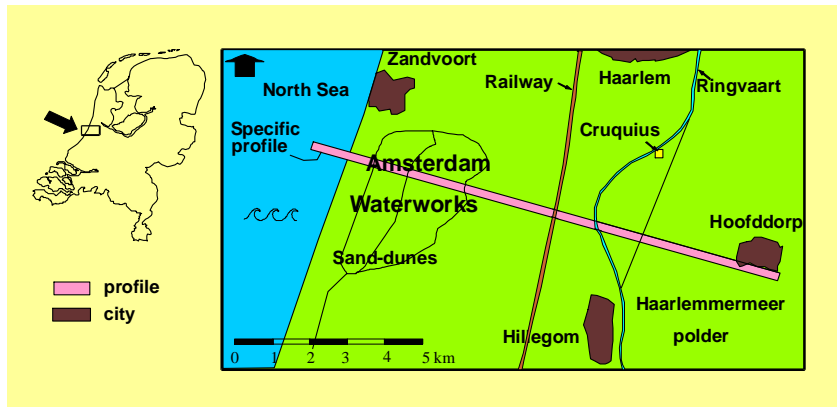

The polder system

A polder is:

a sophisticated system to drain the excess of water in a low-lying area

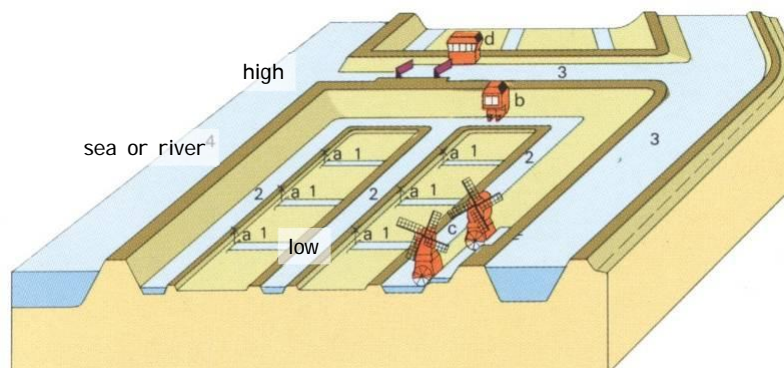

Geometry, subsoil parameters, boundary conditions

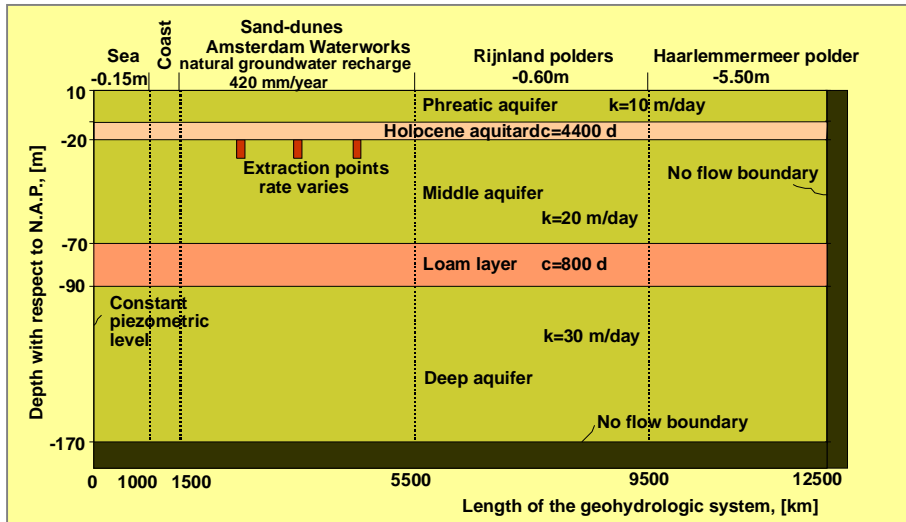

Saltwater intrusion in the Dutch coastal zone

Groundwater extractions out of the middle aquifer in the sand-dune area of Amsterdam Waterworks

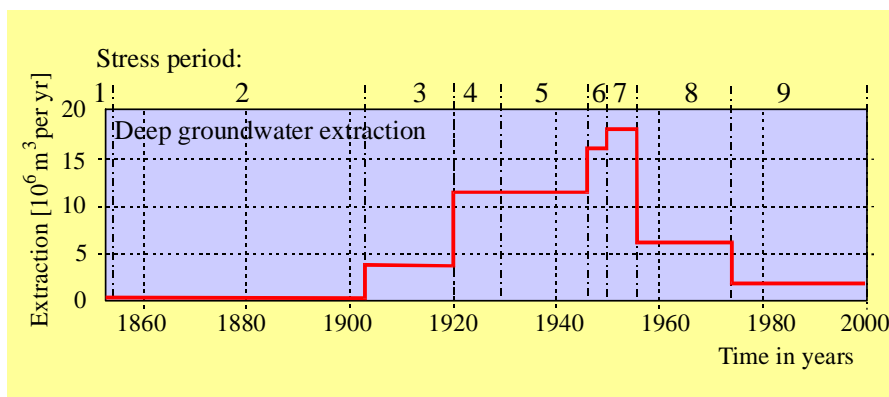

Upconing of brackish-saline groundwater

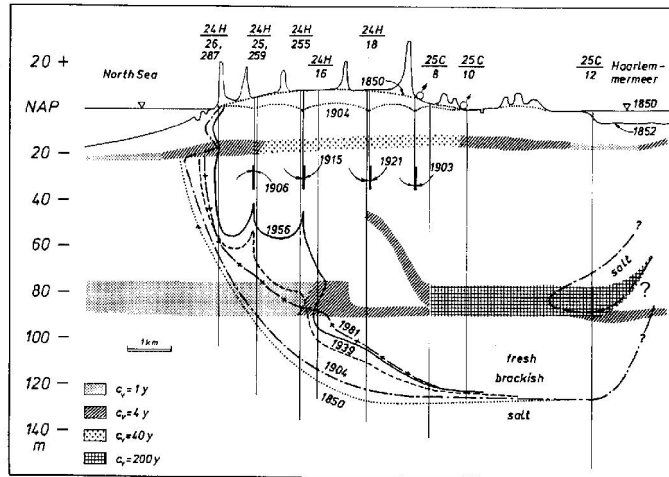
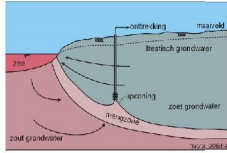

Stuyfzand, 1993

Saltwater intrusion in the Dutch coastal zone

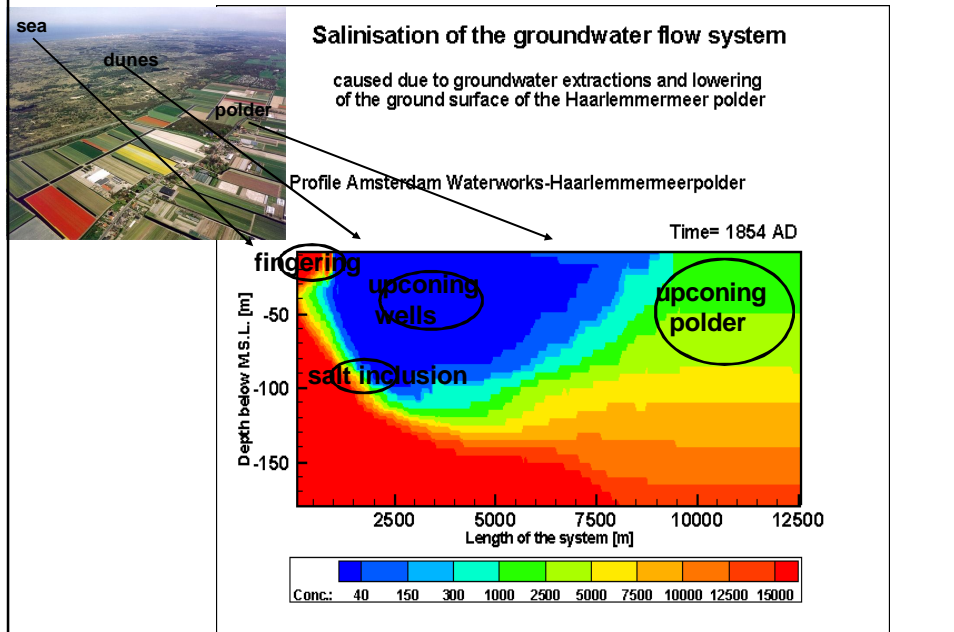

Saltwater intrusion in the Dutch coastal zone

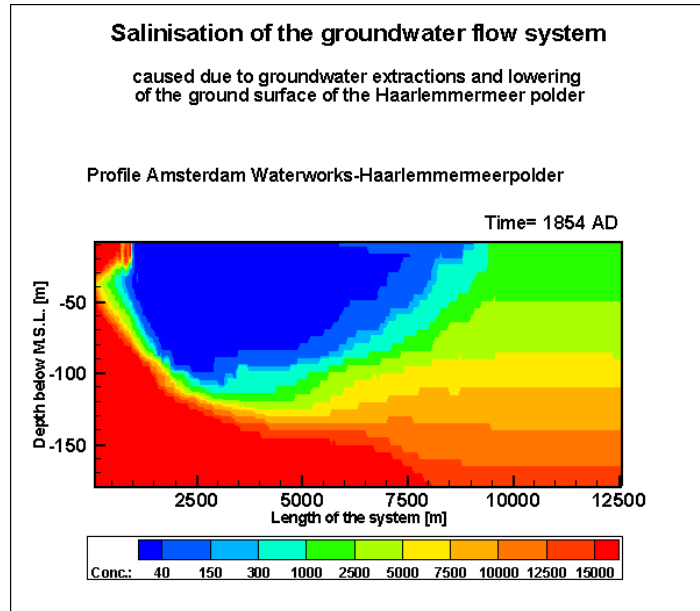

Palaeo hydrogeological modelling

Palaeo-modeling salt water intrusion during the Holocene: an application to the Netherlands

*J.R. Delsman, K. Hu-a-ng, P.C. Vos, P.G.B. de
Louw, G.H.P. Oude Essink and M.F.P. Bierkens*

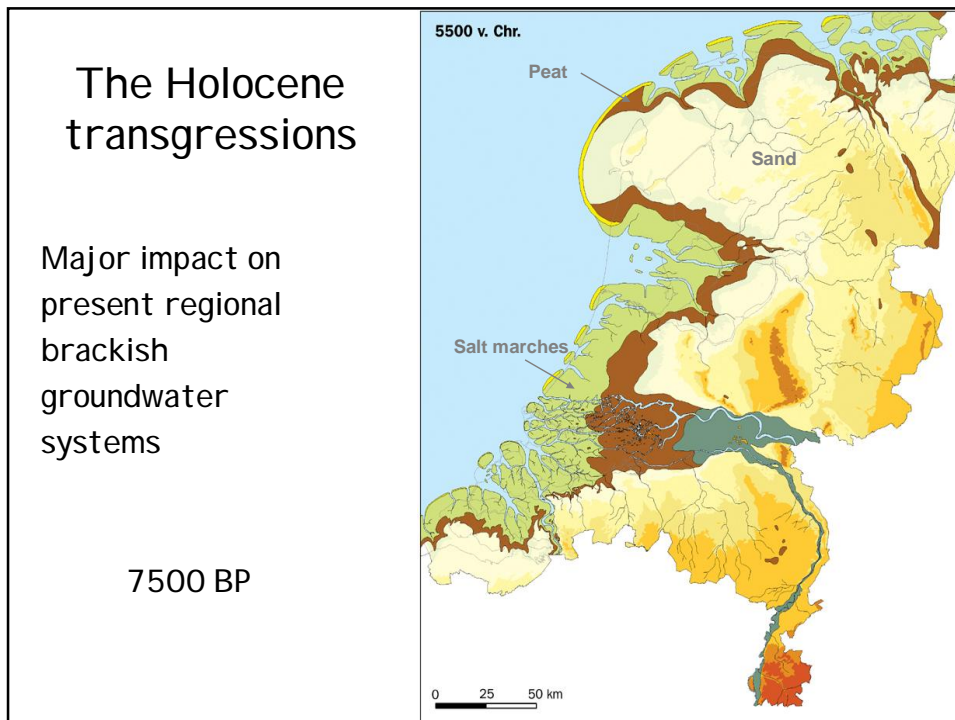
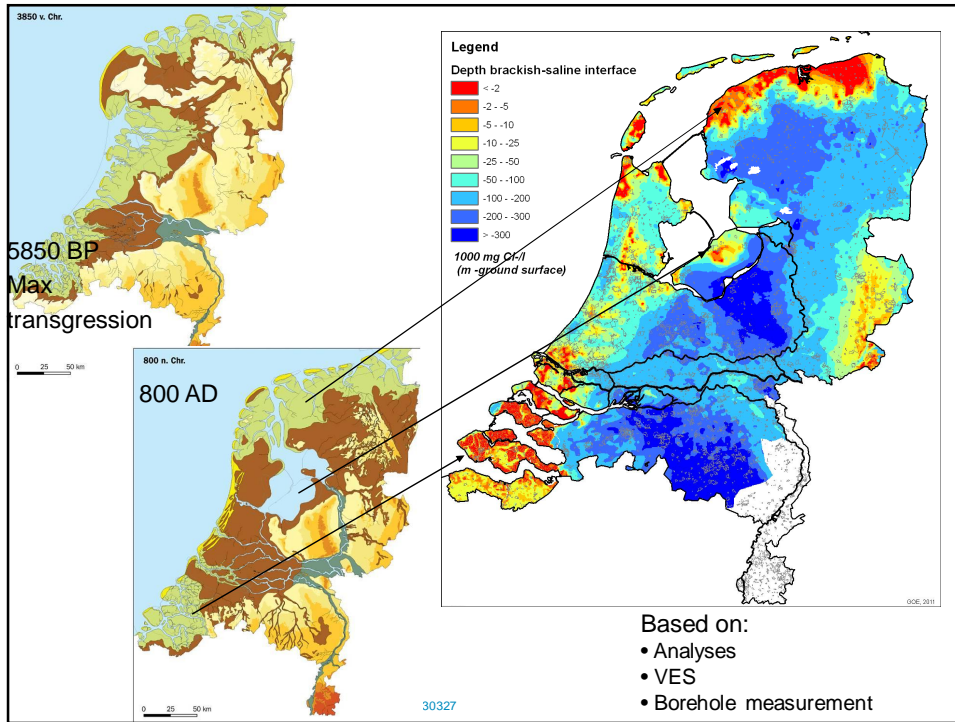

The Holocene transgressions

Major impact on present regional brackish groundwater systems

7500 BP

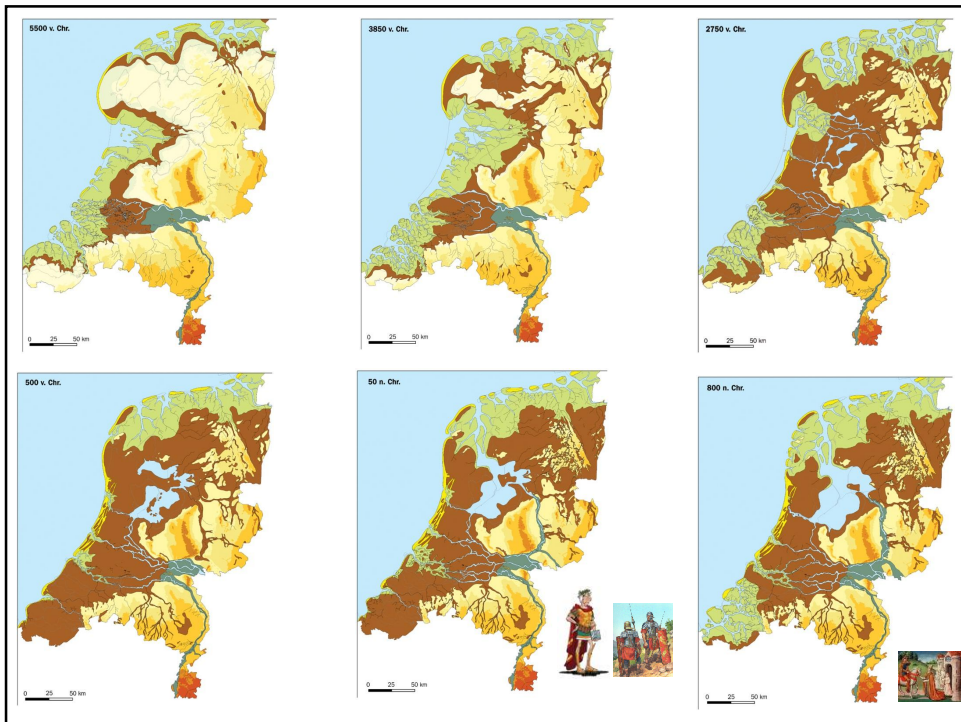
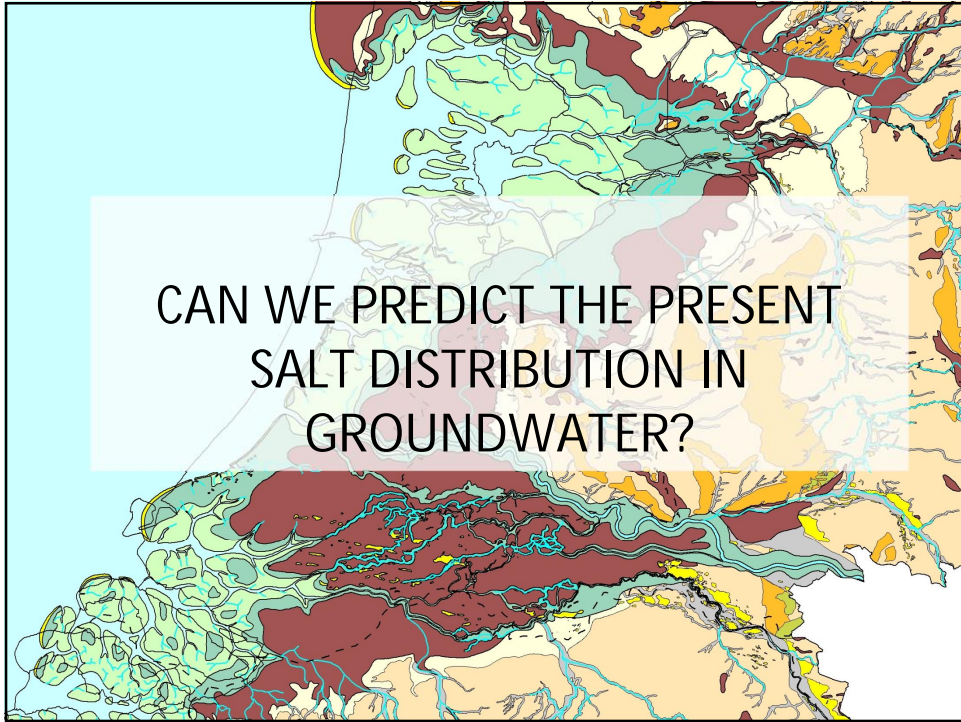

Palaeogeographical development

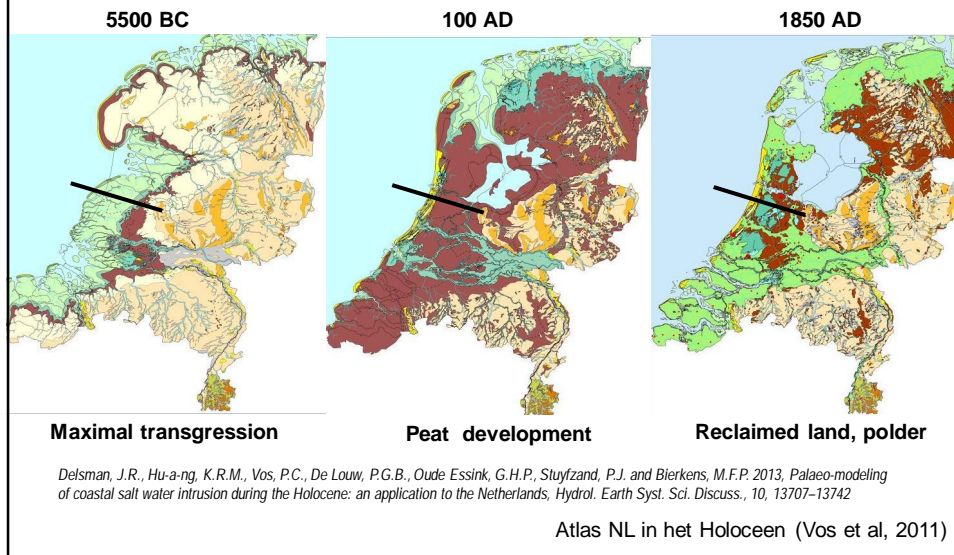

Occurrence of salt under the polder Haarlemmermeer

- Model profile Zandvoort - Hoofddorp – Hilversum
- Palaeogeographical development (Vos et al, 2011)
- 6500 BC - 2010 AD
- marine transgression
- Peat development, peat degradation, drainage, reclamation

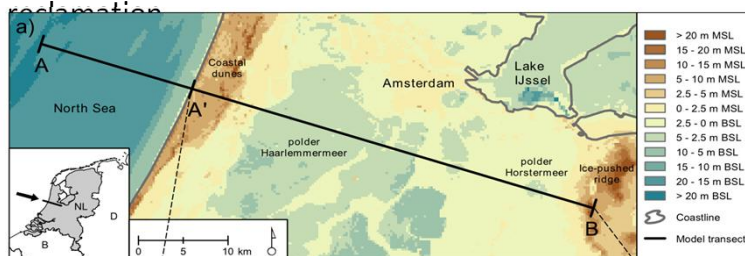

Delsman et al., HESS, 2013

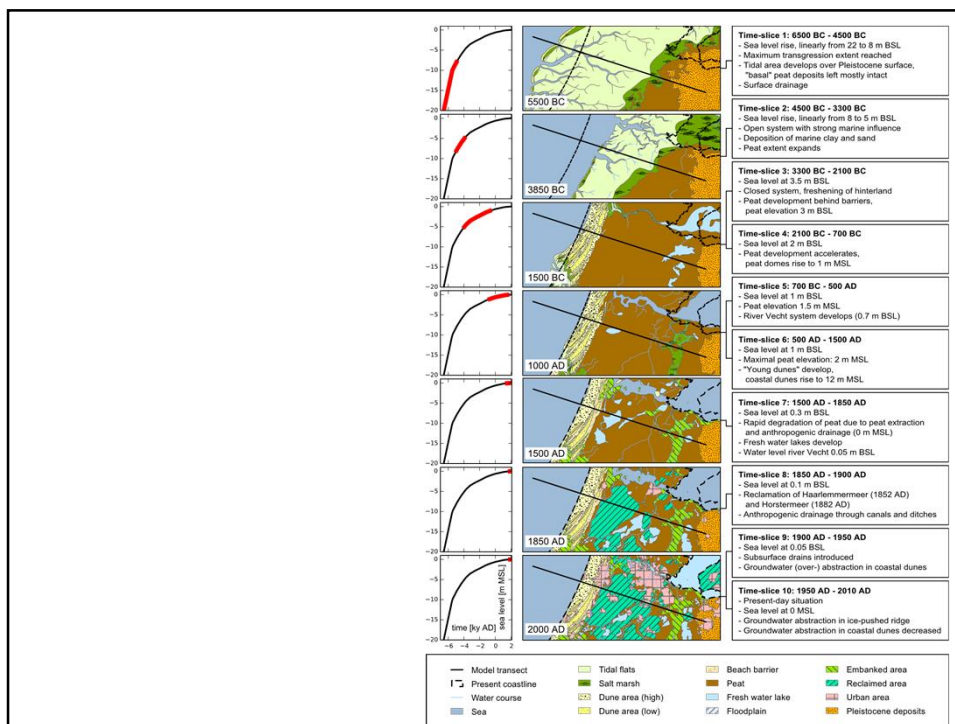
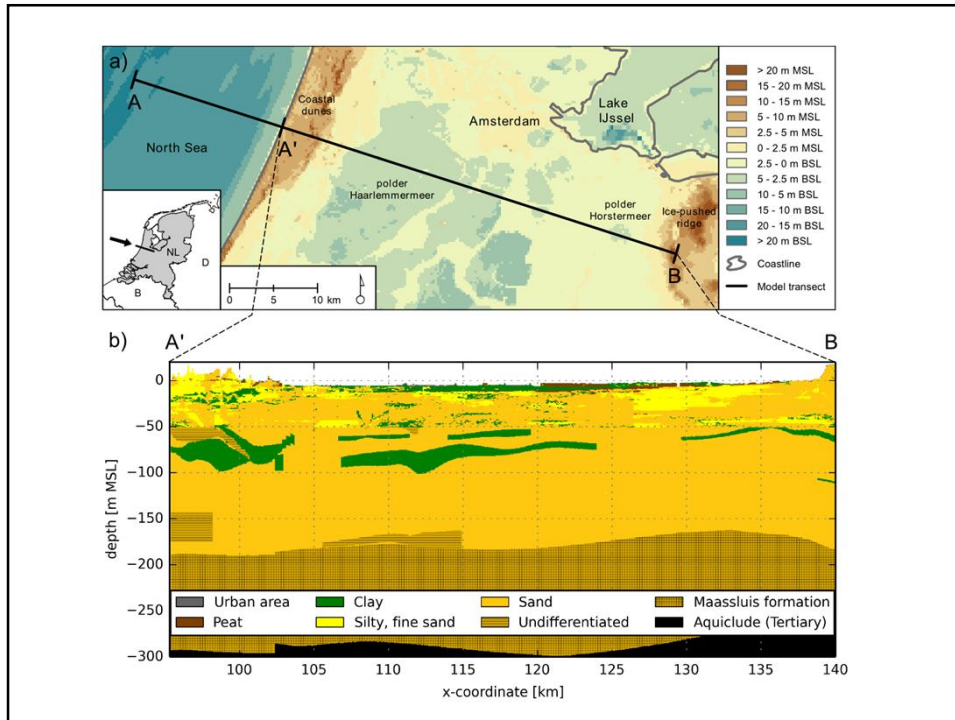

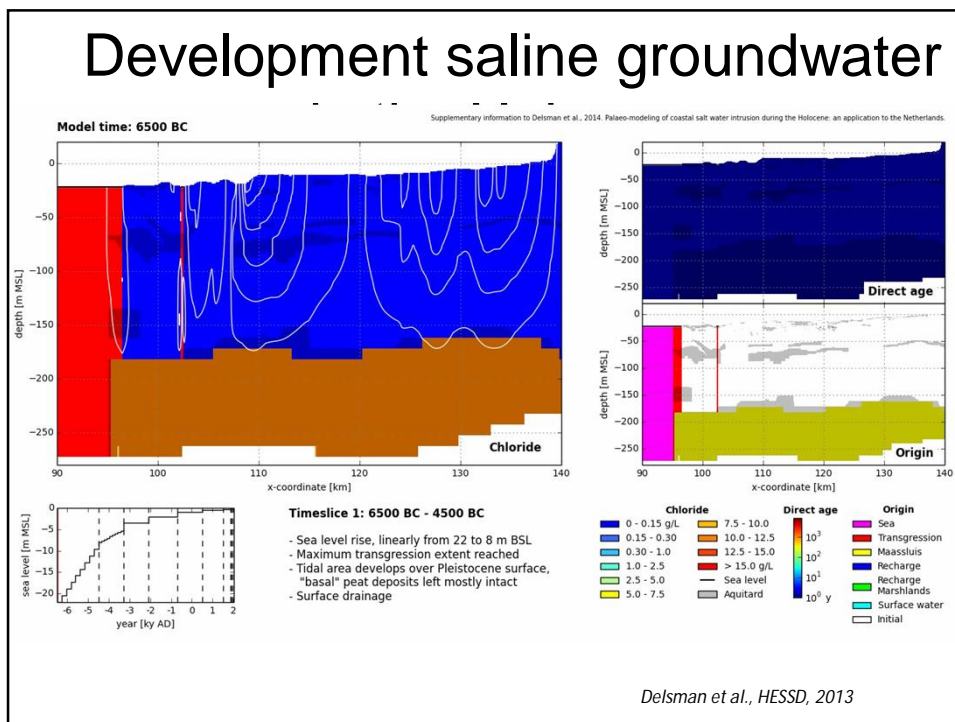
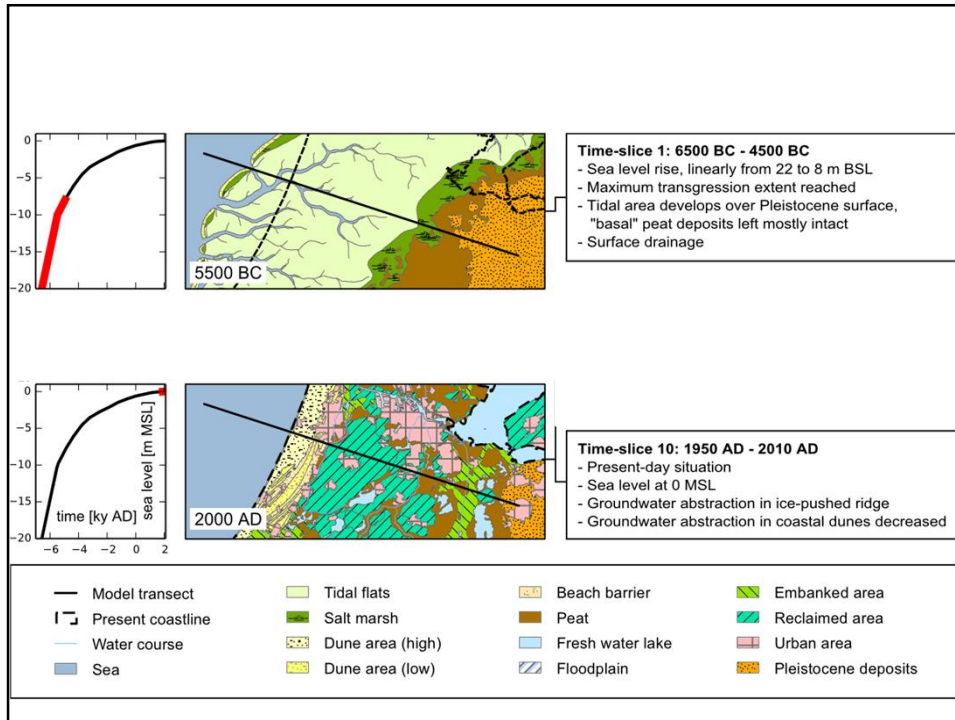

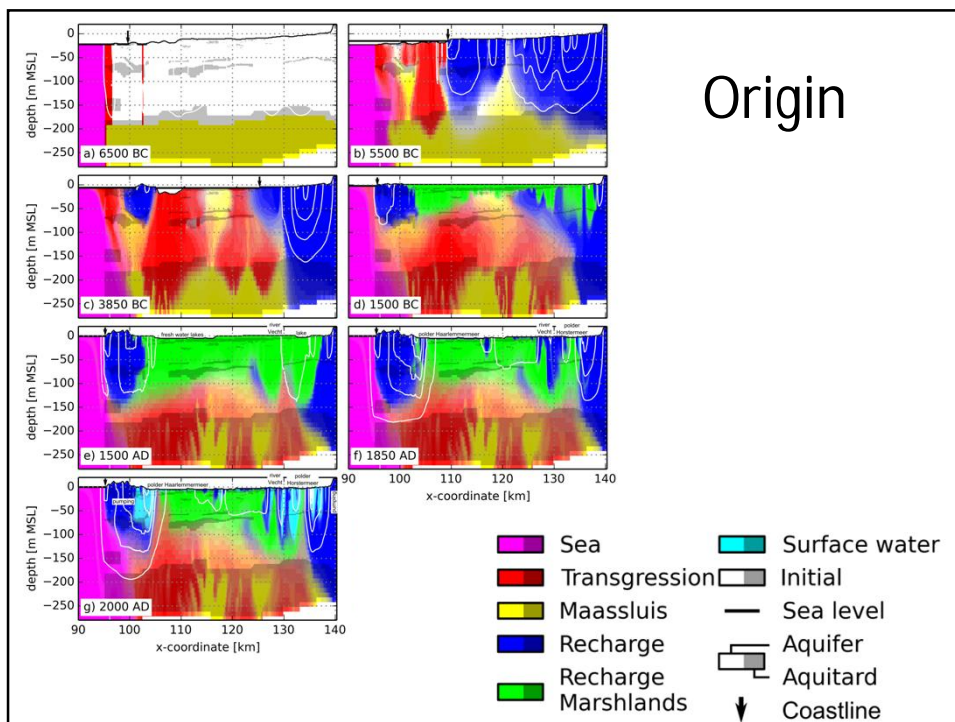
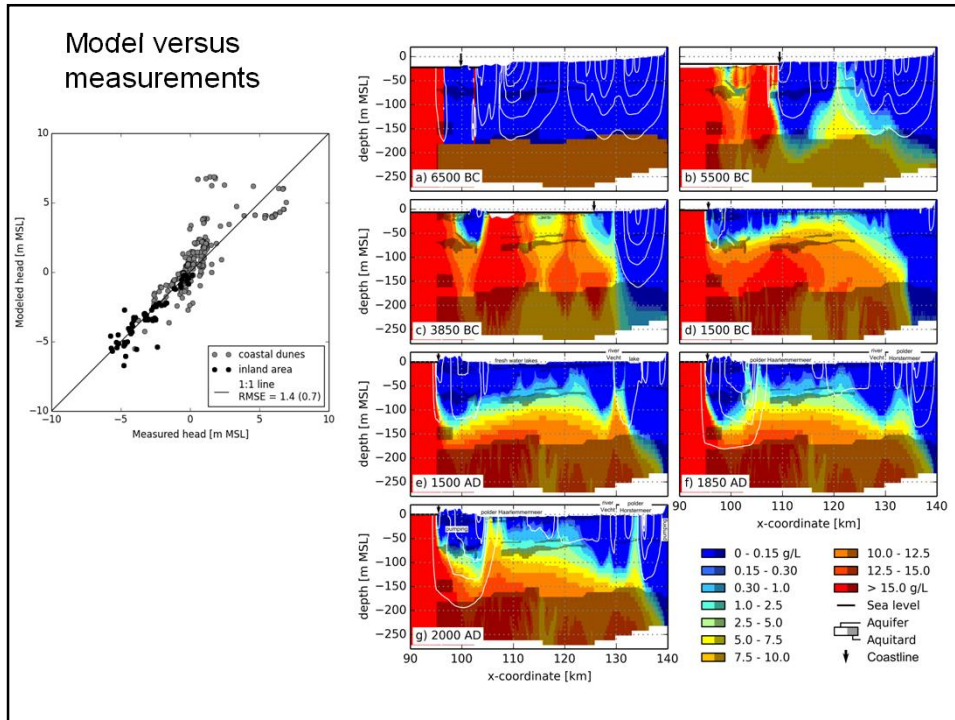

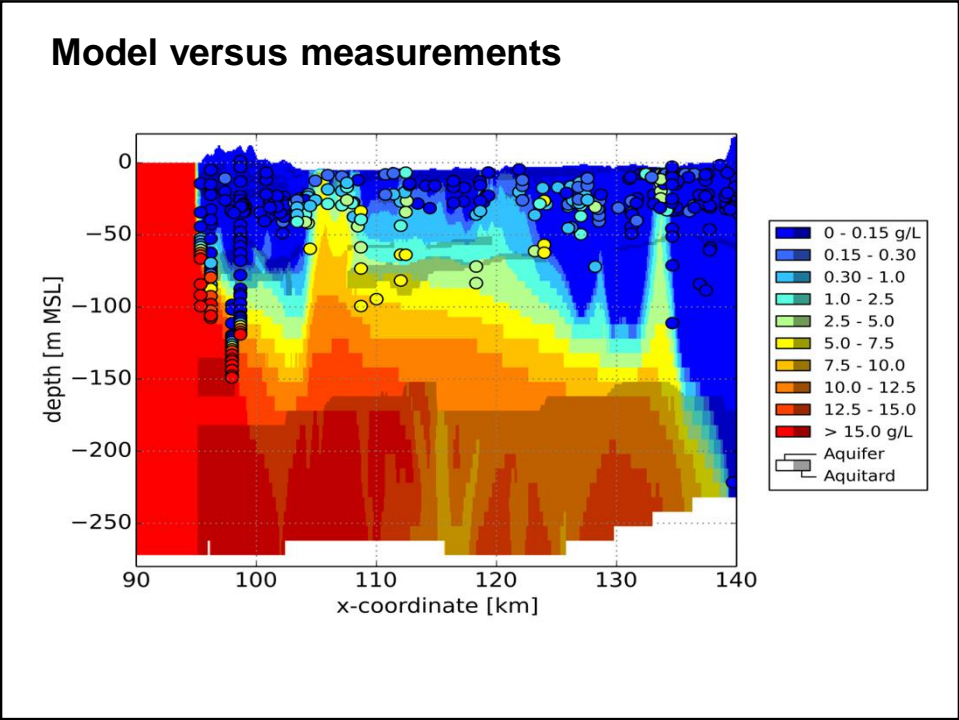
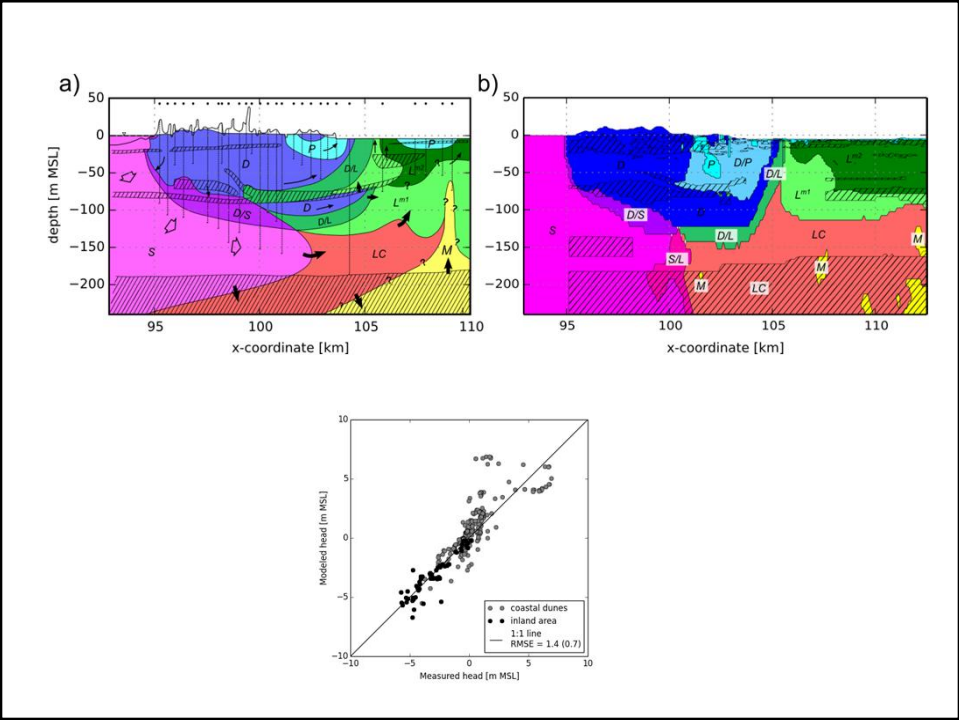

Sharp interface between fresh and saline groundwater

Introduction

Badon Ghyben-Herzberg principle

Difference between reality and Badon Ghyben-Herzberg approximation

concept: mixing zone in reality

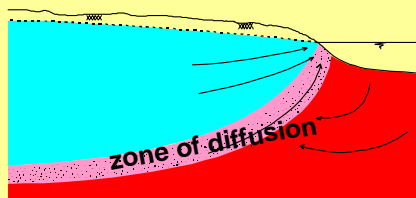

concept: interface between fresh and saline groundwater

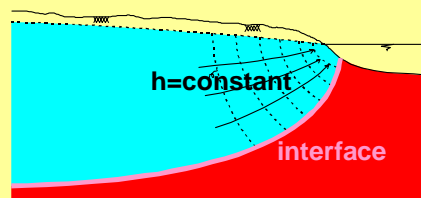

Badon Ghijben-Herzberg principle

The principle suggests an interface between fresh and saline groundwater

Analogy: iceberg & saline ocean and granite tectonic plate & basalt base

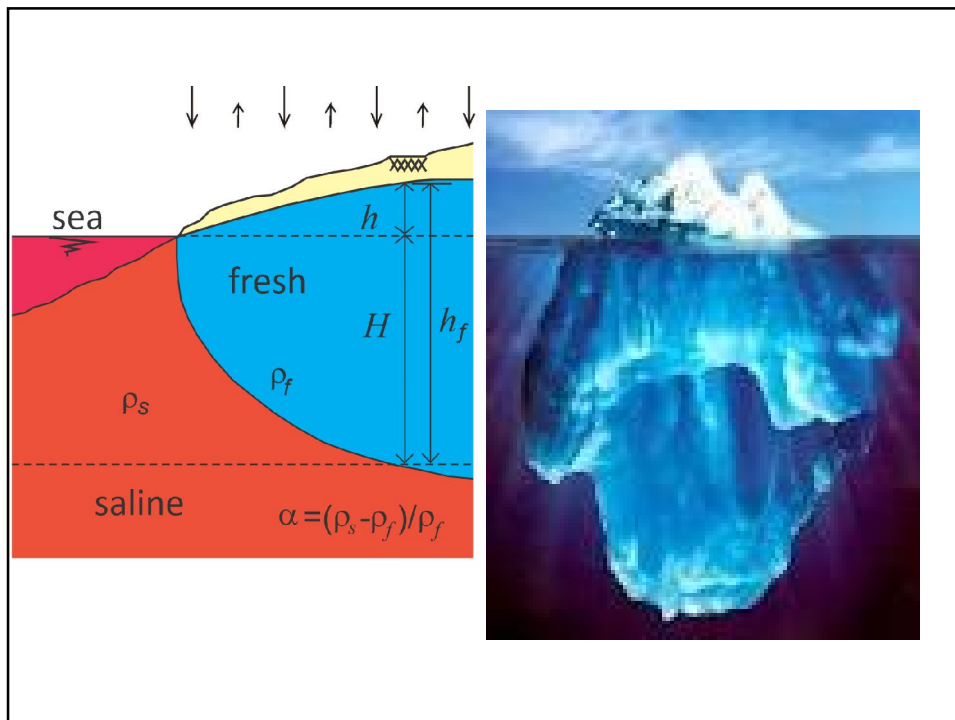
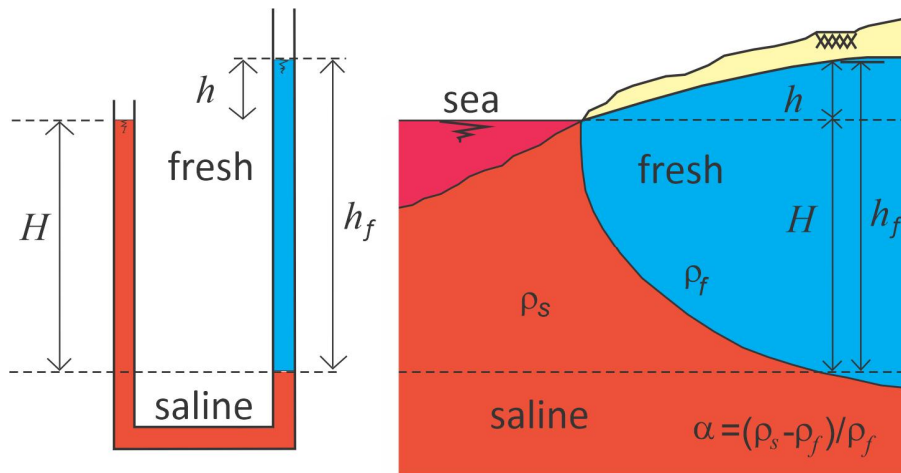

pressure saline groundwater = pressure fresh groundwater

$$\rho_s H g = \rho_f (H + h) g$$

$$h = \frac{\rho_s - \rho_f}{\rho_f} H$$

$$h = \alpha H$$

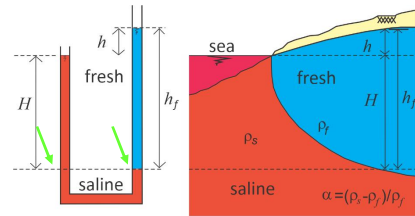

$$h = \alpha H \quad h = \frac{\rho_s - \rho_f}{\rho_f} H \quad h = \frac{1025 - 1000}{1000} H$$

$h = \alpha H$
in ocean water $\alpha = 0.025$
 $h = 1 \text{ m}, H = 40 \text{ m}$

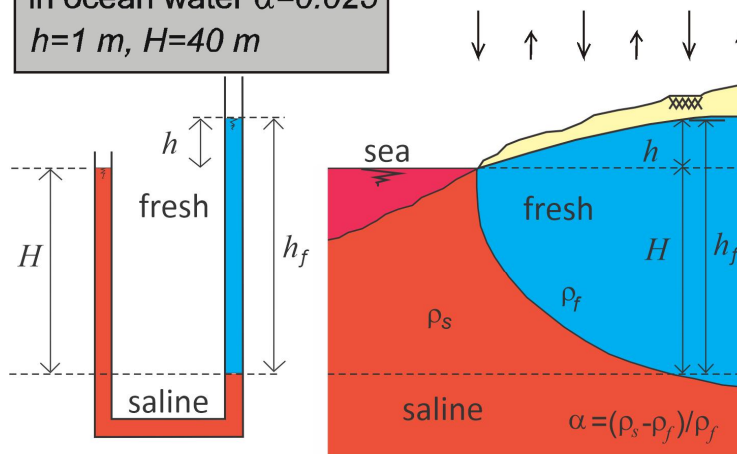

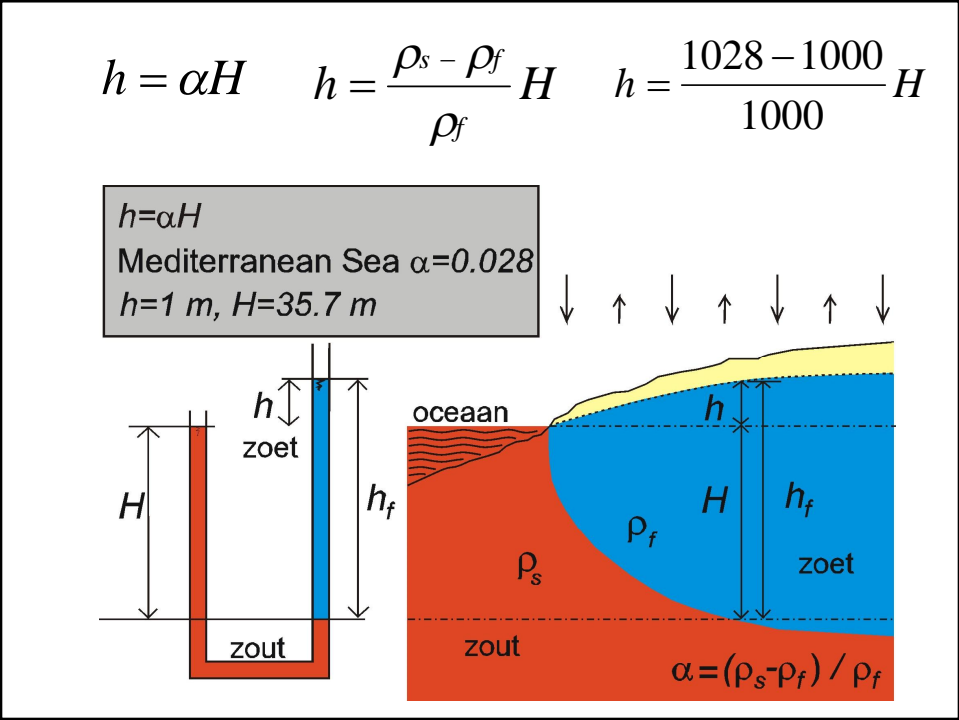

Badon Ghyben-Herzberg principle

- gives analytical solutions (see later and lectures)
- educational

- interface is a simple approximation
- dispersion zone <10m
- relative simple geometries

Badon Ghyben-Herzberg principle

What is the case then $h \neq \alpha H$?

1. still dynamic situation
2. occurrence resistance layer
3. natural groundwater recharge not constant
4. relative density difference α is not ok
5. occurrence shallow bedrock
6. groundwater extractions

Case 1: Vertical interface between fresh and saline groundwater

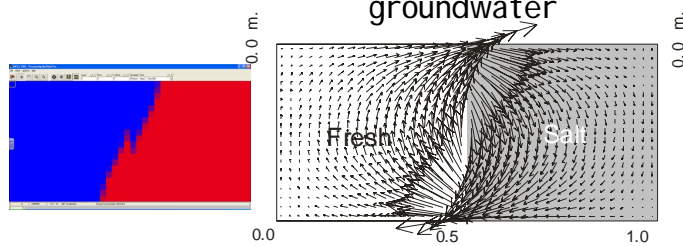

Parameters			
Layers	20	K_{hor}	$1 \cdot 10^{-3}$ m/s
Rows	1	T	$2.5 \cdot 10^{-5}$ m/s
Columns	40	Anisotropy K_{hor}/K_{ver}	1
Δx	0.025 m	n_e	0.1
Δy	1 m	α_L	0 m
Δz	0.025 m	α_T	0 m
Stress periods	15		
Initial concentration	0 and 35000 mg/l		
bouyancy	0.025		

Vertical interface

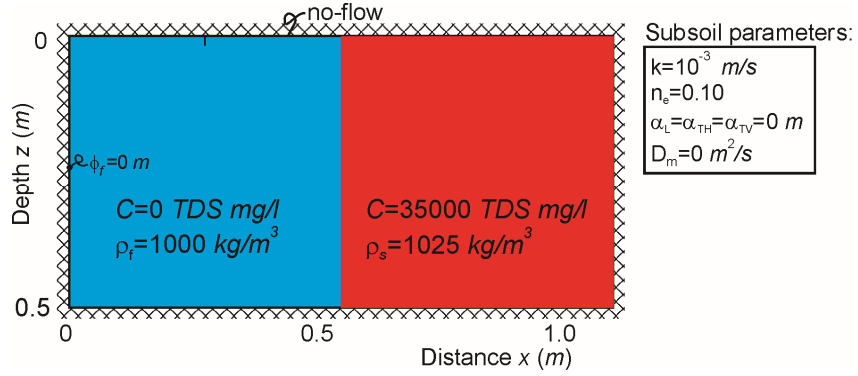

Effect of the number of cells on the shear flow at the interface at t=0

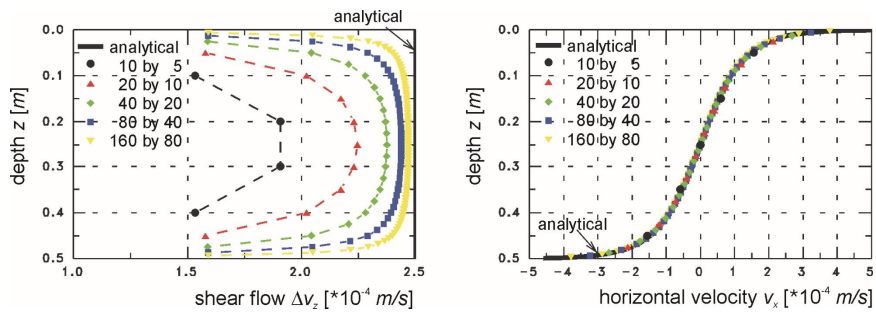

$$\Delta v_z = \frac{k}{n_e} \left(\frac{\rho_s - \rho_f}{\rho_f} \right)$$

$$v_x = \frac{k}{n_e} \left(\frac{\rho_s - \rho_f}{\rho_f} \right) \frac{1}{\pi} \ln \tan \left(\frac{\pi z}{2D} \right)$$

Vertical interface

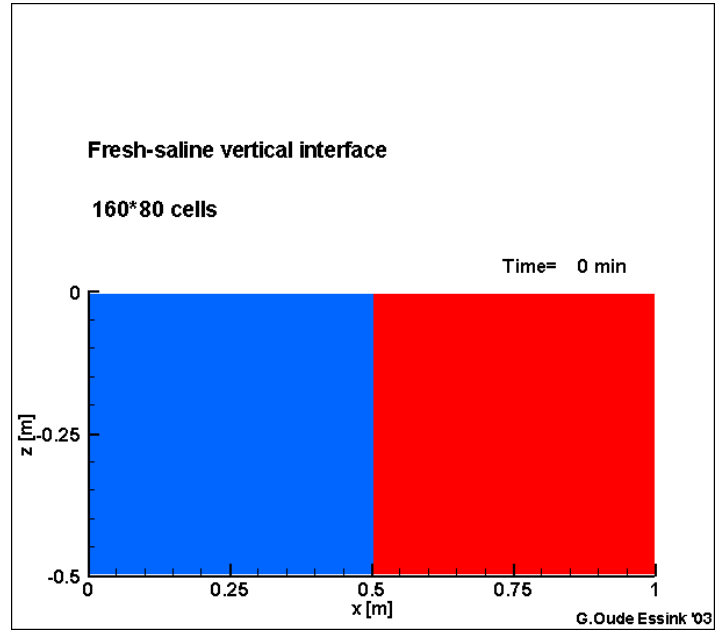

Vertical interface

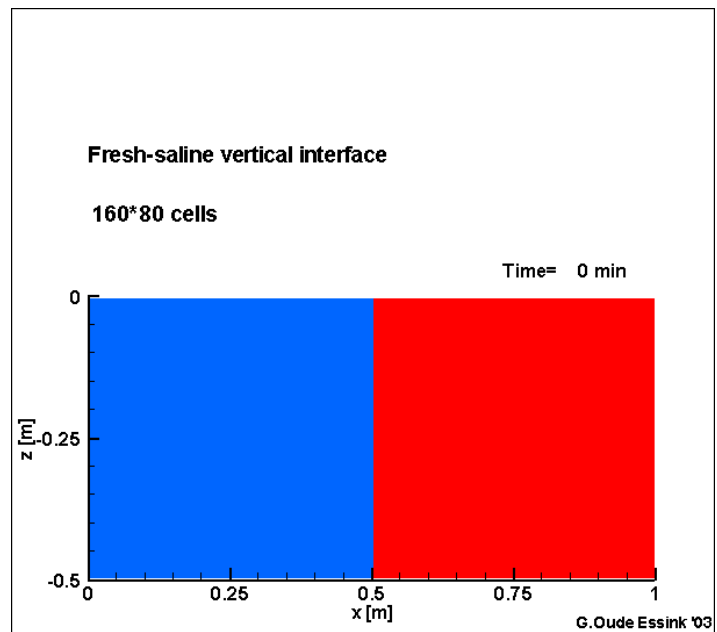

The effect of numerical solvers on the salt transport

Examples

EWRRMP 201511

Default parameters solvers

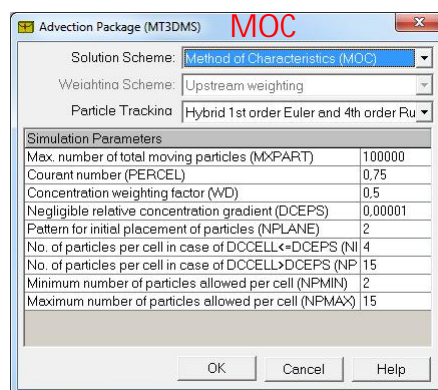
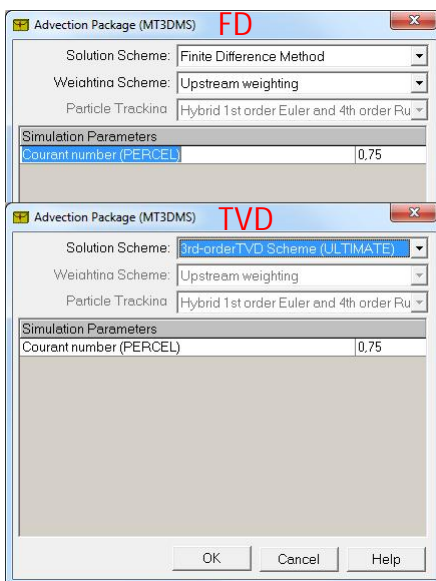

Default parameters solvers

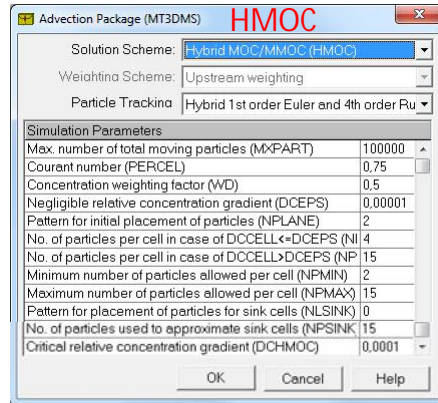
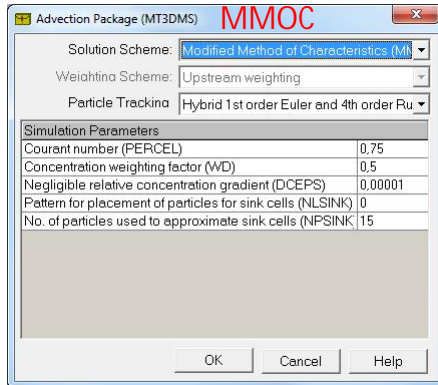

More information:

Zheng, C., & Wang, P. (1999). MT3DMS: A modular three-dimensional multispecies transport model for simulation of advection, dispersion, and chemical reactions of contaminants in groundwater systems. Technical report, Waterways Experiment Station, US Army Corps of Engineers.

1 particle per cell

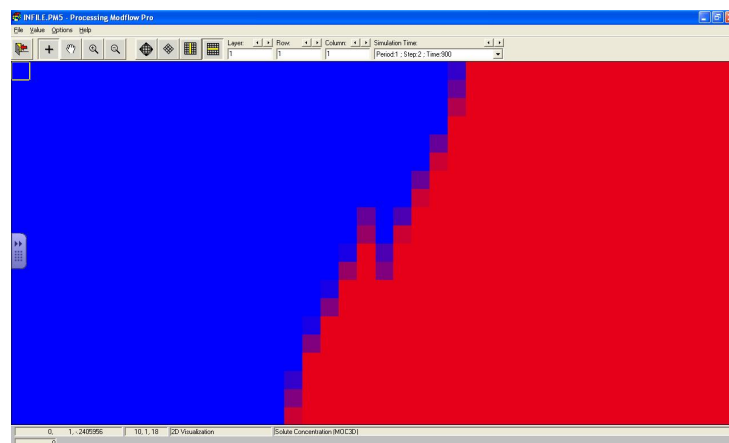

ULTIMATE

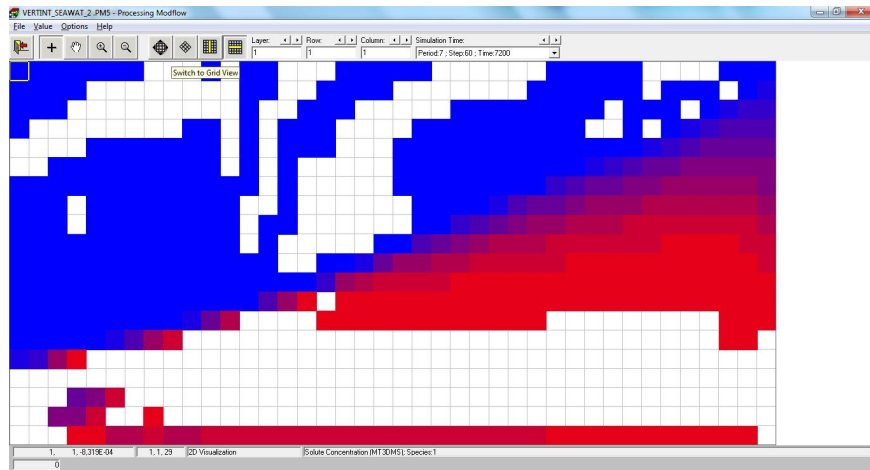

MMOC, NPLANE=0

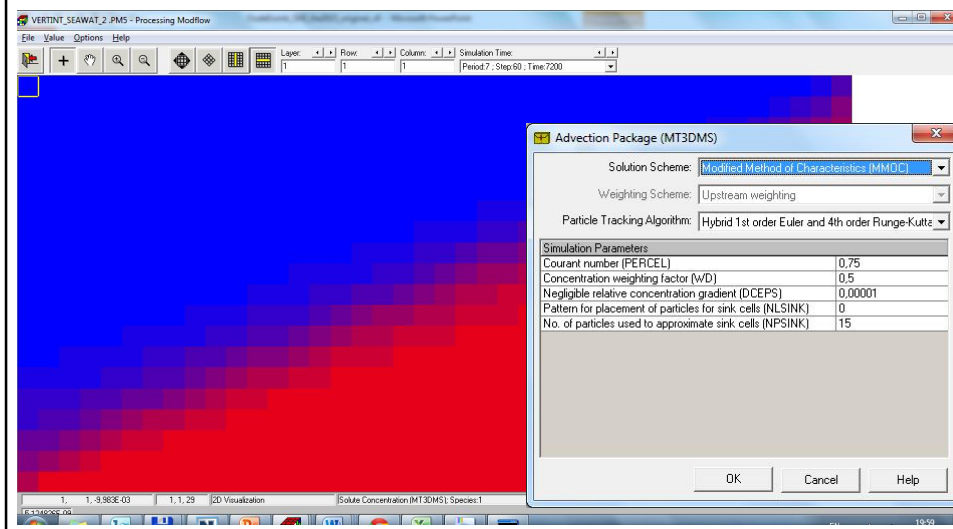

MMOC, NPLANE=10

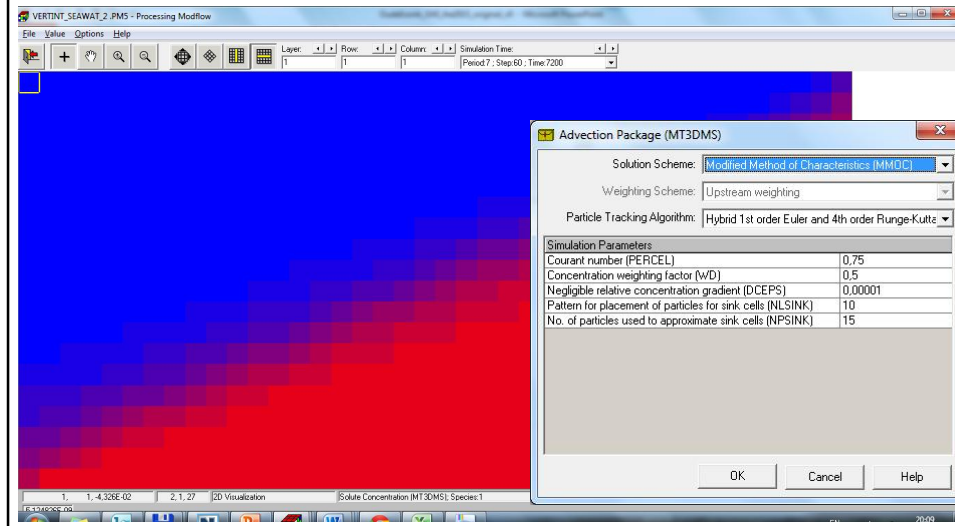

HMOC

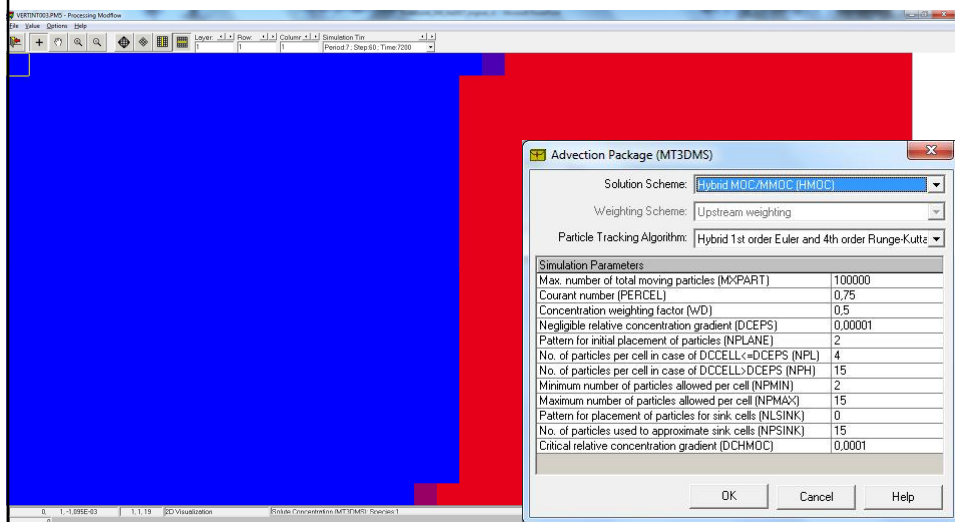

Finite Difference Method

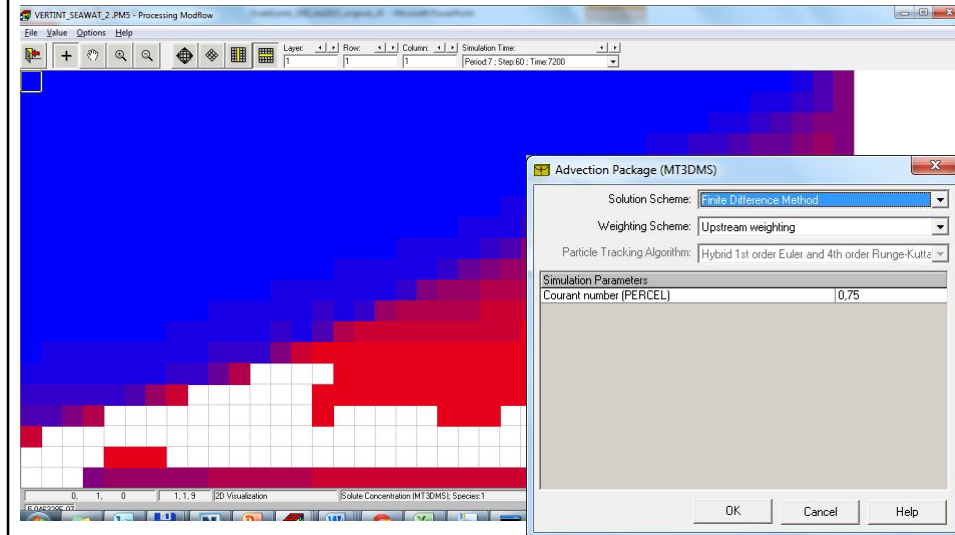

MOC

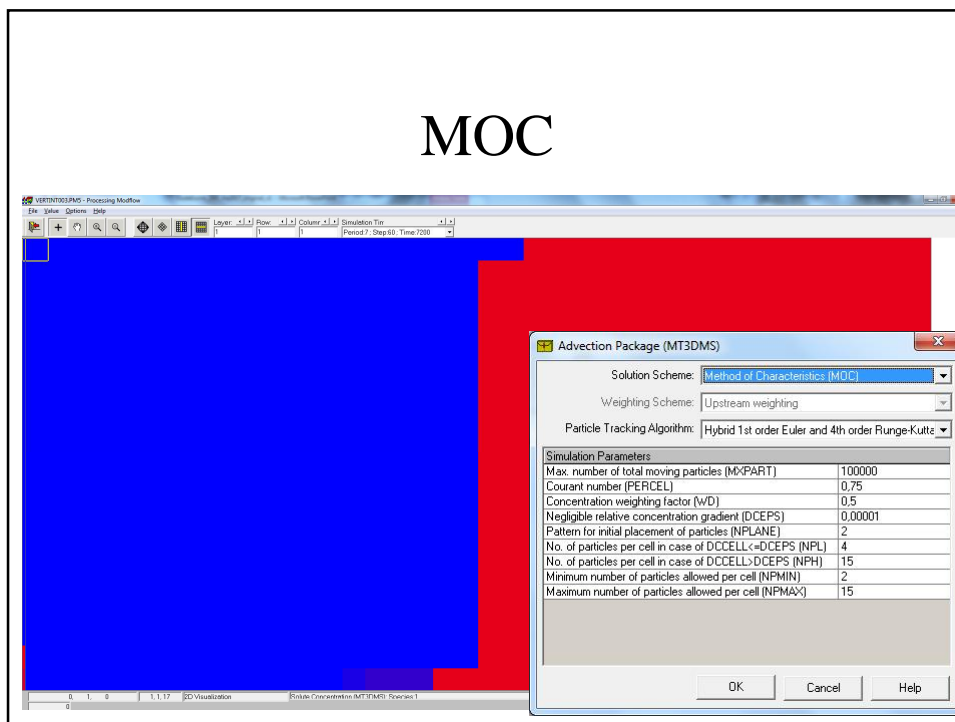

MOC

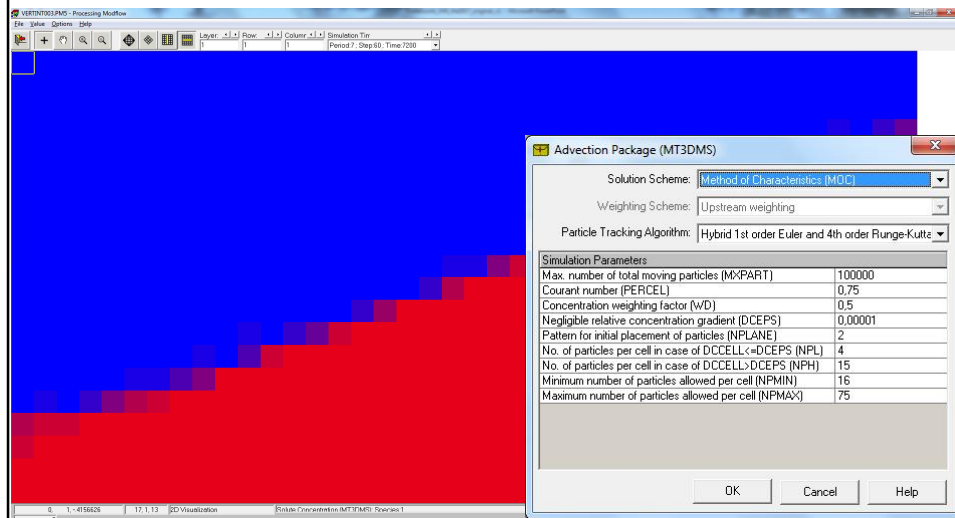

cases

Rotating immiscible interfaces

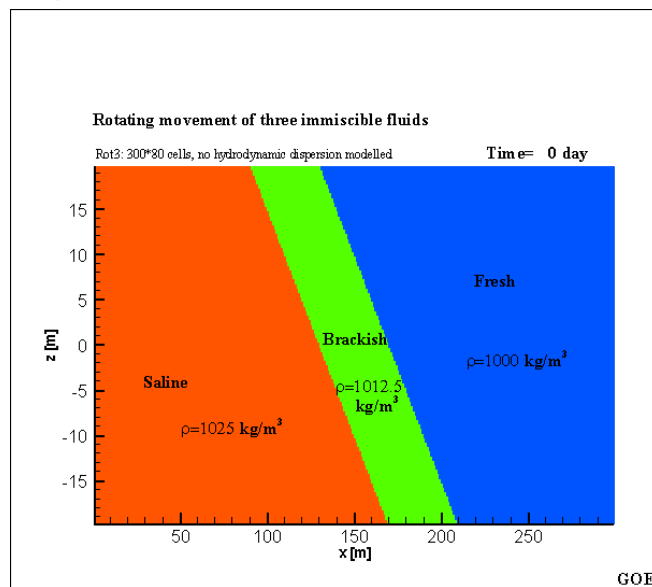

Rotating immiscible interfaces

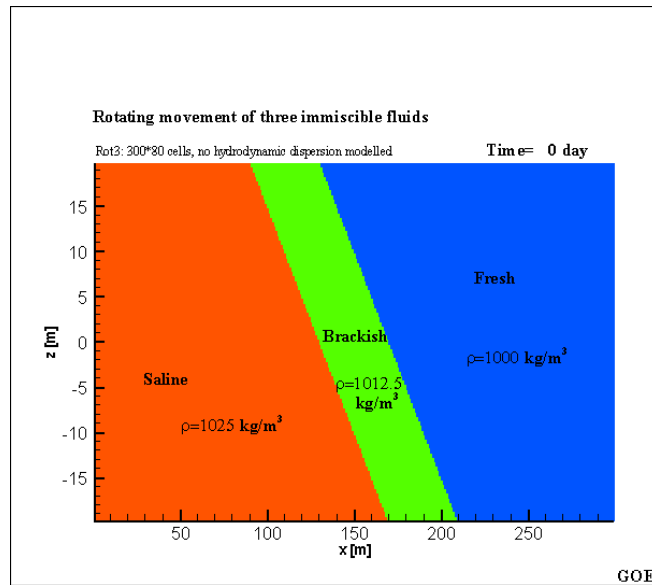

Rotating immiscible interfaces (asymmetric)

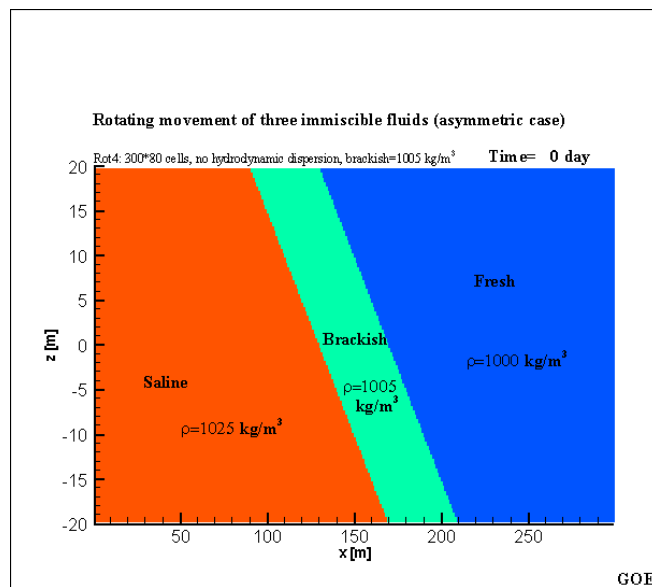

Rotating immiscible interfaces (asymmetric)

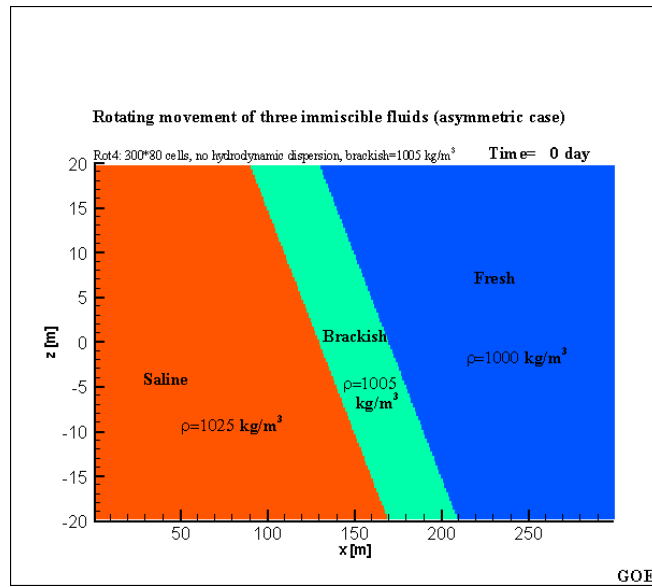

Bakker, M., Oude Essink, G.H.P. & Langevin, C. 2004. The rotating movement of three immiscible fluids, J. of Hydrology 287, 270-278

Rotating interfaces with dispersion $\alpha_L=0.5m$

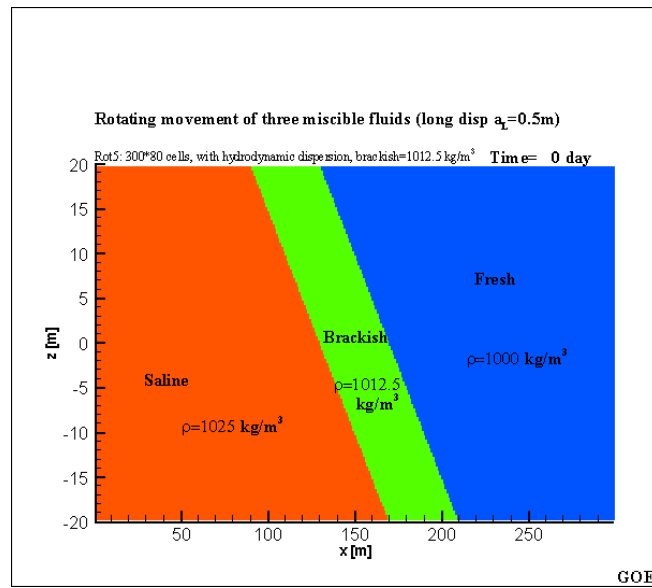

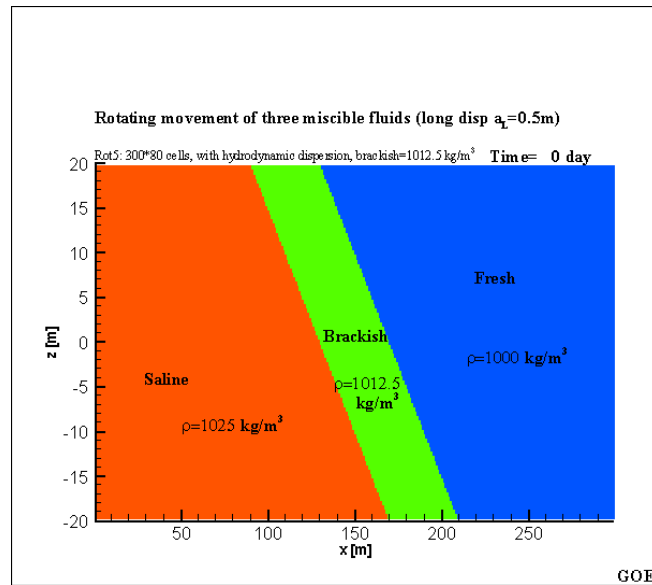
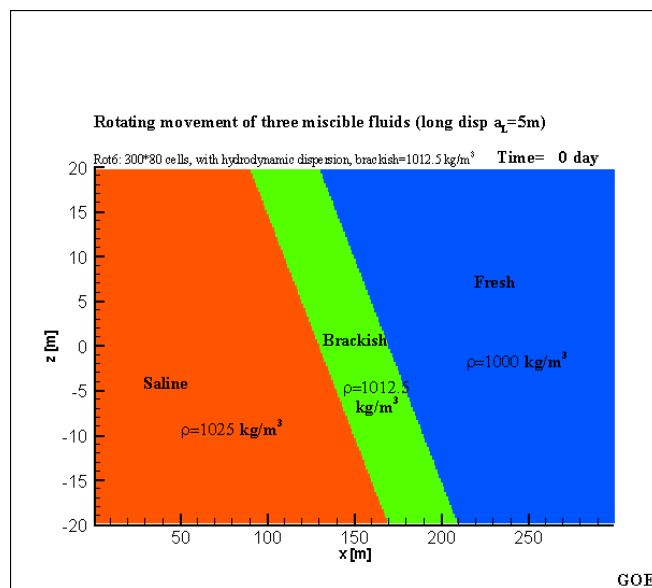
Rotating interfaces with dispersion $\alpha_L=0.5m$ Rotating interfaces with dispersion $\alpha_L=5m$ 

Rotating interfaces with dispersion $\alpha_L=5m$

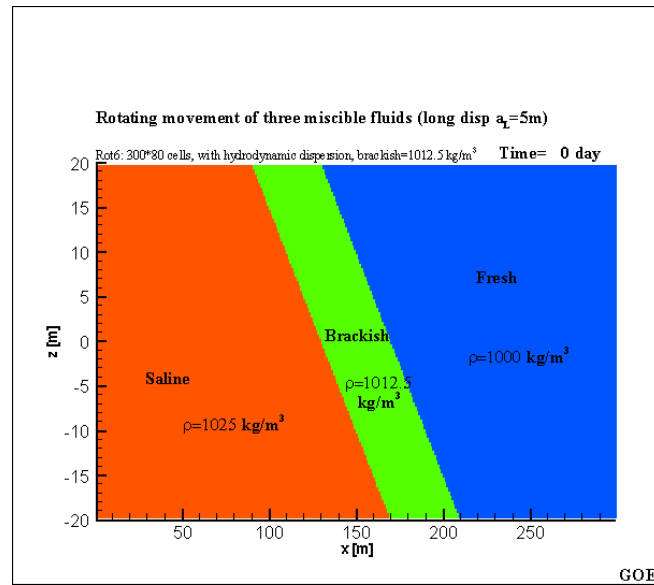

Rotating immiscible interfaces

Conclusion:

To check the variable-density component of your code, this immiscible interface benchmark can be used.

Evolution of a freshwater lens

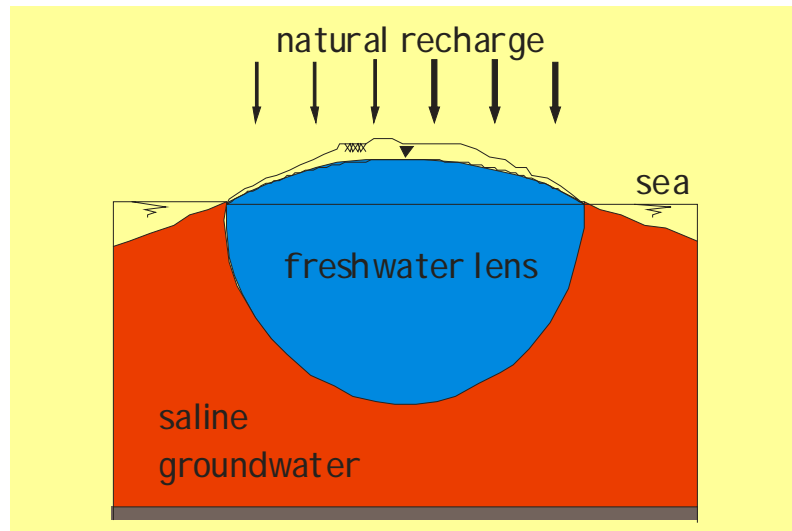

cases

Question:

How long does it take before the volume of a freshwater lens is filled?:

- a. 5 years
- b. 25 years
- c. 100 years
- d. 500 years

T = specific time scale

T = time period before the lens has reached 95% of its final form

In the Netherlands: T = 75-200 jaar,

depends on:

- width dune area
- natural groundwater recharge
- hydraulic conductivity soil

Concept: evolution freshwater lens (not Griend!)

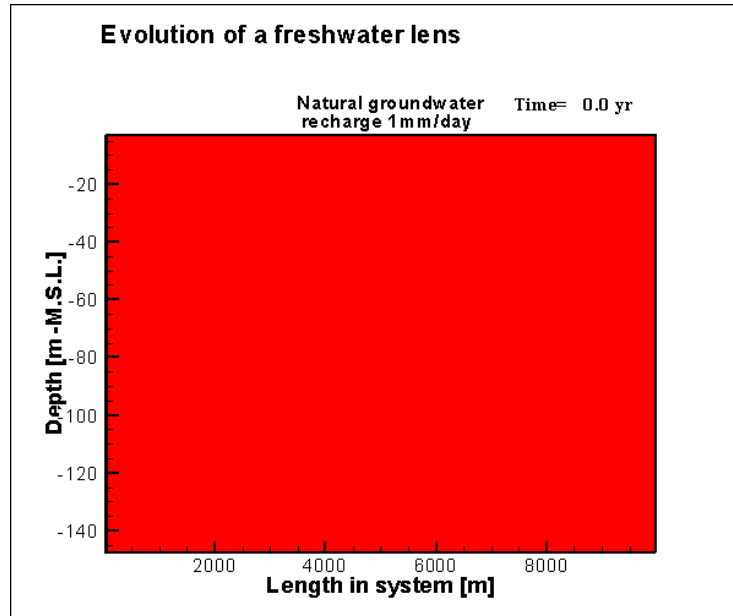

Concept: evolution freshwater lens (not Griend!)

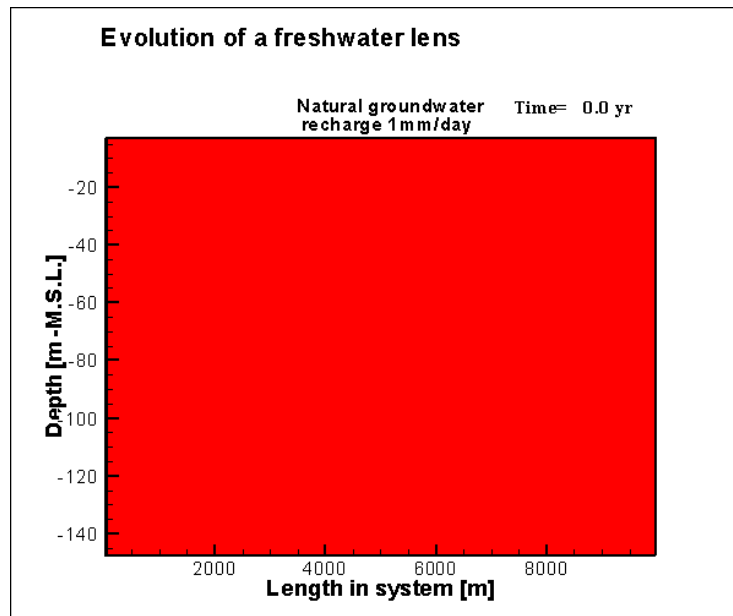

Evolution freshwater lens

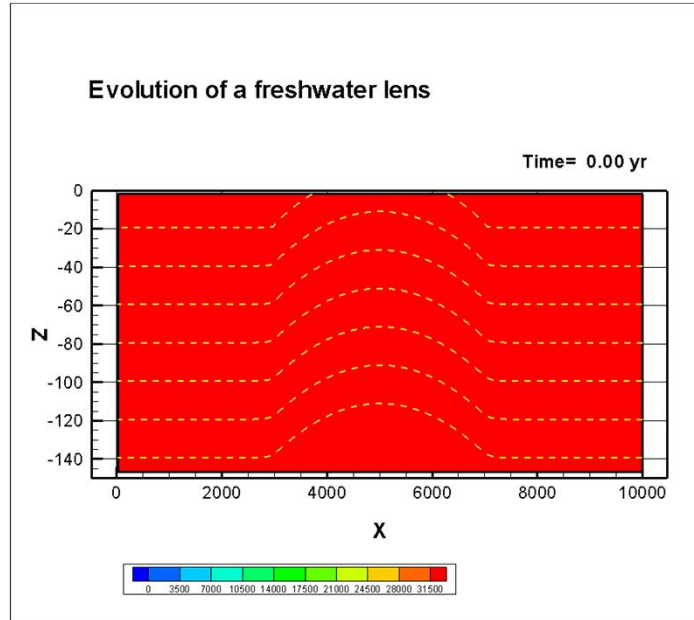

Evolution freshwater lens: no density effects

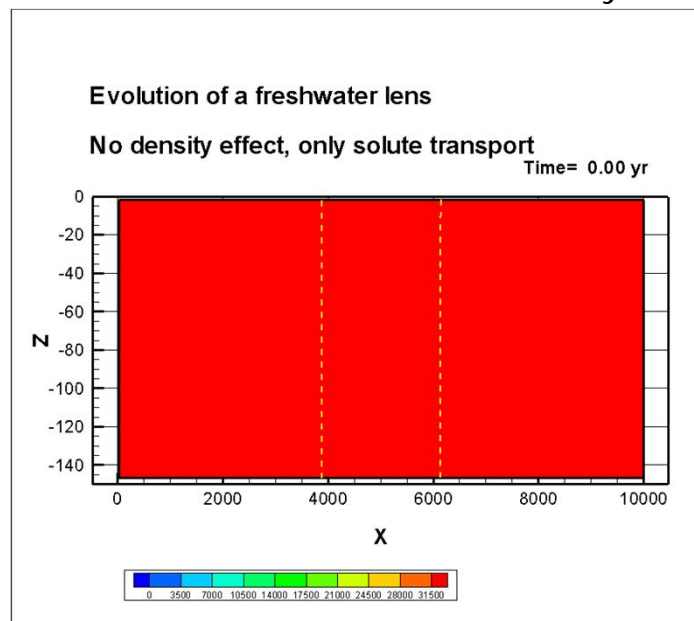

Case 2: Development of a freshwater lens

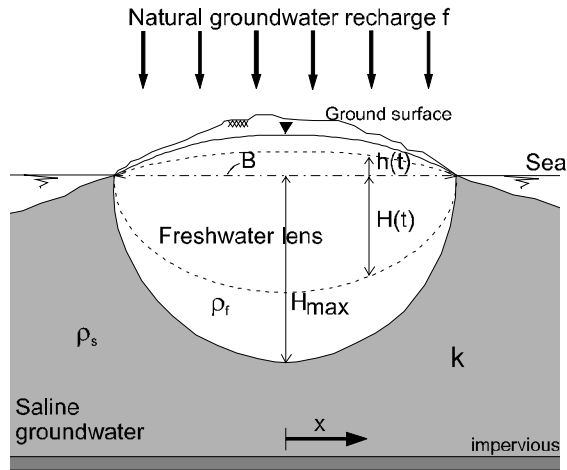

Evolution lens

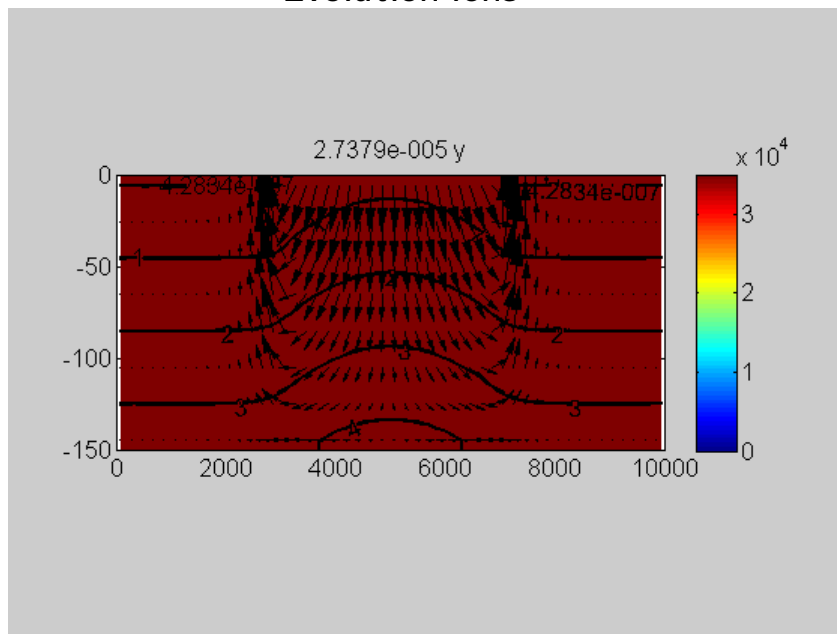

Evolution freshwater head

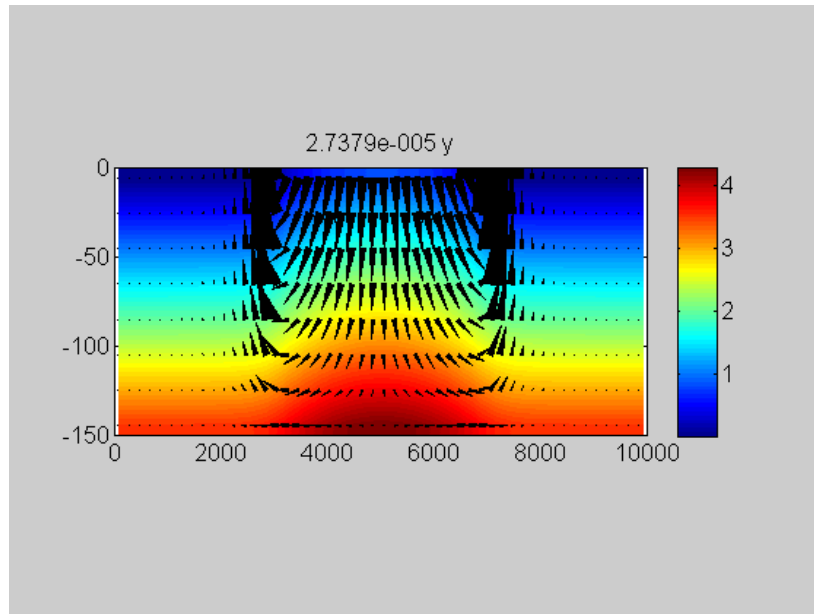

The island of Griend

Issues:

1. Small island moves ~7.5m per year to the east
2. Effect on the volume of the freshwater lens:
 - Can a lens be developed?
 - What is the thickness of the lens?

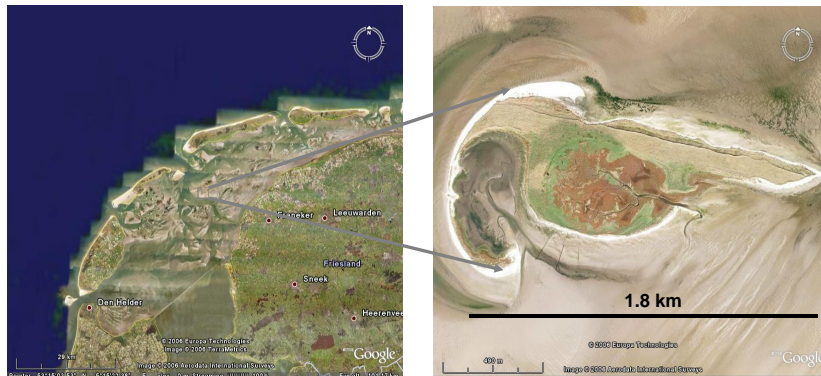

Movement of De Griend and creation of the lens

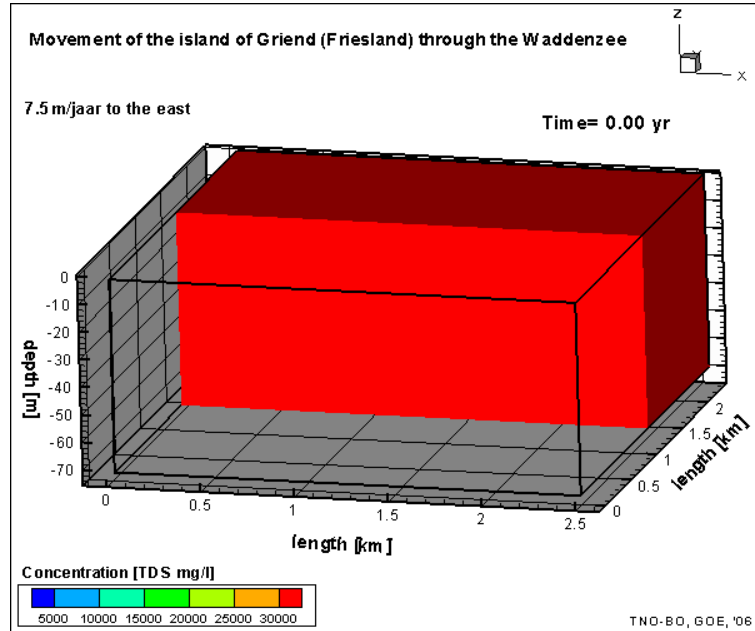

Movement of De Griend and creation of the lens

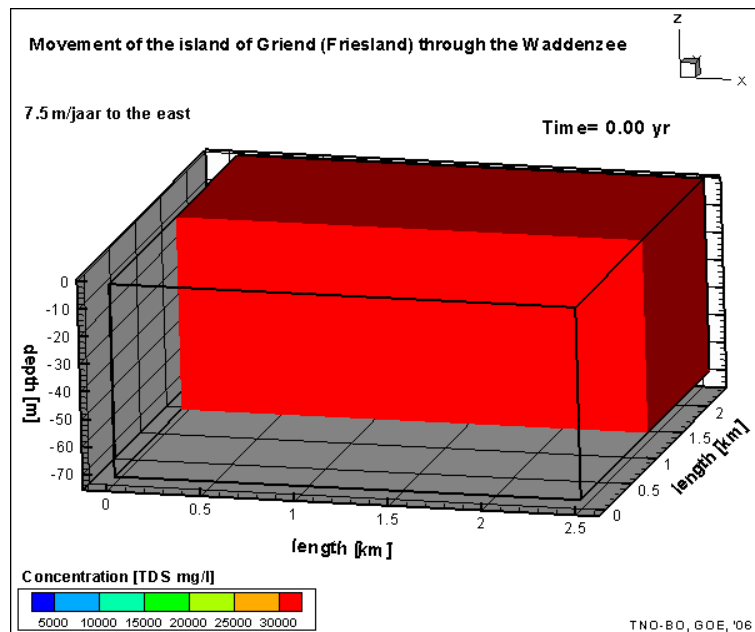

Case 2: Development of a freshwater lens

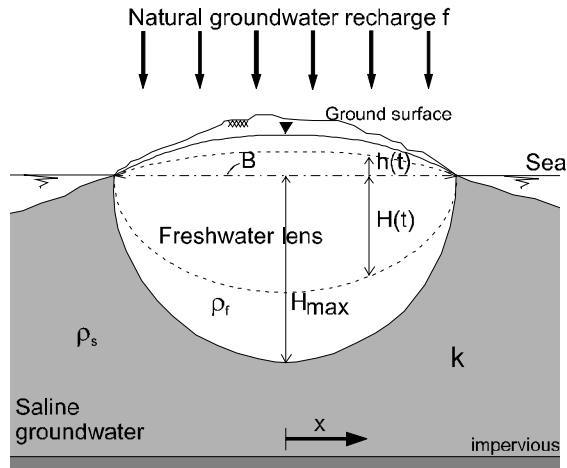

Case 2: Development of a freshwater lens

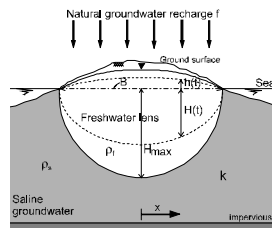

Parameters			
Layers	15	K_{hor}	20 m/d
Rows	1	T	200 m/d
Columns	100	Anisotropy K_{hor}/K_{ver}	10
Δx	100 m	ne	0.35
Δy	10 m	αL	0 m
Δz	10 m	αT	0 m
Stress periods	10	recharge	360 mm/y
Initial concentration	35000 mg/l	Recharge concentration	0 mg/l
bouyancy	0.025		

MOCDENS3D, no disp, 16part

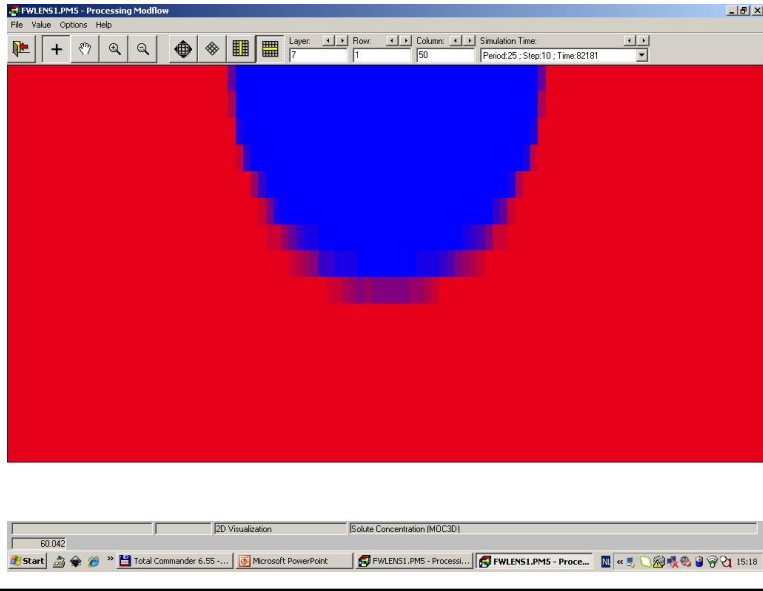

MOCDENS3D, no disp, 4part

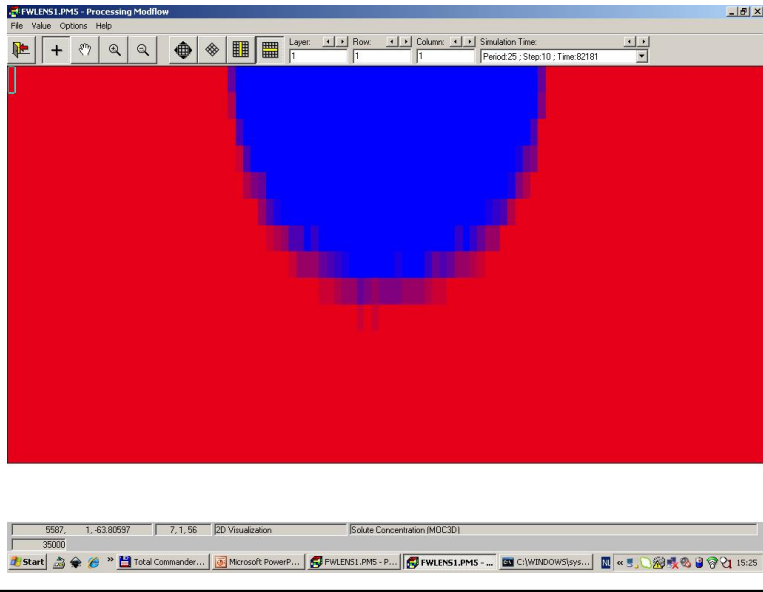

MOCDENS3D, no disp, 1part

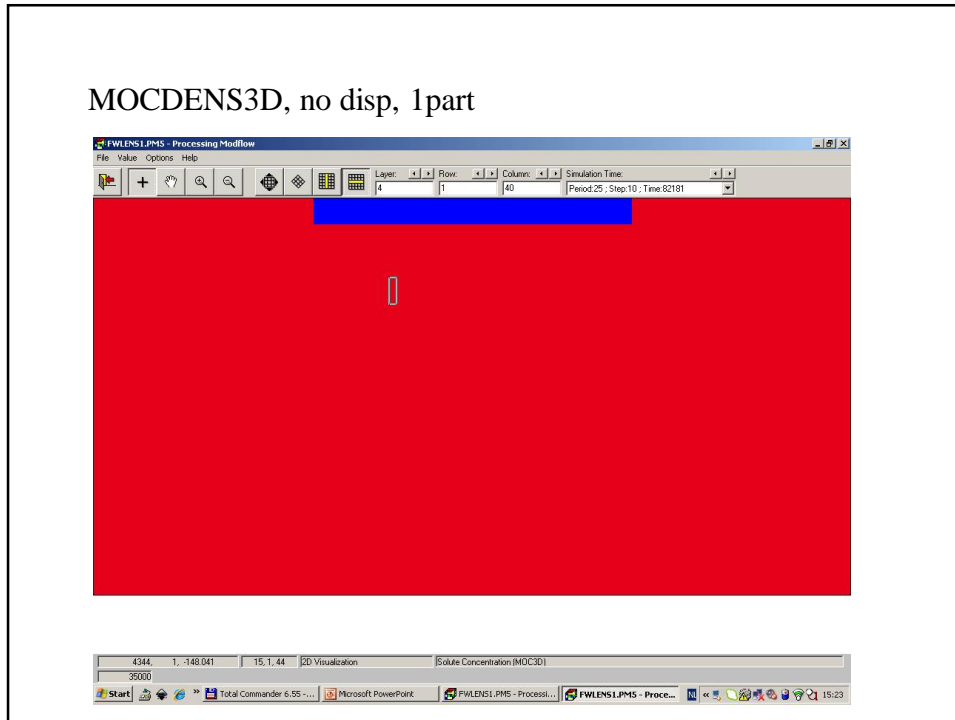

SEAWAT, MOC, NPLANE=2

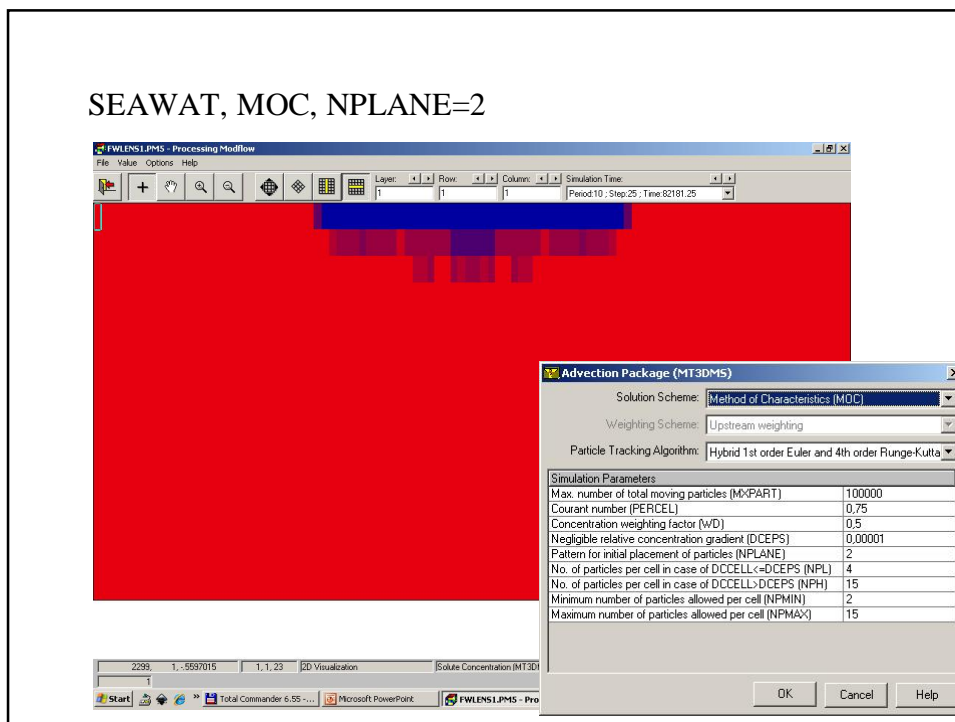

SEAWAT, MOC, 4.NPLANE=16

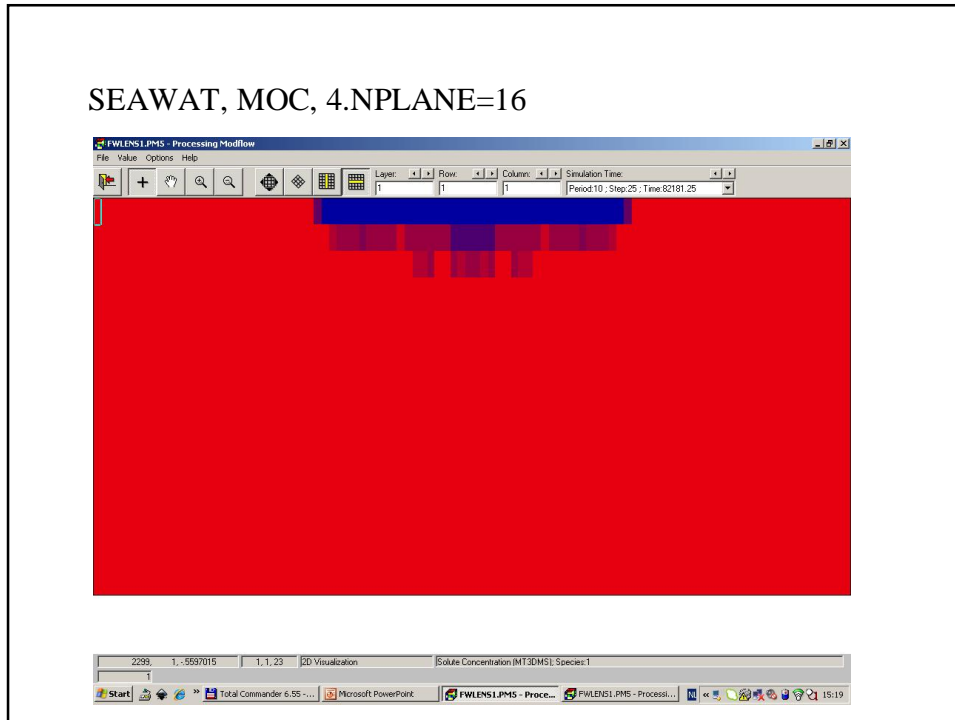

SEAWAT, MOC, 20sec, NPLANE=16, etc.

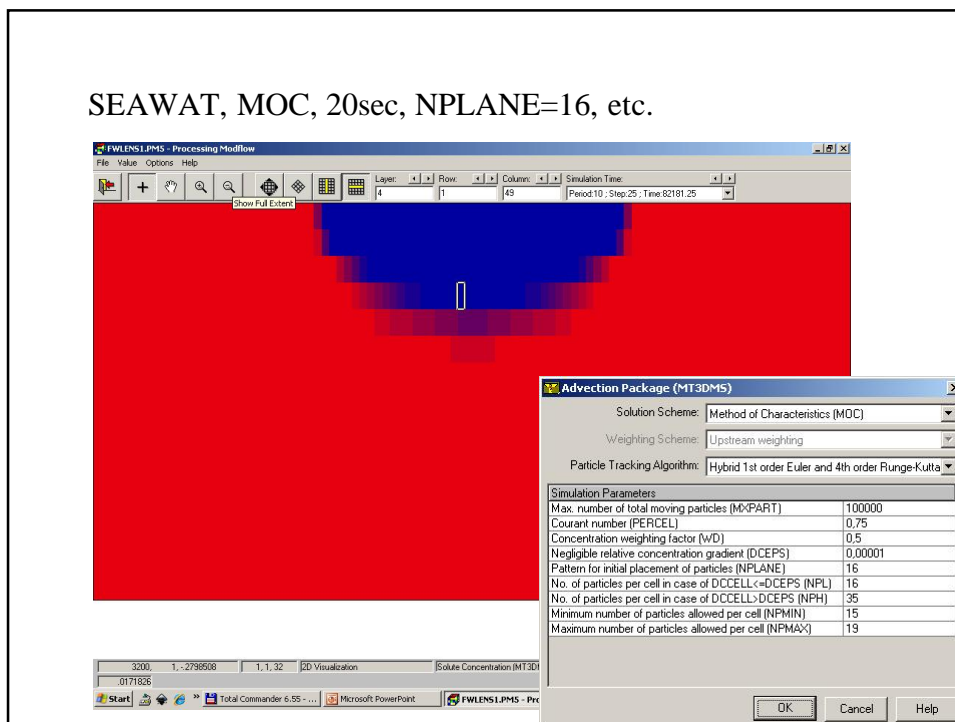

SEAWAT, ULTIMATE, 16.56sec

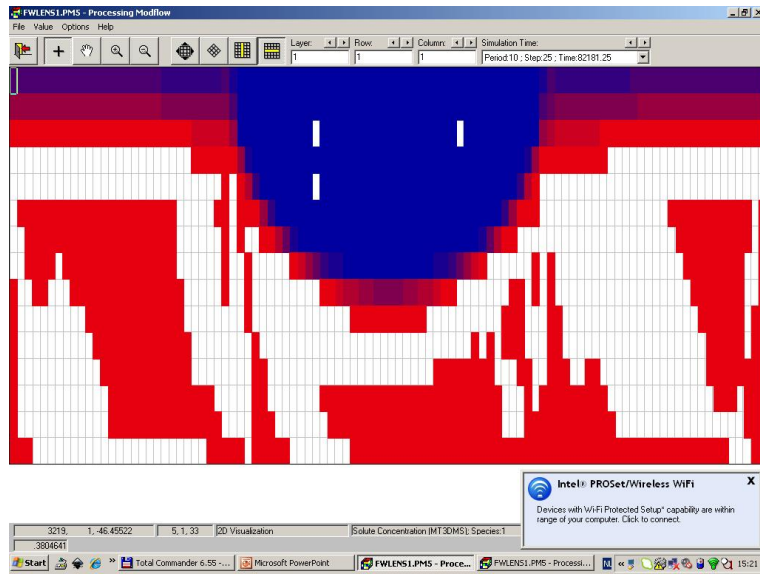

SEAWAT, MMOC, 8.5sec

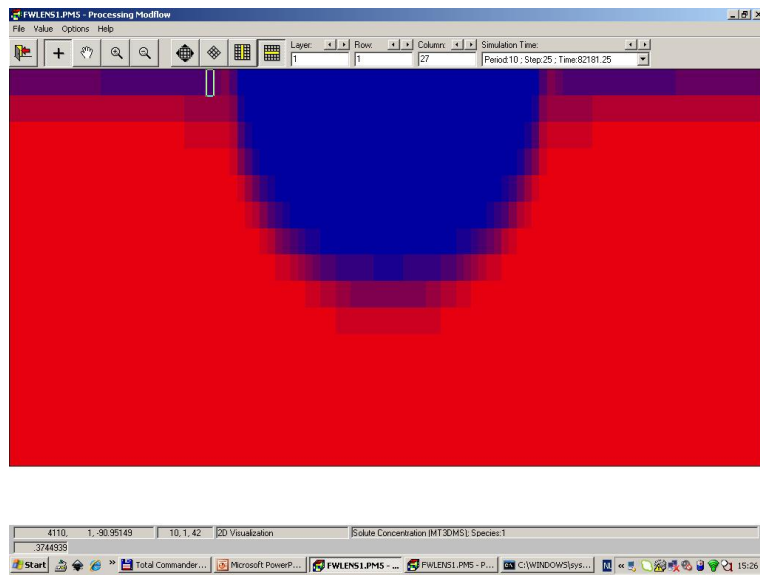

SEAWAT, HMOC, 6.8sec

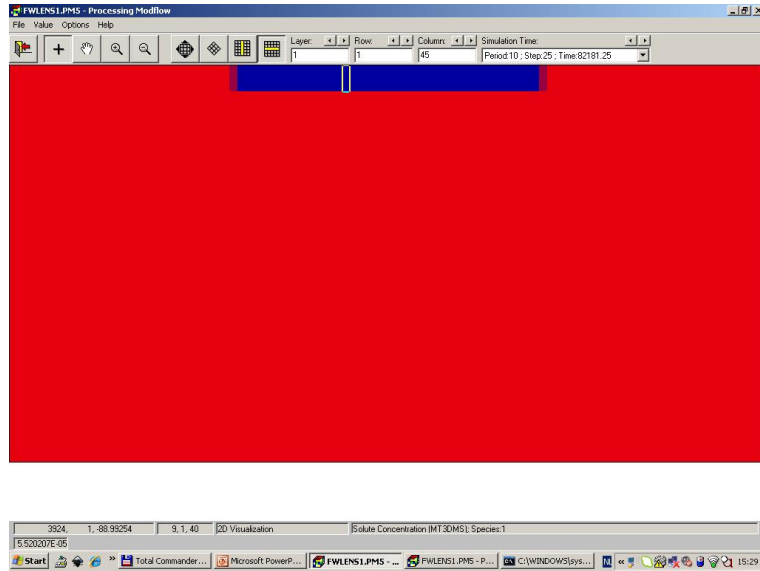

Analytical solutions

Analytical solutions

See lecture notes *Density dependent groundwater flow* (p. 29-48)

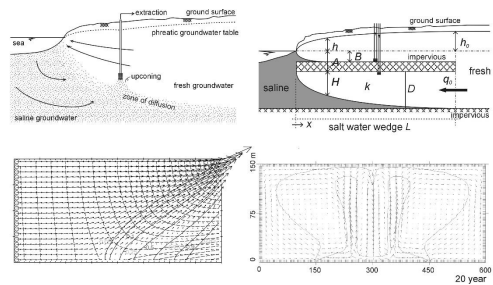

<http://public.deltares.nl/display/FRESHSALT/Download>

Unconfined aquifer (1D situation)

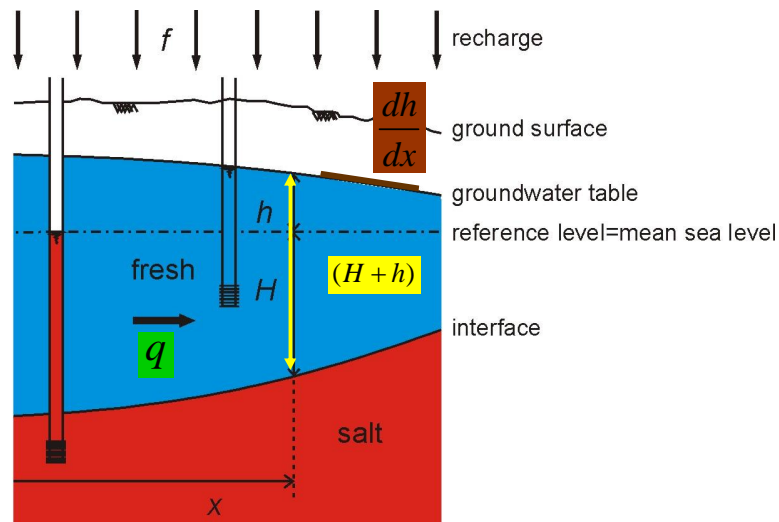

Unconfined aquifer (1D situation)

(I) Darcy $q = -k(H + h)\frac{dh}{dx}$

(II) Continuity $dq = f dx$

(III) BGH $h = \alpha H$

Unconfined aquifer (1D situation)

$$dq = f dx \quad \begin{array}{l} \text{integration} \\ \text{gives} \end{array} \quad q = fx + C1$$

$$-k(H + h)\frac{dh}{dx} = fx + C1$$

$$h = \alpha H \rightarrow -k(H + \alpha H)\alpha \frac{dH}{dx} = fx + C1$$

$$H dH = -\frac{fx + C1}{k\alpha(1 + \alpha)} dx$$

Unconfined aquifer (1D situation)

$$HdH = -\frac{fx + C1}{k\alpha(1+\alpha)} dx$$

integration
gives

$$\frac{1}{2}H^2 = \frac{-\frac{1}{2}fx^2 - C1x + C2}{k\alpha(1+\alpha)}$$

$$H = \sqrt{\frac{-fx^2 - 2C1x + 2C2}{k\alpha(1+\alpha)}}$$

Unconfined aquifer (1D situation)

$$H = \sqrt{\frac{-fx^2 - 2C1x + 2C2}{k\alpha(1+\alpha)}}$$

$$h = \alpha H$$

$$q = fx + C1$$

Example 1: Elongated island

$$H = \sqrt{\frac{-fx^2 - 2C_1x + 2C_2}{k\alpha(1+\alpha)}} \quad q = fx + C_1$$

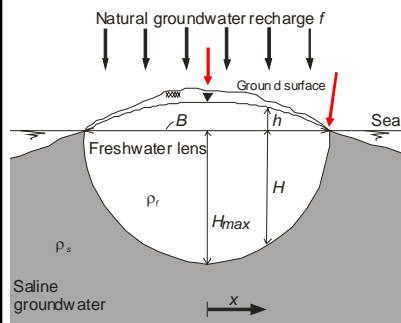

Boundary conditions

$$x = 0 : q = 0 \rightarrow C_1 = 0$$

$$x = 0.5B : H = 0 \rightarrow C_2 = fB^2 / 8$$

Example of analytical solutions (I)

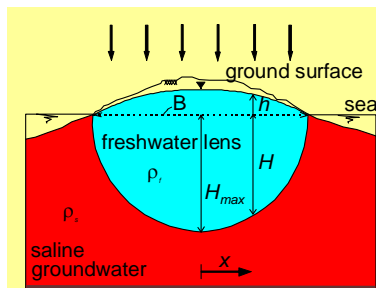

Depth of fresh-saline interface H

$$H = \sqrt{\frac{f(0.25B^2 - x^2)}{k\alpha(1+\alpha)}}$$

$$h = \alpha H$$

Maximal thickness lens

$$H_{\max} = \frac{1}{2}B \sqrt{\frac{f}{k\alpha(1+\alpha)}}$$

Volume lens

$$V = \frac{1}{4}\pi(1+\alpha)H_{\max} B n_e$$

$$\text{Characteristic time } T = \frac{\text{volume of water in lens}}{\text{inflow of water}} = \frac{\pi n_e B}{8} \sqrt{\frac{(1+\alpha)}{kf\alpha}}$$

Lecture notes p. 32

Example of analytical solutions (I)

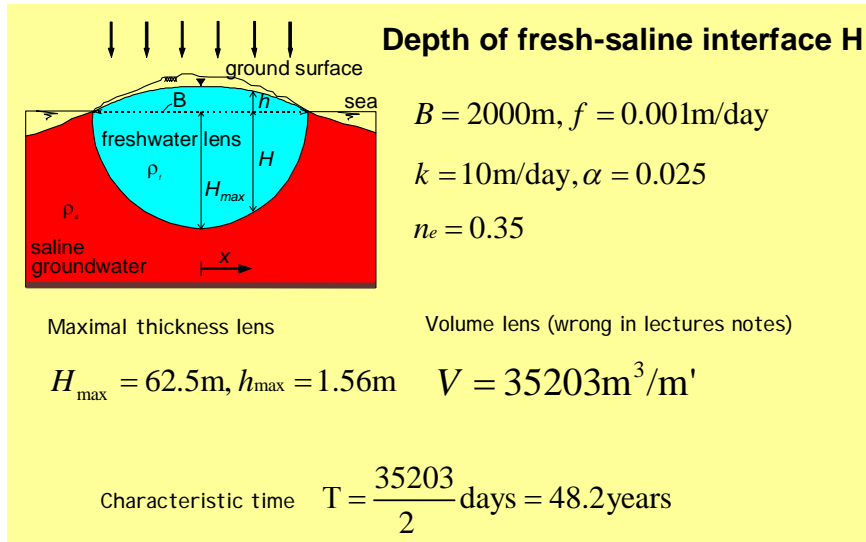

Lecture notes p. 32

Example 2: salt water wedge

$$H = \sqrt{\frac{-fx^2 - 2C_1x + 2C_2}{k\alpha(1+\alpha)}} \quad q = fx + C_1$$

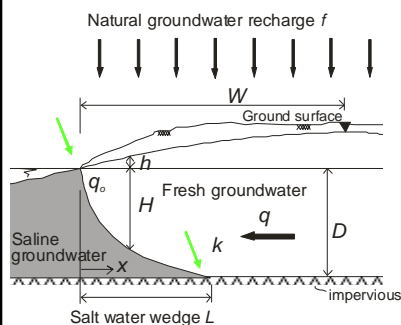

Boundary conditions

$$x = 0: q = q_0 \rightarrow q_0 = -fW \rightarrow C_1 = q_0$$

$$x = 0: H = 0 \rightarrow C_2 = 0$$

Length of salt water wedge

$$x = L: H = D$$

Example of analytical solutions (II)

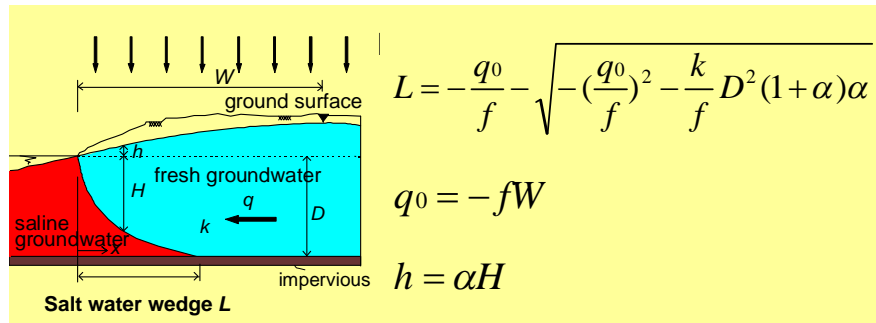

Example:

$$W = 3000 \text{ m}, f = 0.001 \text{ m/day}, \alpha = 0.020, k = 20 \text{ m/day}, D = 50 \text{ m}$$

$$L = 175.1 \text{ m}$$

Lecture notes p. 33

Length of the salt water wedge as a function of a. recharge and b. hydraulic conductivity

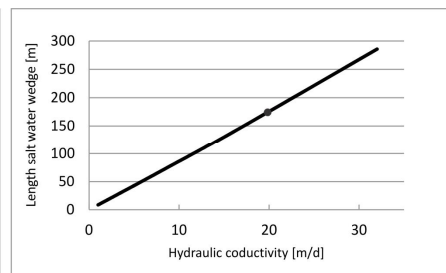
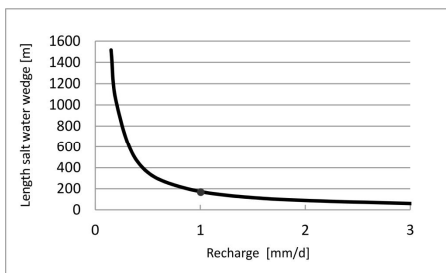

the dots resample with the example mentioned above

Confined aquifer (1D situation)

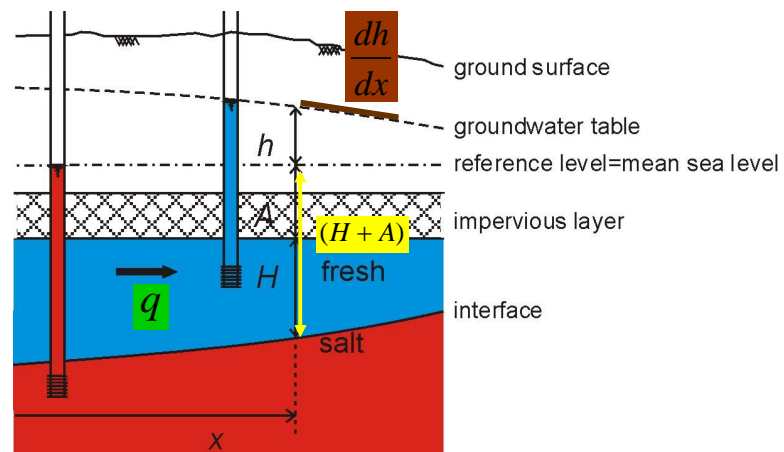

Confined aquifer (1D situation)

(I) Darcy $q = -kH \frac{dh}{dx}$

(II) Continuity $q = q_o$

(III) BGH $h = \alpha(H + A)$

Confined aquifer (1D situation)

$$-kH \frac{dh}{dx} = q_0$$

$$HdH = -\frac{q_0}{k\alpha} dx$$

integration gives

$$\frac{1}{2} H^2 = \frac{q_0 x}{k\alpha} + C$$

$$H = \sqrt{-\frac{2q_0 x}{k\alpha} + 2C}$$

Example 3: salt water wedge confined aquifer

$$H = \sqrt{-\frac{2q_0 x}{k\alpha} + 2C}$$

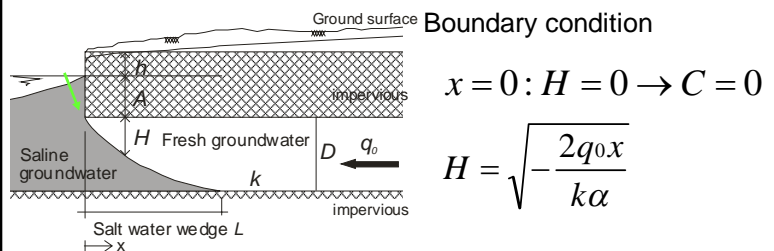

Length of salt water wedge $x = L : H = D$

$$L = -\frac{kD^2\alpha}{2q_0}$$

Example of analytical solutions (III)

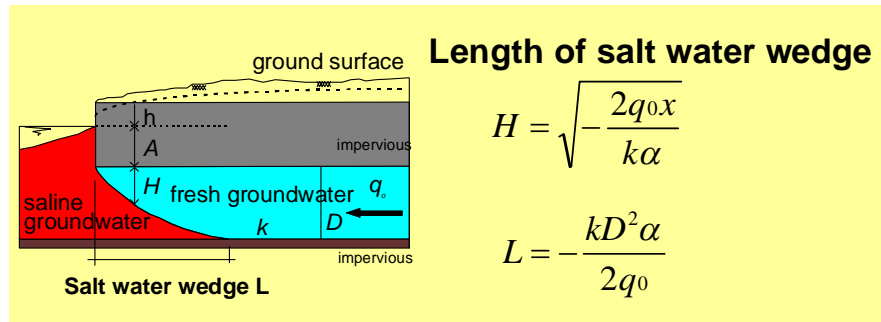

Example:

$W = 2000\text{m}$, $f = 0.001\text{m/day}$, $\alpha = 0.025$, $k = 25\text{m/day}$, $D = 40\text{m}$

$L = 250\text{m}$

Lecture notes p. 35-36

Outflow face (Submarine Groundwater Discharge)

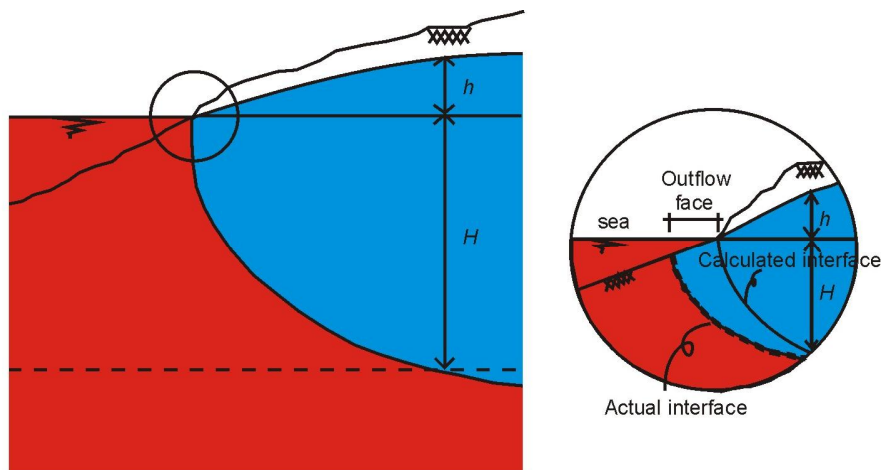

Outflow face (Submarine Groundwater Discharge)

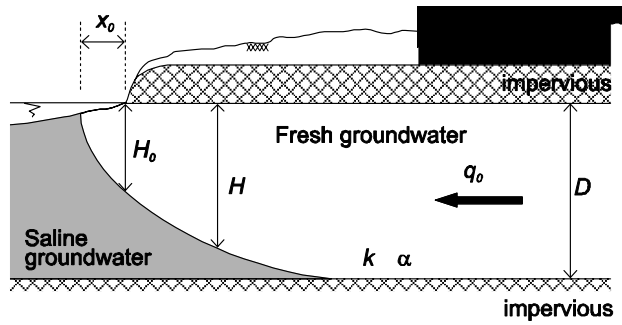

$$x_0 = \frac{q_0}{2k\alpha} \quad H_0 = \frac{q_0}{k\alpha} \quad \text{Glover (1959)}$$

Example:

$$x_0 = \frac{f \cdot L}{2ka} = \frac{0.001 \text{ m/d} \cdot 20000 \text{ m}}{(2 \cdot 20 \cdot 0.025)} = 20 \text{ m (only!)}$$

Note: no resistance layer offshore

Outflow face (Submarine Groundwater Discharge)

Embayment Scale

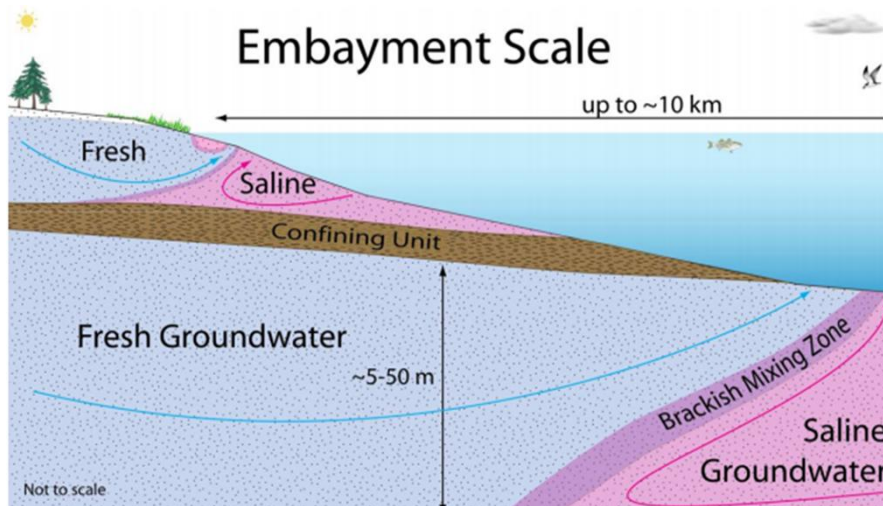

Outflow face (Submarine Groundwater Discharge)

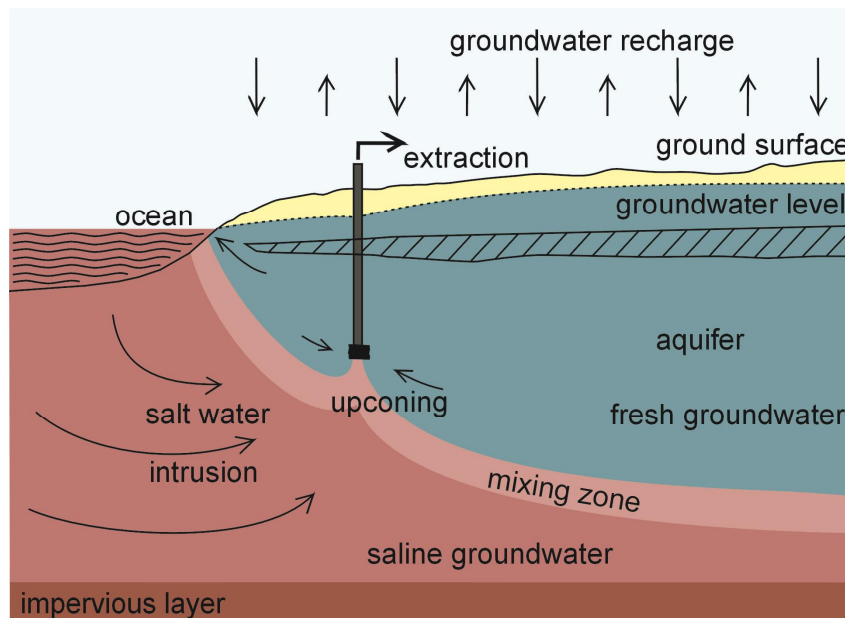
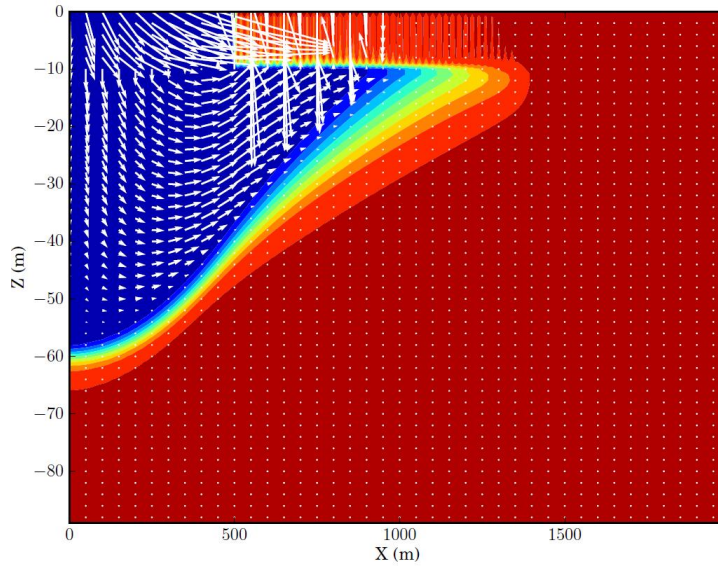

See the lectures for more cases

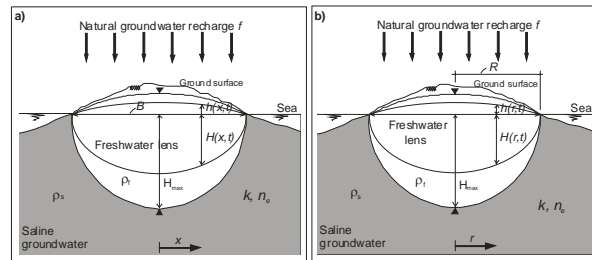
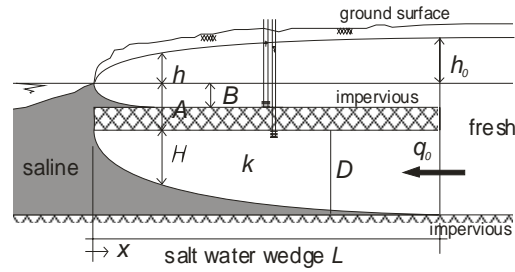

Upconing processes

Upconing of saline groundwater

Under an extraction well

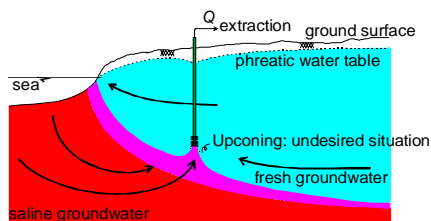

Under a low-lying polder area

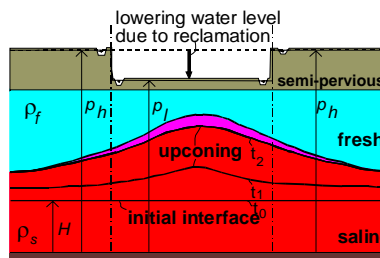

- movement of saline groundwater to extraction wells
- increase in salinity (>150-200 mg Cl-/l)
- lowering of the piezometric head (leads to land subsidence: e.g. Los Angeles: 9 m in the 1930's)

'Solutions': reduce extraction rate, abandon well, inundate polder

Examples of analytical solutions (IV)

Upconing of saline groundwater under an extraction well

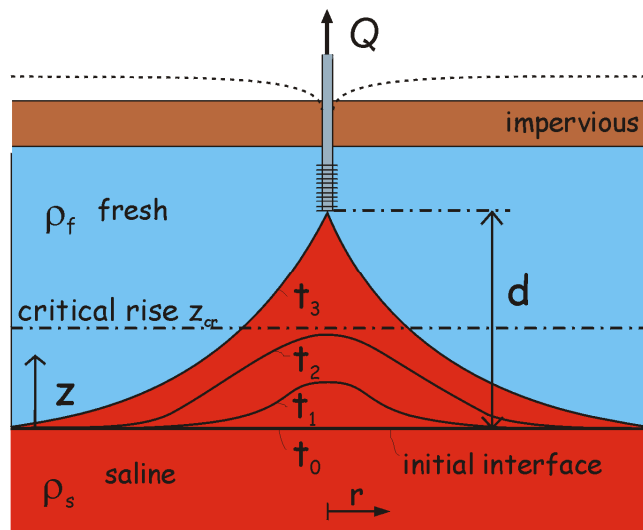

Lecture notes p. 44

Situation Jurong Island: pilot extraction well

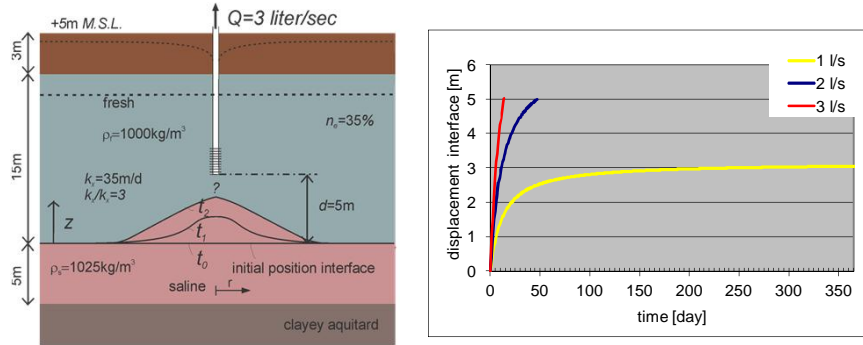

- Distance between well screen and initial interface: 5m
- Rapid upconing of interface, depending on extraction rate
- No saline groundwater in extraction well with scenario 1 l/s
- Good set-up for testing system

Situation Jurong Island: pilot extraction well: d=10m!

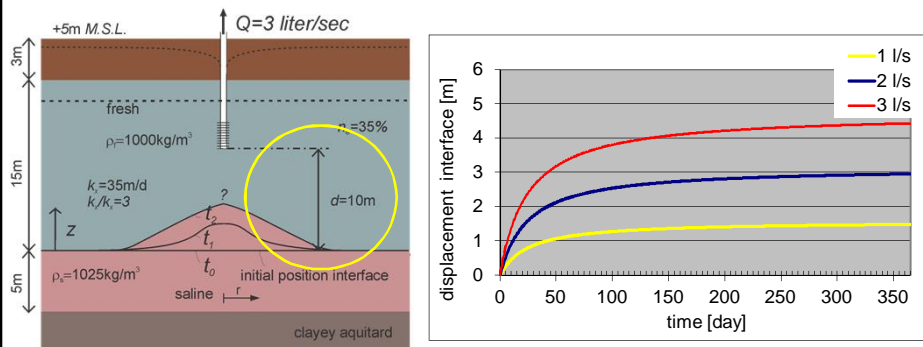

- Distance between well screen and initial interface: not 5 but 10m
- No saline groundwater in extraction well with all three scenarios
- Less interesting for testing system

Examples of analytical solutions (IV)

Upconing of saline groundwater under an extraction well

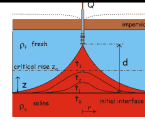

$$z(r, t) = \frac{Q}{2\pi\alpha k_x d} \left[\frac{1}{(1 + R'^2)^{1/2}} - \frac{1}{[(1 + \gamma')^2 + R'^2]^{1/2}} \right]$$

$$R' = \frac{r k_z}{d k_x} \quad \gamma' = \frac{\alpha k_z}{2n_e d} t$$

Dagan & Bear, 1968, J. Hydraul. Res 6, 1563-1573

Lecture notes p. 44

Upconing of salt under an extraction

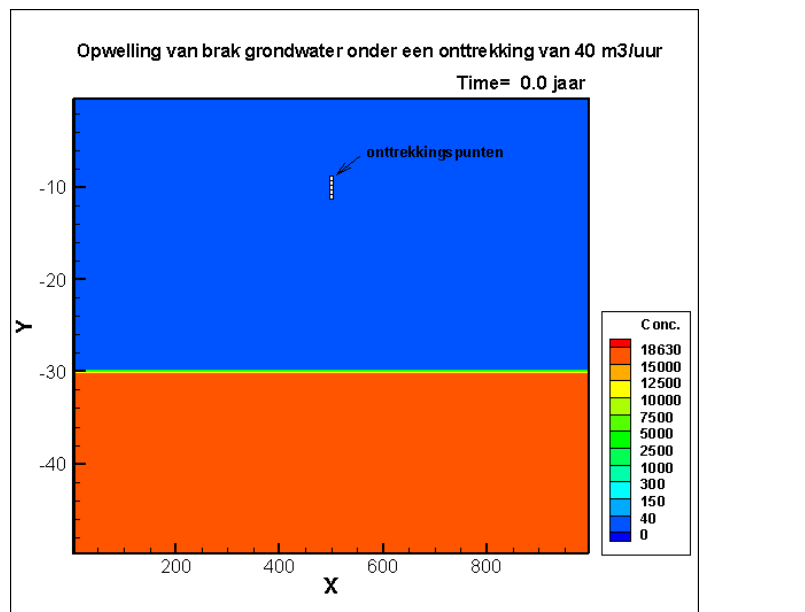

Upconing under a low-lying polder (Groot-Mijldrecht)

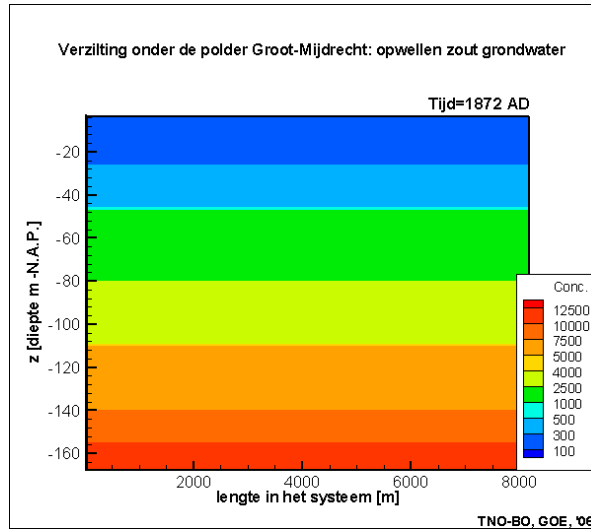
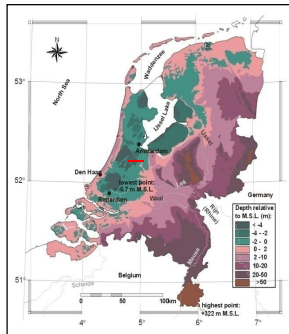
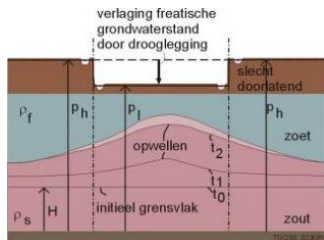

Upconing under a low-lying polder (Groot-Mijldrecht)

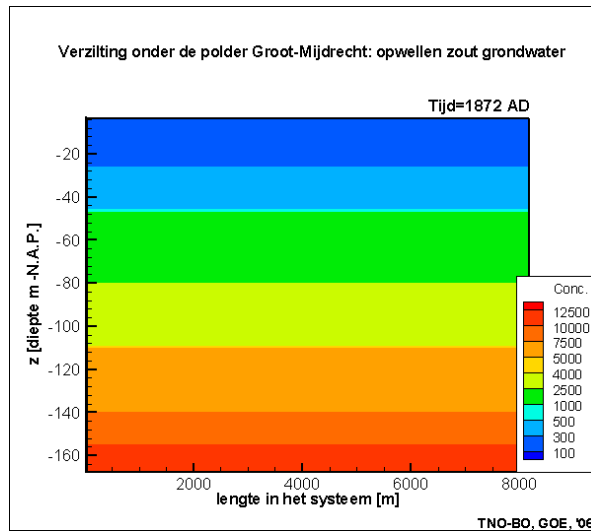
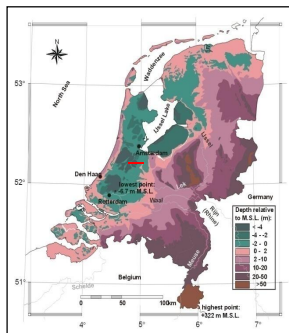
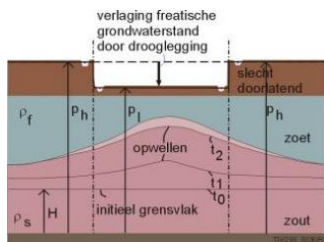

Upconing under a low-lying polder (Groot-Mijdrecht)

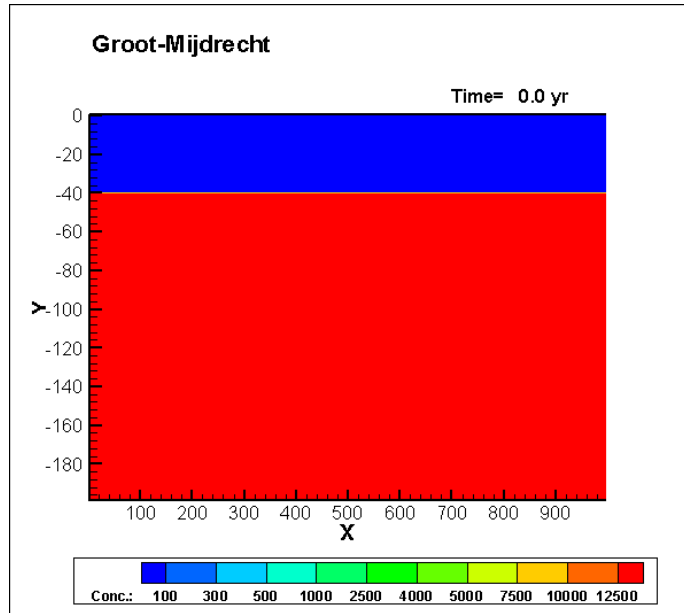

Upconing under a low-lying polder (Groot-Mijdrecht)

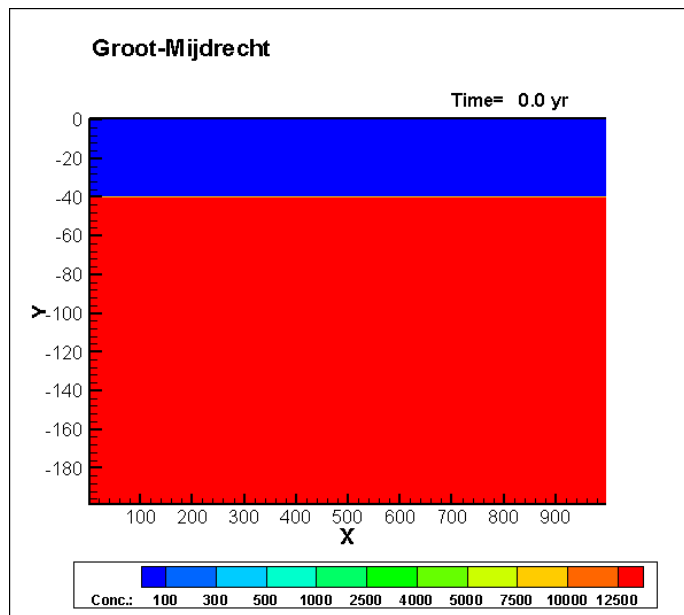

Fresh-salt interface (150 mg Cl⁻/l)

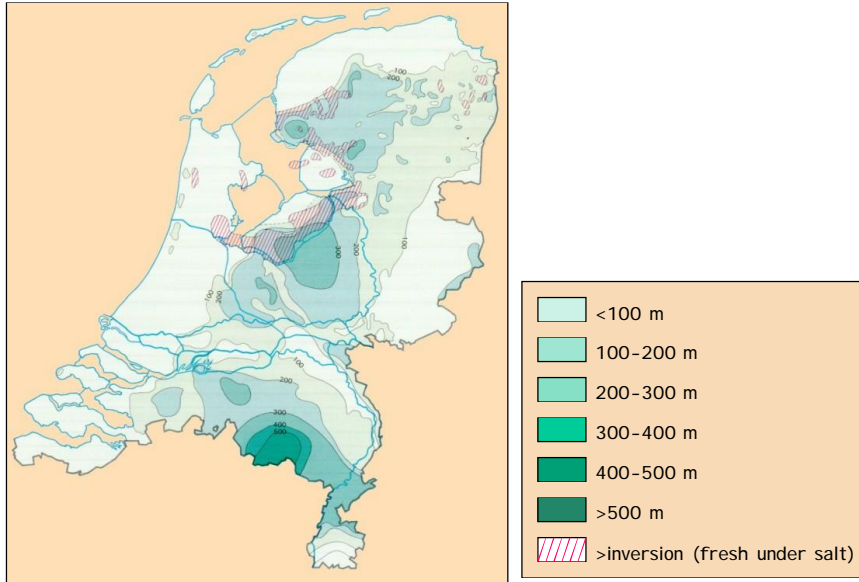

Availability of fresh groundwater

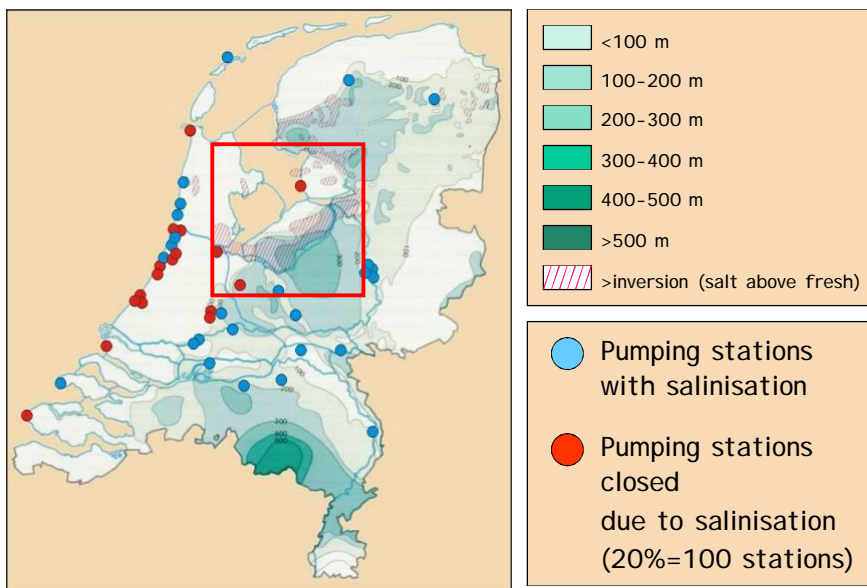

Different risks of upconing saline groundwater

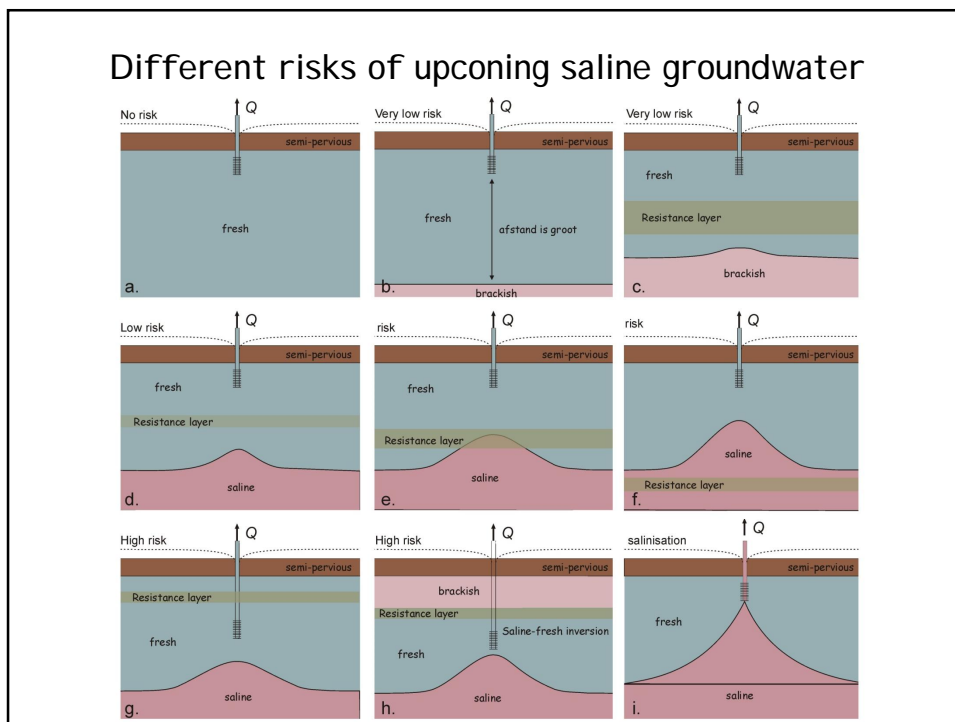

Animation 3D Chloride concentration

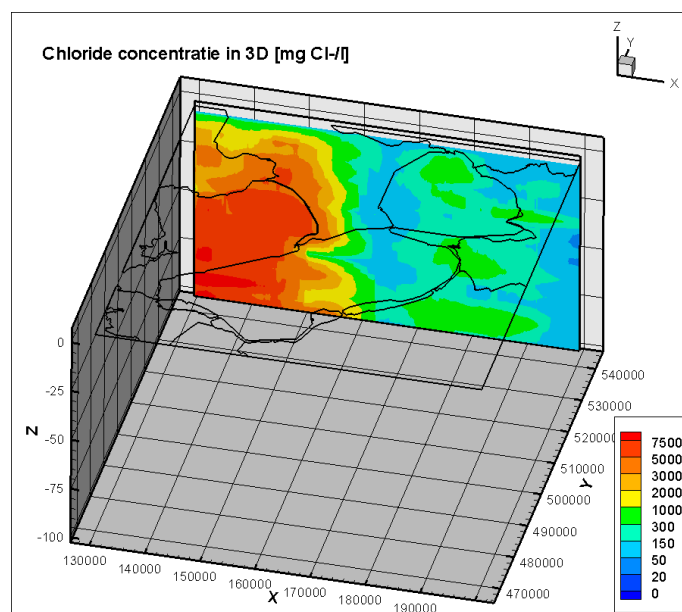

Upconing in Flevoland

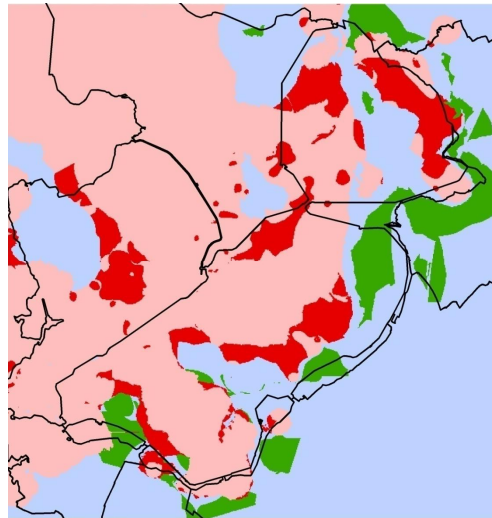

Risk depends on:

- Initial position interface
- Resistance layers
- Existence inversion
- Extraction rate and scheme



Compensating measures

Possible solutions to stop salt water intrusion:

- Restriction of groundwater extractions through permits
- Co-operation between authorities and water users
- Desalinisation of saline water
- Technical countermeasures of salt water intrusion
 - six examples

Tools to understand salt water intrusion:

- Monitoring of salinities and piezometric levels
- Numerical modelling of salt water intrusion

Measures to compensate salt water intrusion

- 'The Fresh Holder'
- Extraction of saline/brackish groundwater
- Infiltration of fresh surface water
- Modifying pumping rates
- Land reclamation in front of the coast
- Creating physical barriers (chrySTALLISATION or biosealing)

Aquifer Storage and Recovery

"potential to be a major contribution to UN Millennium Goals for Water Supply"

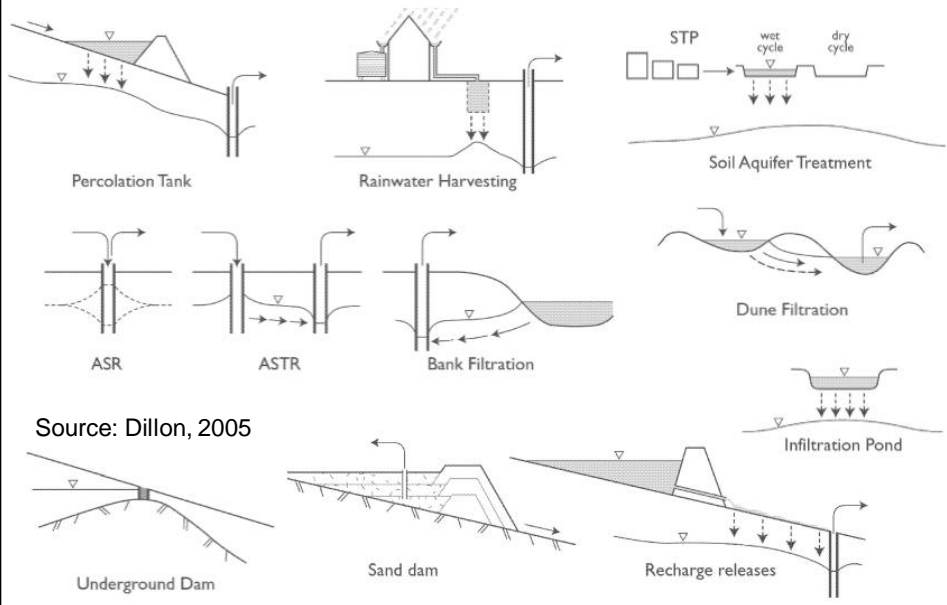

Source: Dillon, 2005

Aquifer Storage and Recovery / Managed Aquifer Recharge

"potential to be a major contribution to UN Millennium Goals for Water Supply"

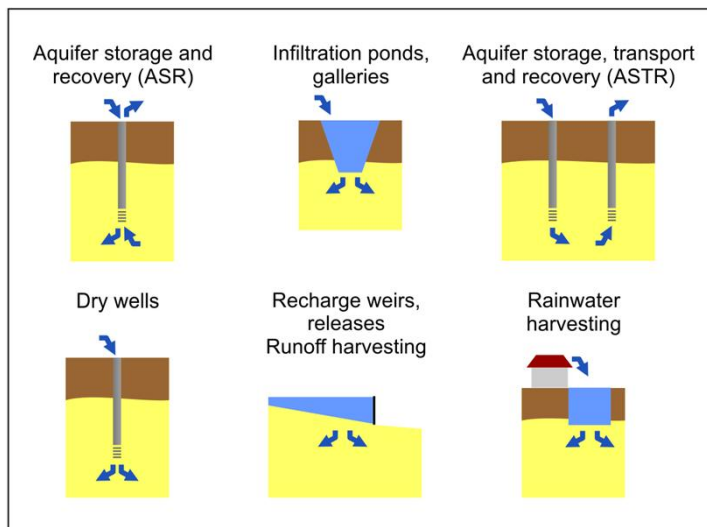

Source: Dillon, 2005

Technical measures to compensate salt water intrusion

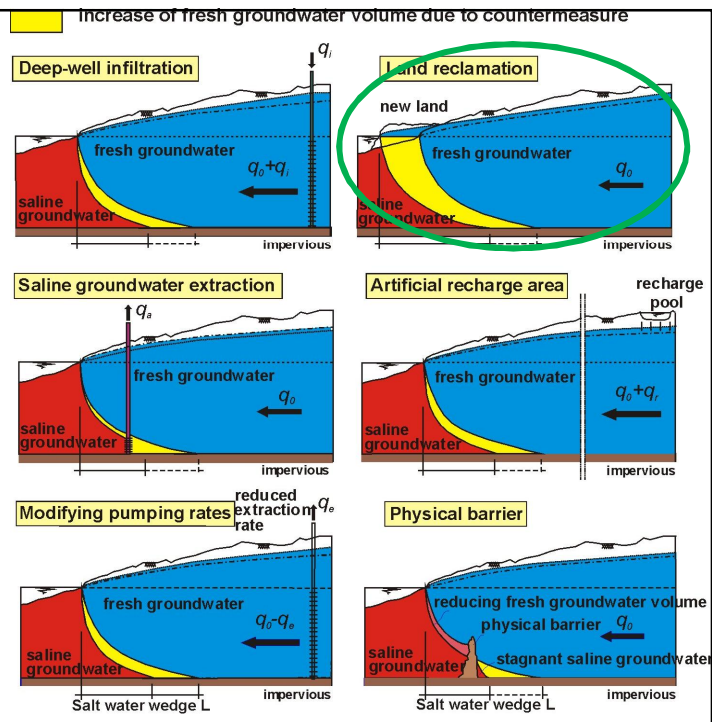

Land reclamation

The Zandmotor: effects at the hinterland?



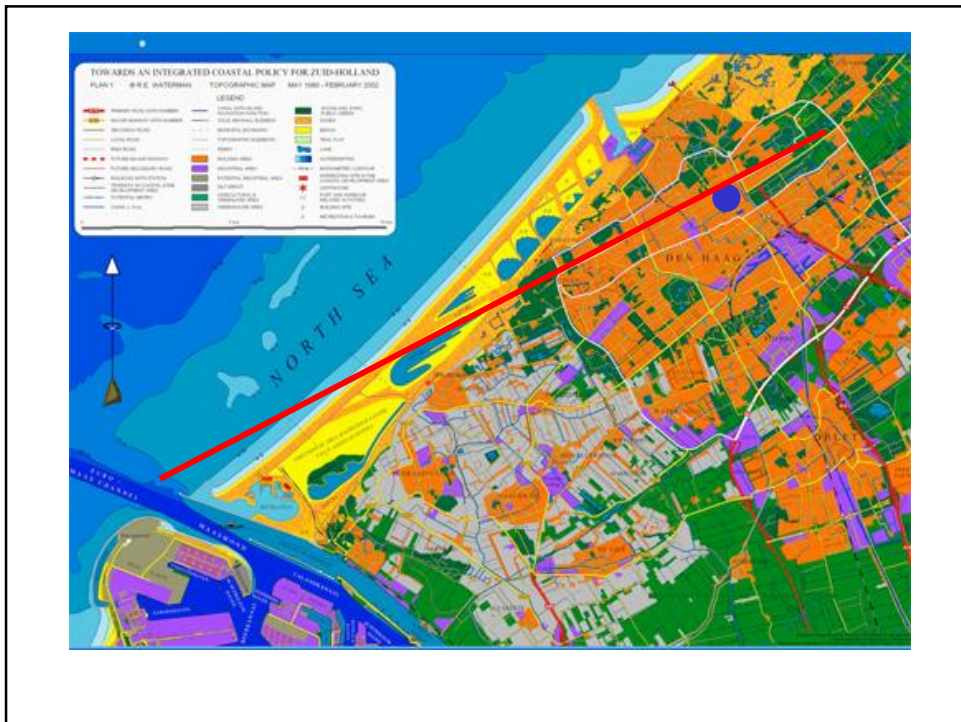
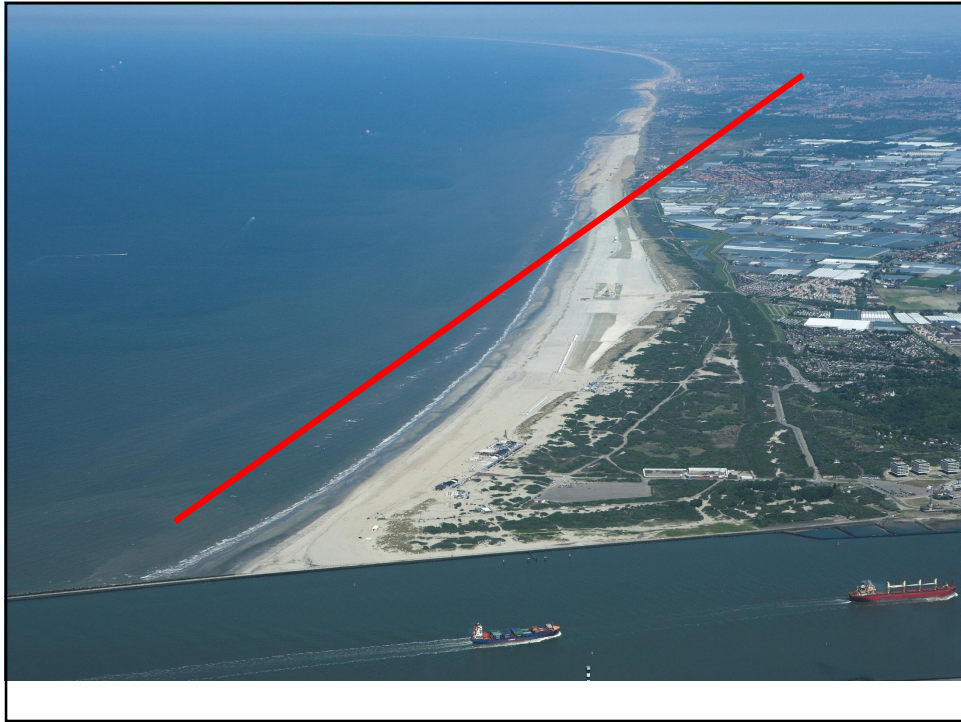

The Zandmotor: effects at the hinterland?



The Zandmotor
storage extra
fresh water?

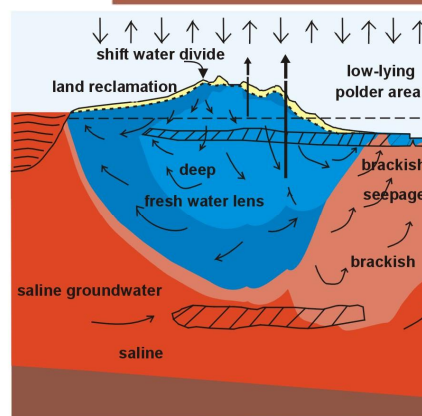
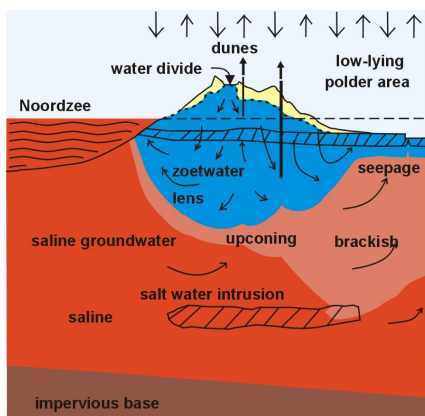
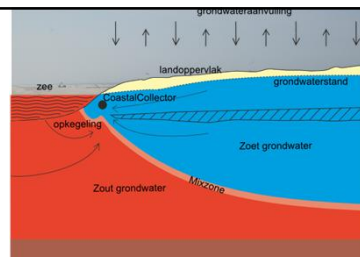

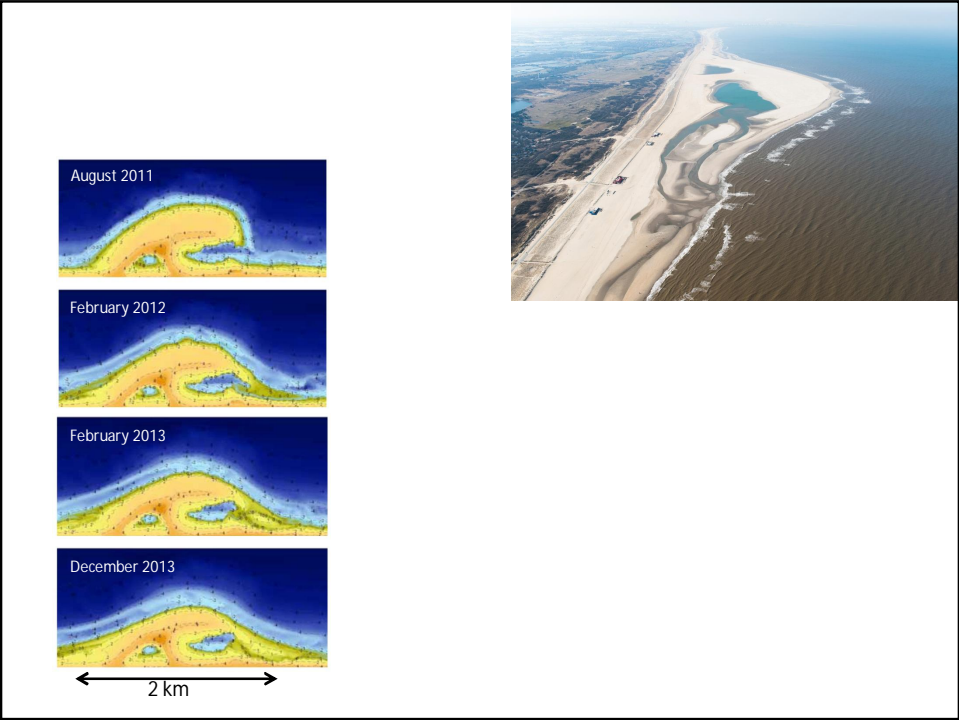
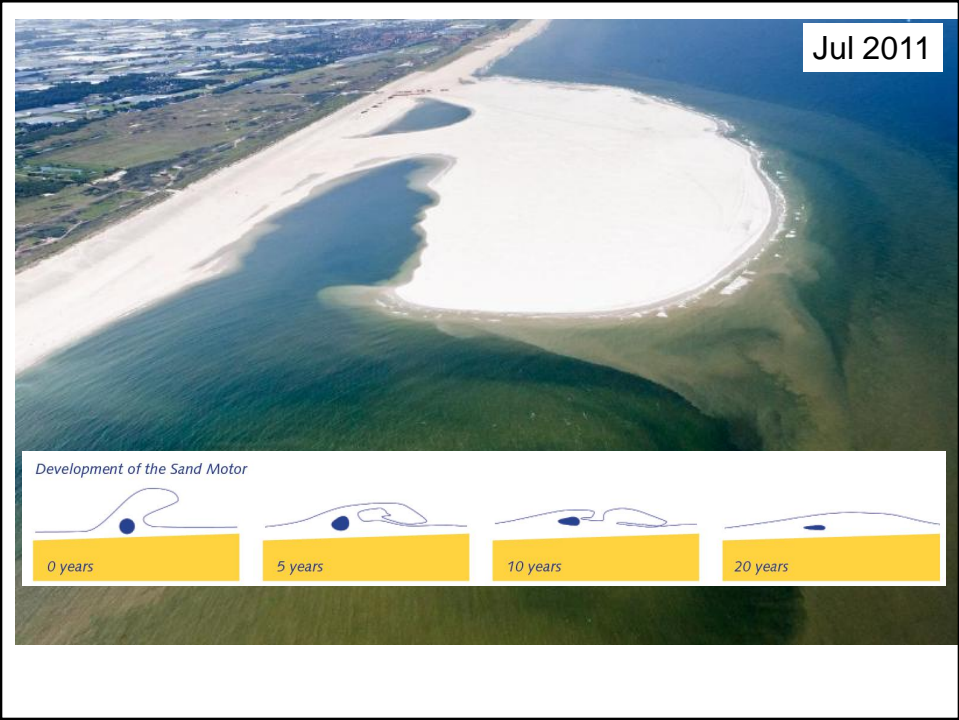

The Coastal Collector

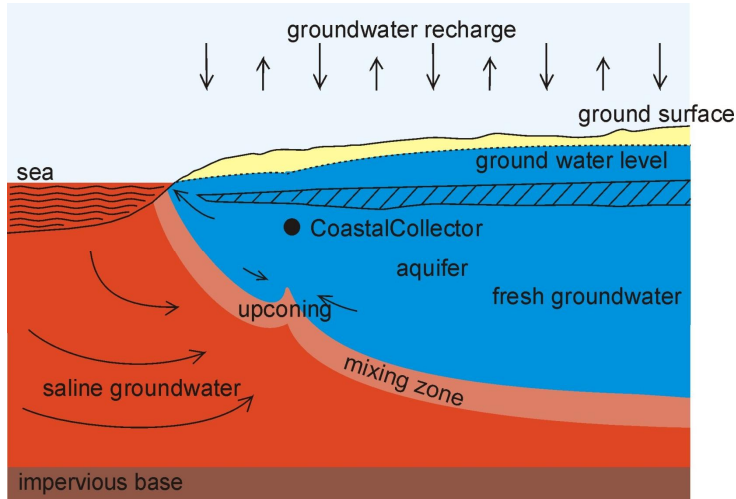

Technical measures to compensate salt water intrusion

increase of fresh groundwater volume due to countermeasure

Deep-well infiltration

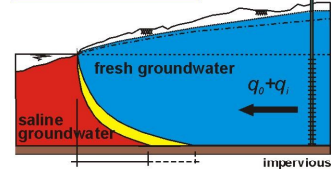

Land reclamation

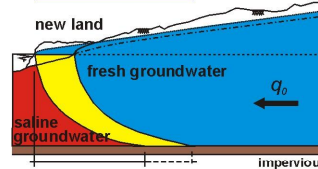

Saline groundwater extraction

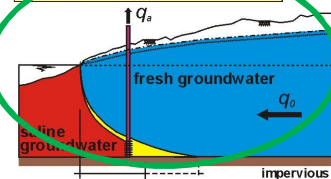

Artificial recharge area

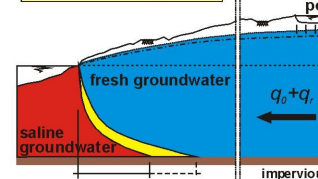

Modifying pumping rates

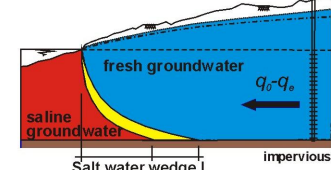

Physical barrier

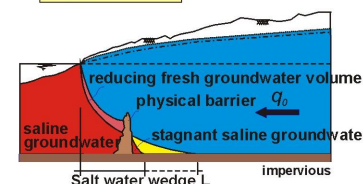

Solution: The Fresh Holder

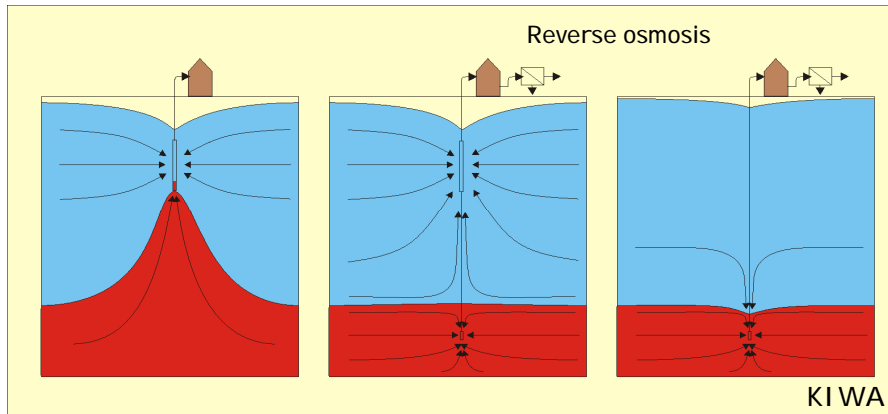

Upconing can be prevented by the extraction of brackish groundwater
 This brackish groundwater can be transformed to water of agricultural water quality by using the membrane filtration technique

COASTAR: COastal Aquifer STORAGE And Recovery

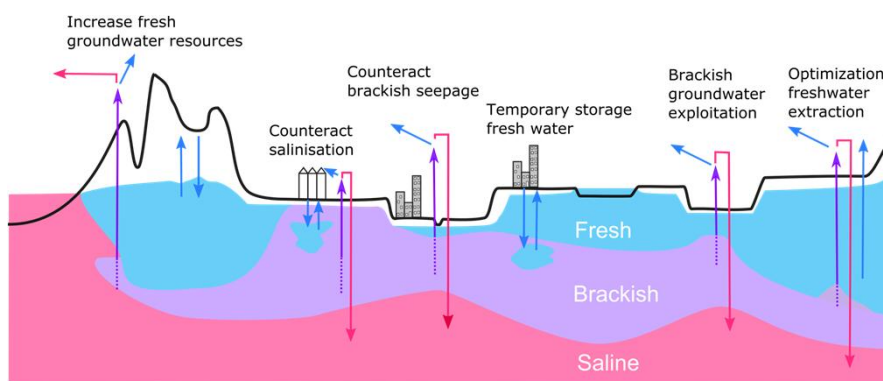

Countermeasures of salt water intrusion

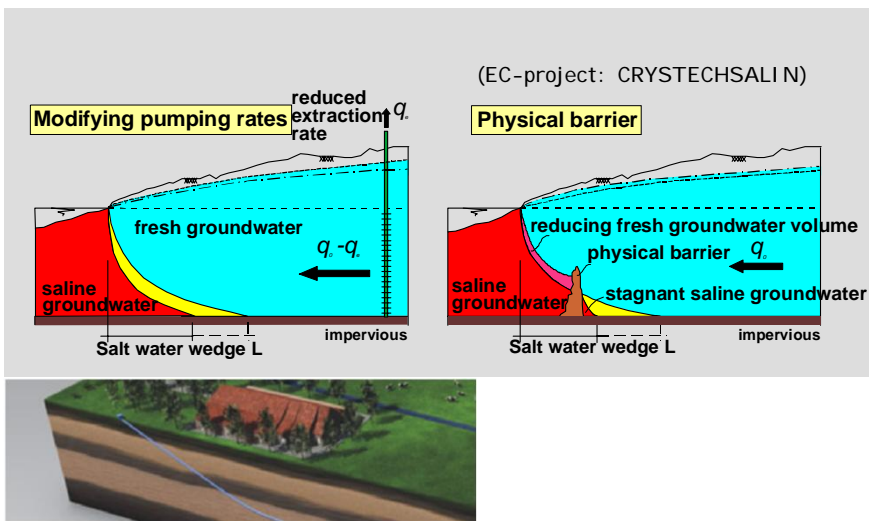

Technical measures to compensate salt water intrusion

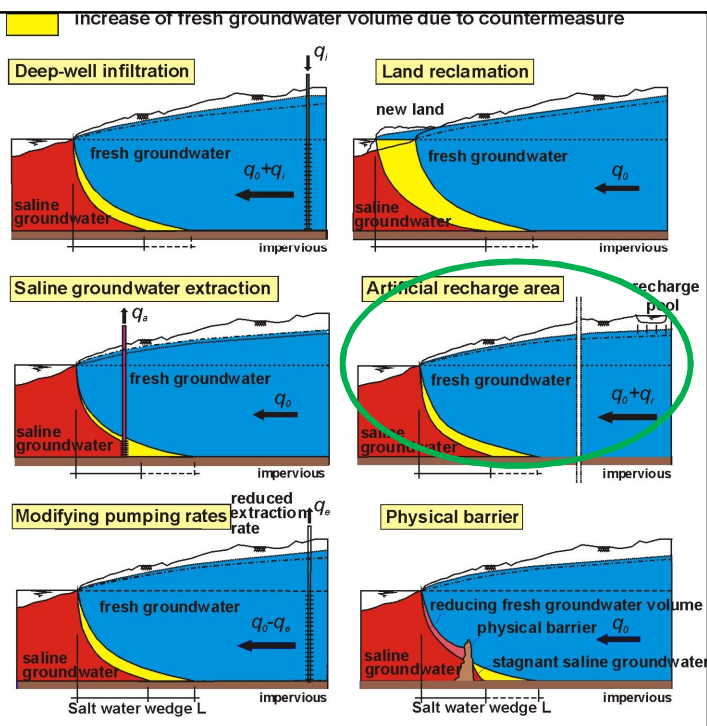

Base idea

Many local solutions for fresh groundwater supply can have regional impact

Starring

solution fresh groundwater supply

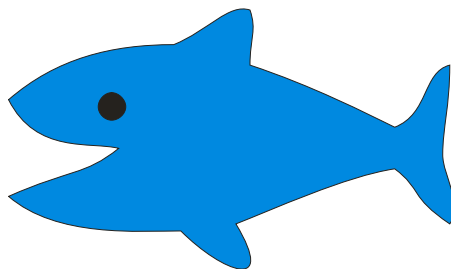

Starring

Local solution fresh groundwater supply



Starring

climate and global change



Starring

climate and global change



Solutions and responses

Local solution fresh groundwater supply

climate and global change



What should be the response?

Many local solutions fresh groundwater supply

climate and global change

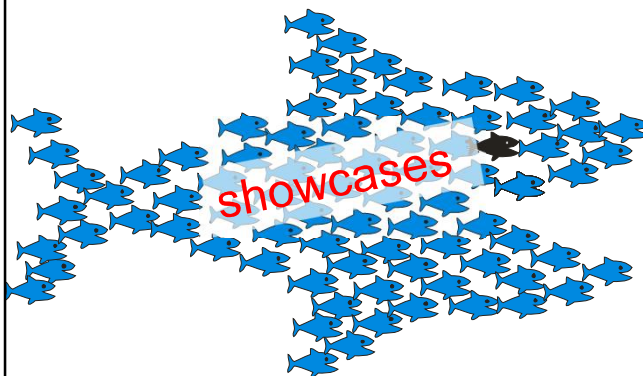

Many local solutions for fresh groundwater supply can have regional impact!

- upscaling local cases to regional strategy
- assess economical feasibility
- increase impact: communicate our showcases
- working together

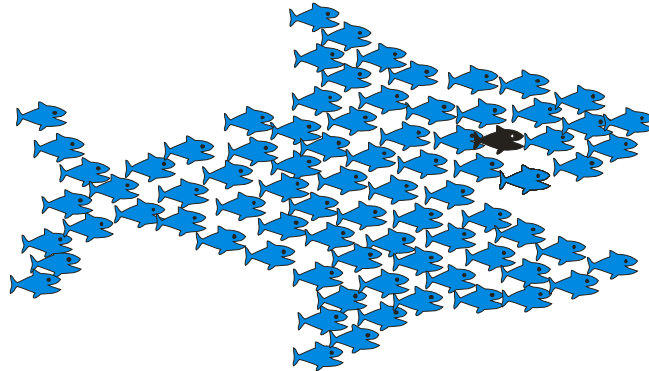

Aquifer Storage and Recovery in the coastal zone



Goal:

Increase fresh groundwater resources in saline seepage areas in the southwestern part of the Dutch Delta

Methods:

3 pilot studies: infiltration of fresh water in times of water excess and extraction in times of droughts

www.go-fresh.info

Many small local solutions together can be enough for a regional fresh water supply

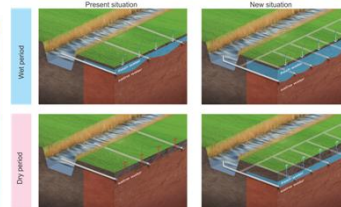
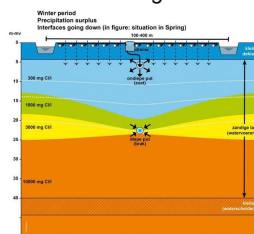
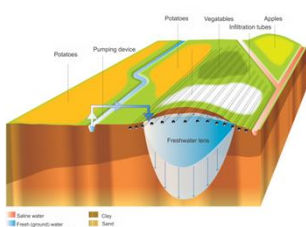

Creekridge Infiltration Test

Increase fresh water in creek ridge by injection of fresh surface water and extraction of saline groundwater

The Freshmaker

Increase fresh water volume in creek ridge by passive infiltration via drainage

Drains2Buffer

Maintain fresh water volume in shallow rainwater lenses by smart deep controlled drainage

Problem statement

- Crop damage southwestern part of the Netherlands
- Fresh groundwater below creek ridges



Case study: Water Farm

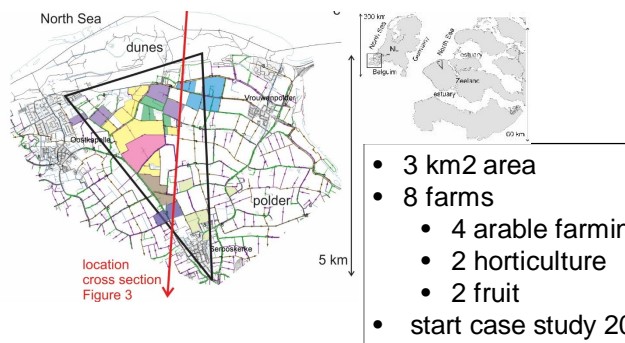

- 3 km² area
- 8 farms
 - 4 arable farming
 - 2 horticulture
 - 2 fruit
- start case study 2010

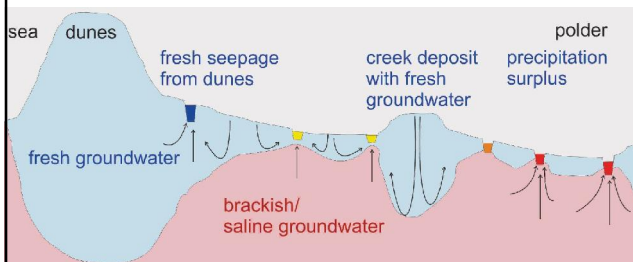

- measures
- communication to outside world



Researchers: scenario analysis

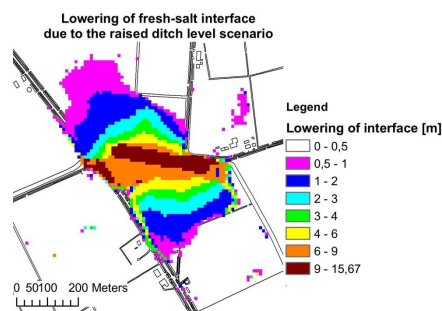

Creek ridges

1200 AD; before land reclamation

current situation

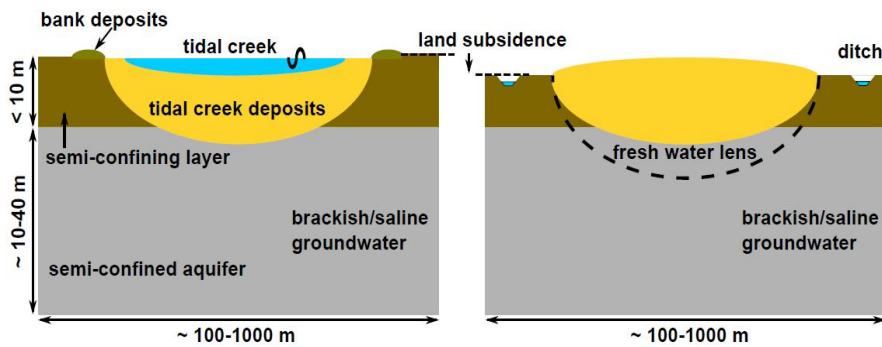

Measure

- Controlled level drainage
- Increase groundwater level

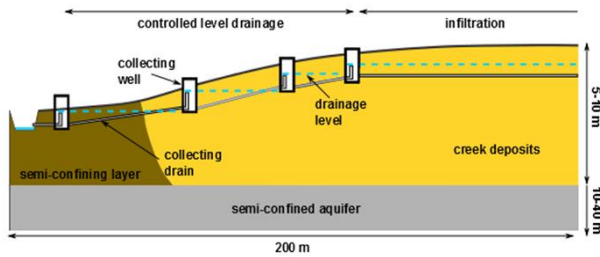

Creekridge Infiltration System

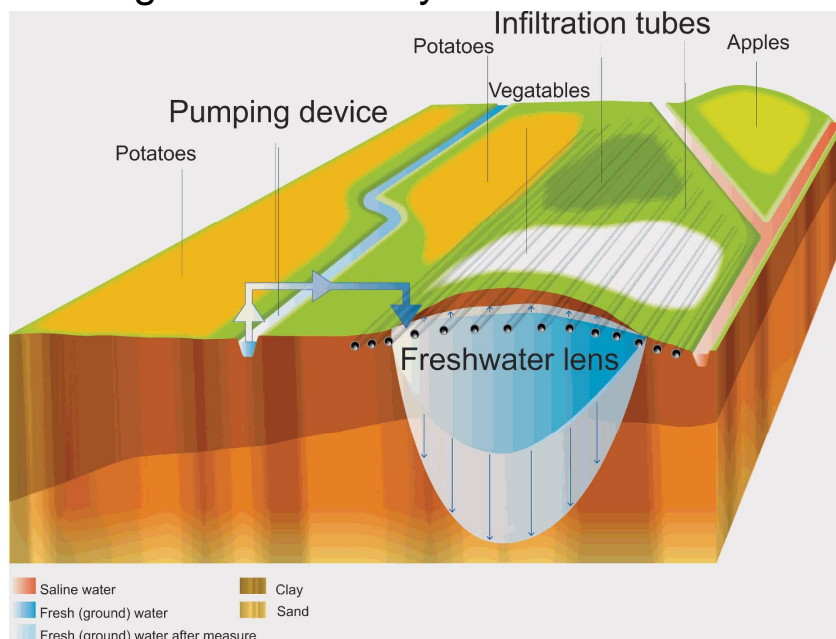

Concept of CARD and pilot layout

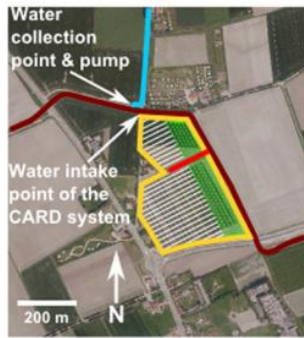
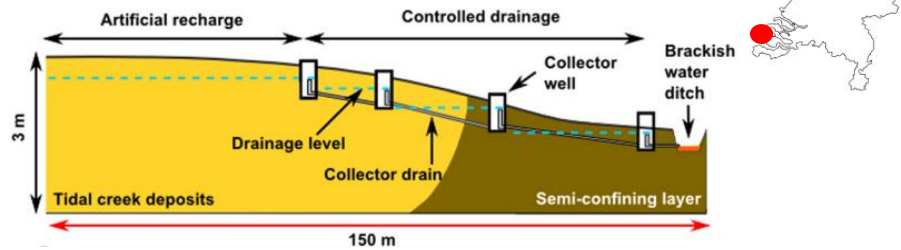

Legend

- Extent CARD system
- Location of the cross section show in a
- Fresh water ditch
- Brackish/saline water ditch
- Artificial recharge
- Controlled drainage

Installation of drainage and monitoring network

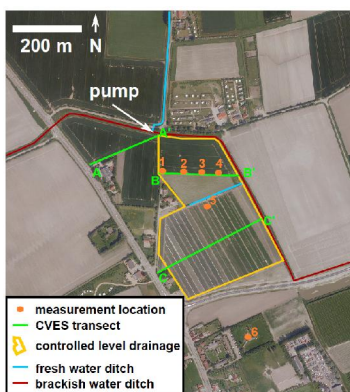

various types of field measurements

Different types of field measurements applied

Measurement type	Purpose
Pressure transducers ^a	Groundwater levels
Sampling using piezometer nest	EC _{w20}
SLIMFLEX ^b	EC _{bulk}
CPT ^c	Lithology and EC _{bulk}
CVES ^d	EC _{bulk}
SMD ^e	EC _{bulk}

- a. Schlumberger, The Netherlands (type 'Diver')
- b. Deltares, The Netherlands
- c. Fugro, The Netherlands
- d. ABEM, Sweden
- e. Imageau, France

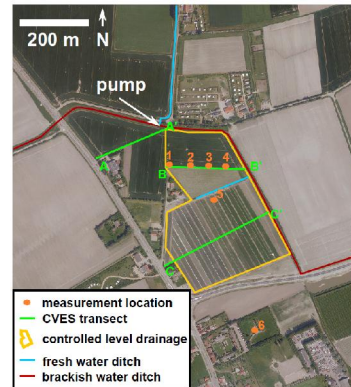

Key field observations (1)

- Fresh groundwater up to -12 m NAP

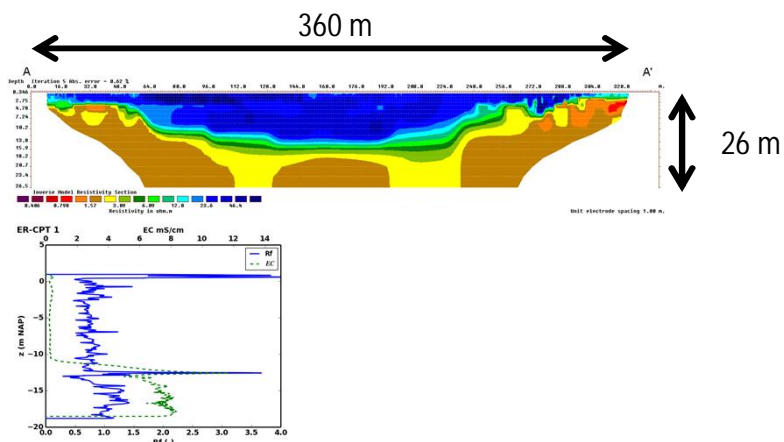

Key field observations (2)

- Freshening up to 2m

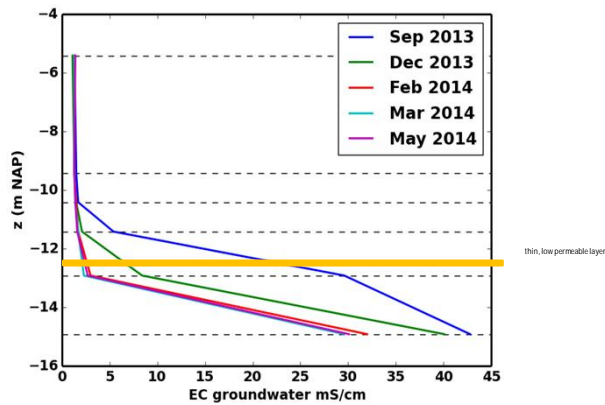

Subsurface Monitoring Device (SMD): Monitoring salinities

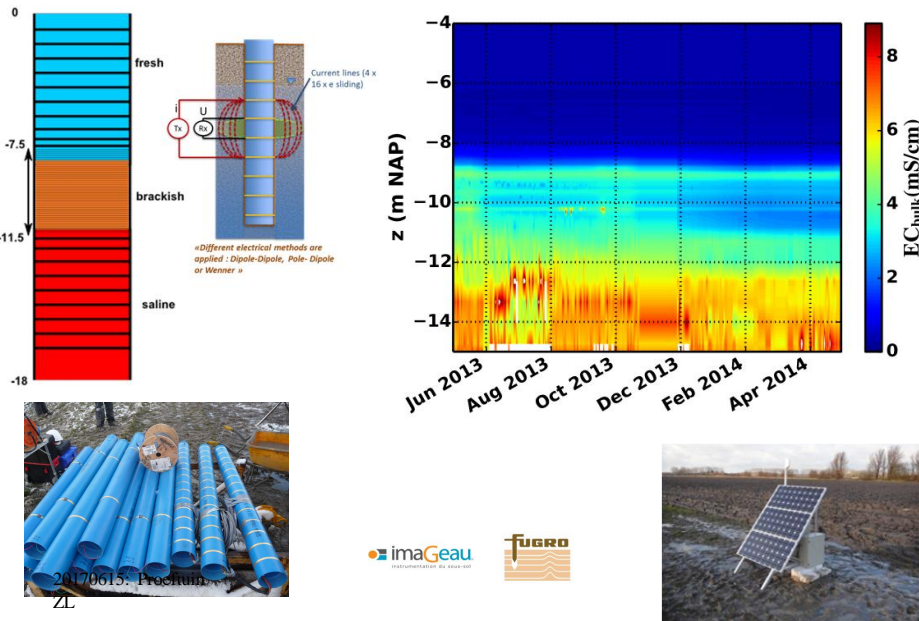

Key field observations (3)

- Groundwater levels and precipitation

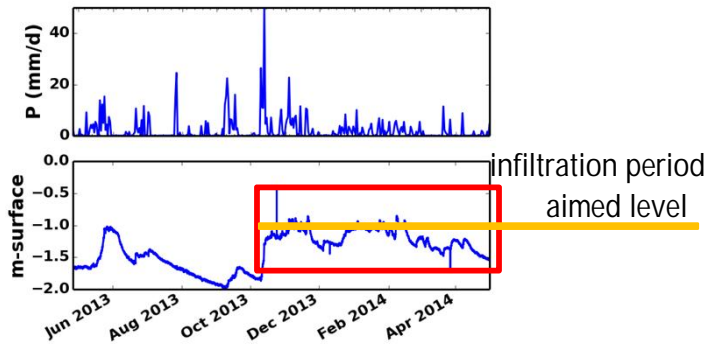

Modeling

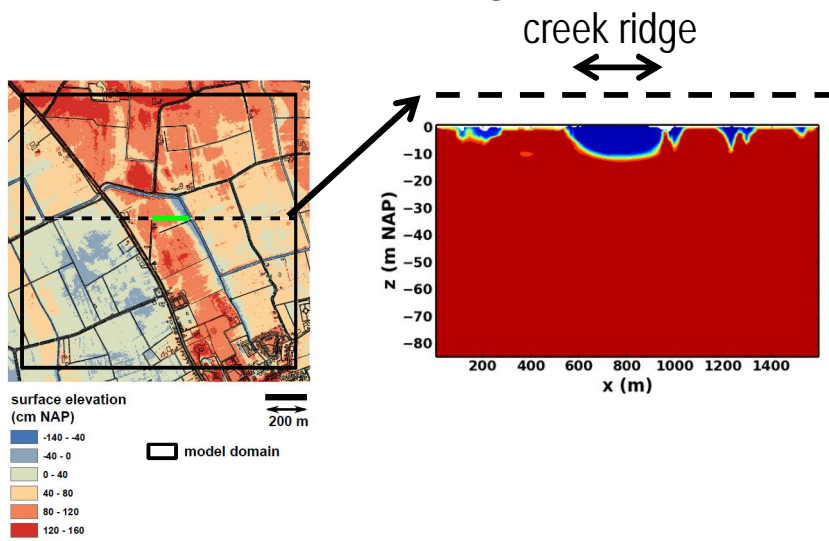

Influence of infiltration

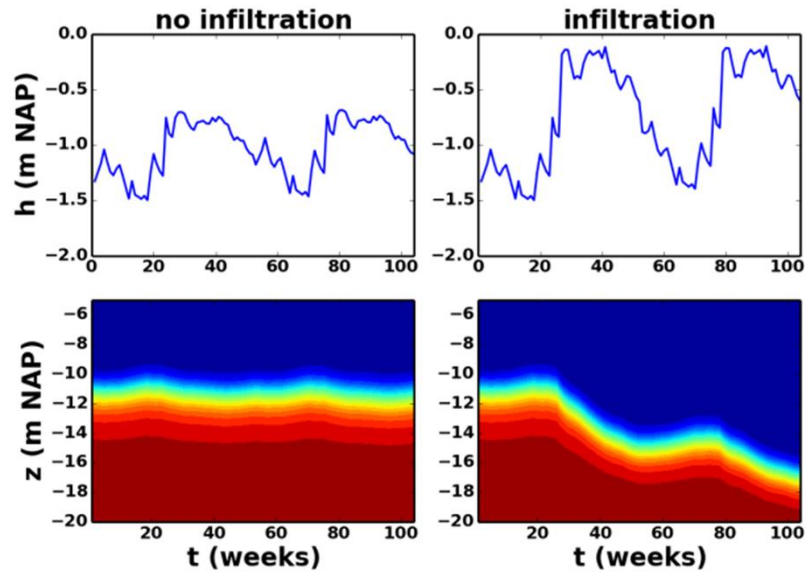

Example NL:
Salt resistant crops on salty boils



Cl-conc seepage:

(Polder Noordplas)

Diffuse : 100 mg/l

Paleochannel : 600 mg/l

Boils : 1100 mg/l



Ask Perry de Louw for details

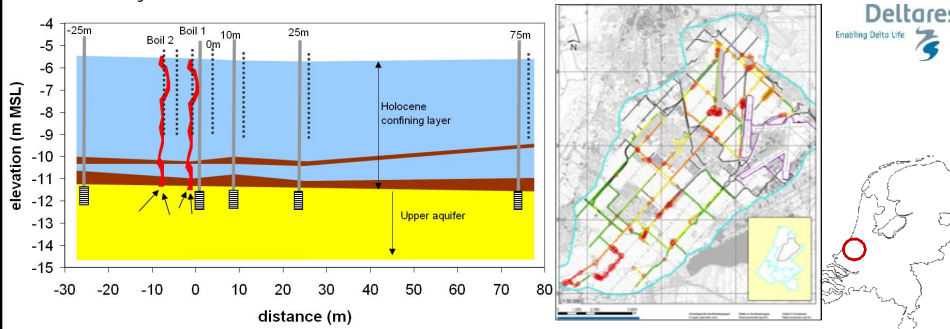

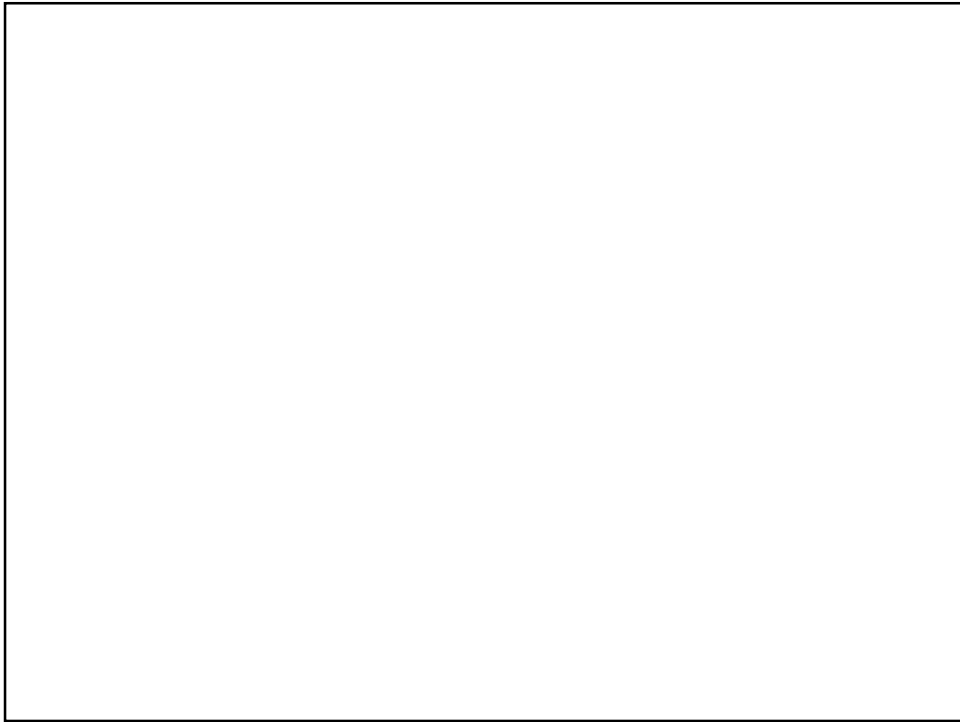

Modelling

salt water intrusion
density dependent groundwater flow

Why mathematical modelling anyway?

A model is only a schematisation of the reality!

Why mathematical modelling anyway?

+:

- cheaper than scale models
- analysis of very complex systems is possible
- a model can be used as a database
- to increase knowledge about a system (water balances)

-:

- simplification of the reality
- only a tool, no purpose on itself
- garbage in=gabrage out: (field)data important
- perfect fit measurement and simulation is suspicious

Numerical modelling variable density flow

Type:

- sharp interface models
- solute transport models

State of the art:

- three-dimensional
- solute transport
- transient

3D numerical models groundwater coastal zone

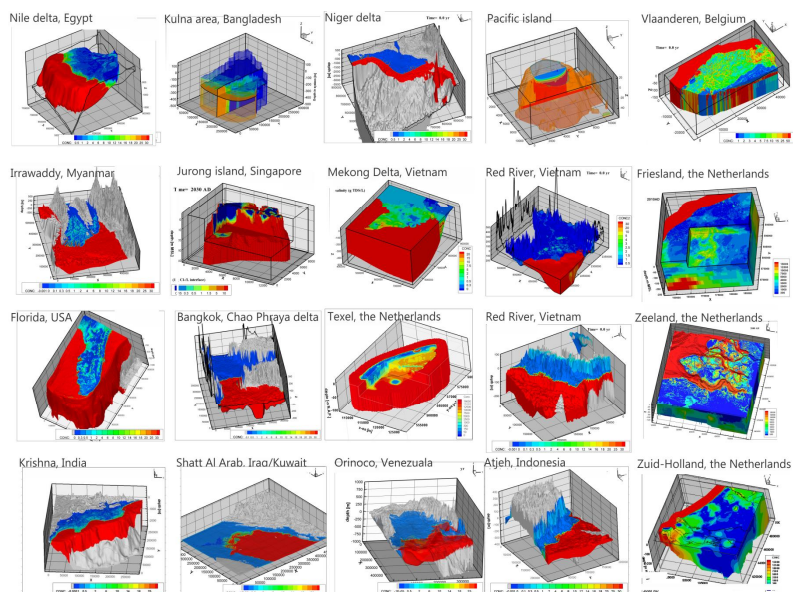

Some existing 3D codes which simulate variable density groundwater flow in porous media:

SEAWAT (<i>Guo & Bennett, '98</i>)	SWICHA (<i>Huyakorn et al., '87</i>)
METROPOL (<i>Sauter, '87</i>)	SWIFT (<i>Ward, '91</i>)
FEFLOW (<i>Diersch, '94</i>)	FAST-C 3D (<i>Holzbecher, '98</i>)
MVAEM (<i>Strack, '95</i>)	MODFLOW+MT3D96 (<i>Gervern, '98</i>)
D3F (<i>Wittum et al., '98</i>)	HST3D (<i>Kipp, '86</i>)
MOCDENS3D (<i>Oude Essink, '98</i>)	SUTRA (beta-version, <i>Voss, '02</i>)
HydroGeoSphere (<i>Therrien, '92</i>)	

Fresh-salt groundwater modelling issues

1. Grid convergence
2. Vert-hor displacement interface
3. Transient versus Steady-state
4. Salt BC: e.g. far enough for the area of interest, BC zz 3D model
5. Do not trust solvers default: e.g. Case Nile delta
6. Rotation mixing, effect of dispersion
7. Big delta systems and drain-river packages: there is always a drainage system around
 - a. Conductance for large cells
 - b. Sof okay, but check it
8. Rule of Thumb: Lambda (GHB)
9. Animation over more times than just Stress Periods
10. Focus velocity field, including high DEM contrast!

Movement of interface: hor. of vert.?

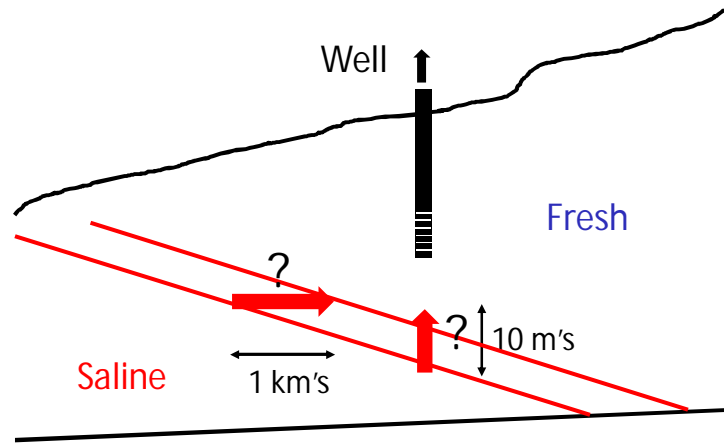

Acknowledge non-stationarity

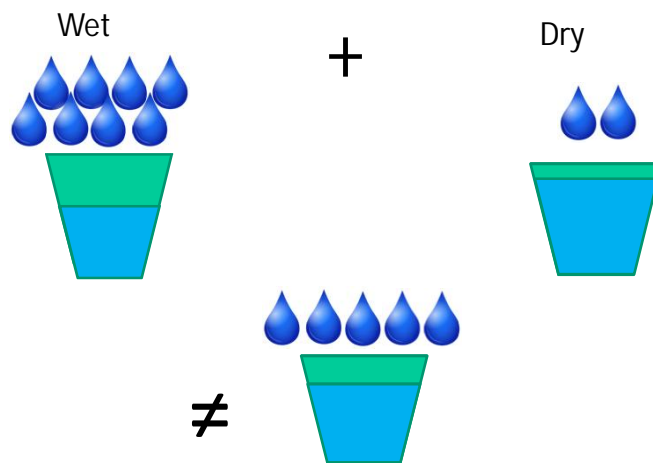

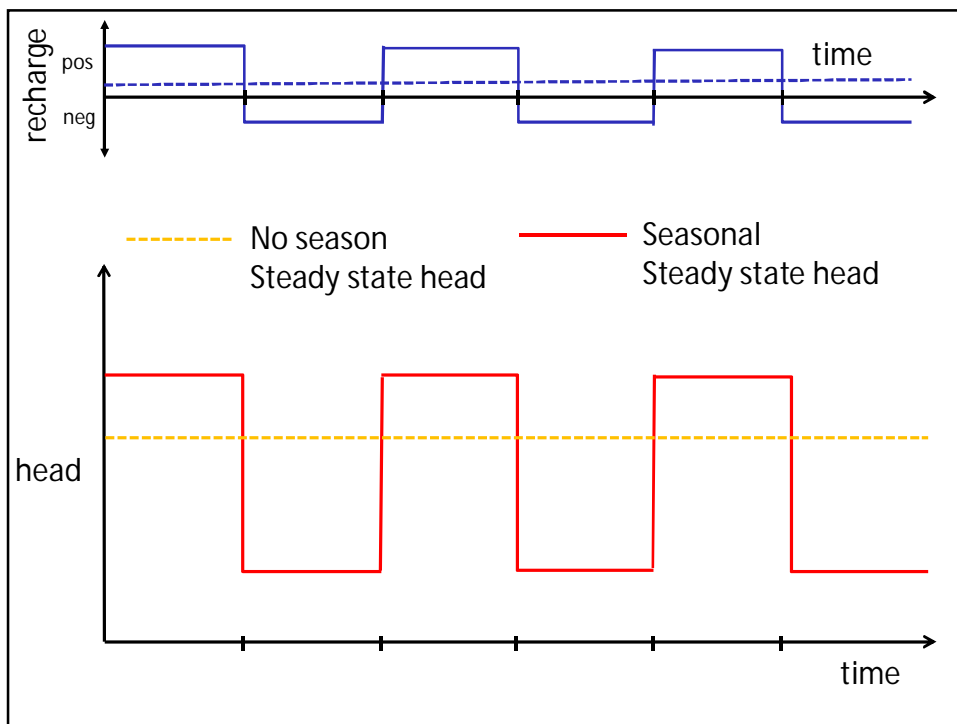
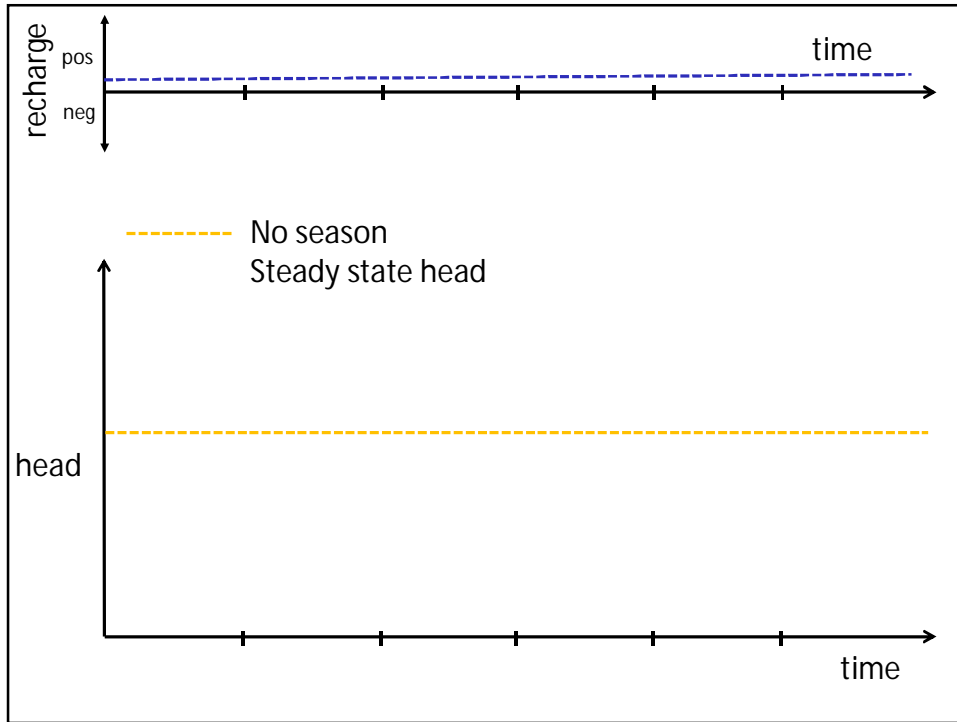

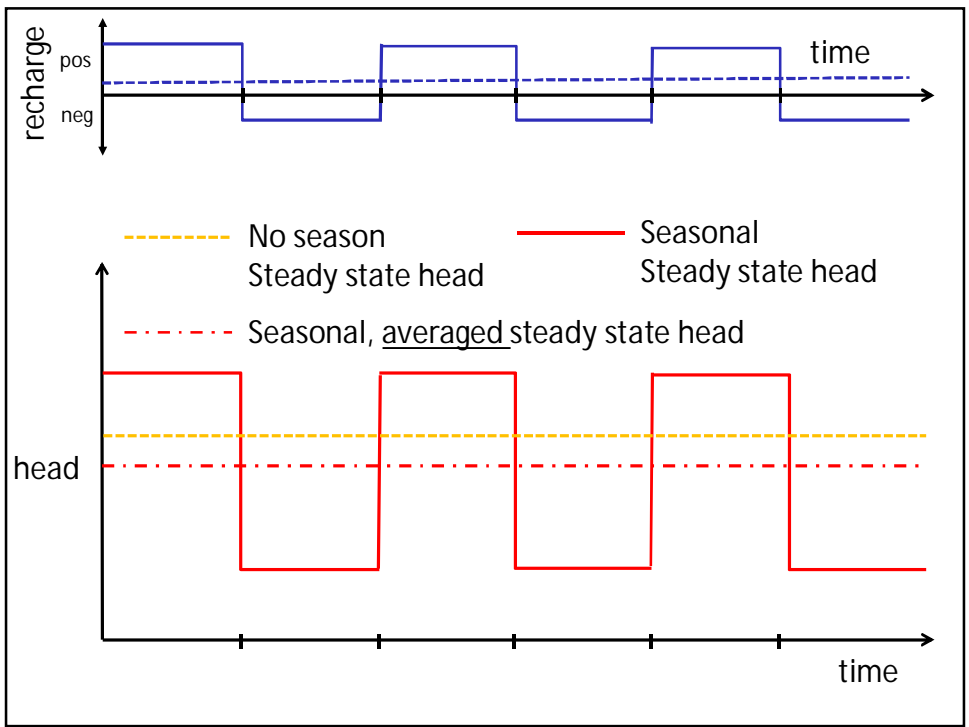
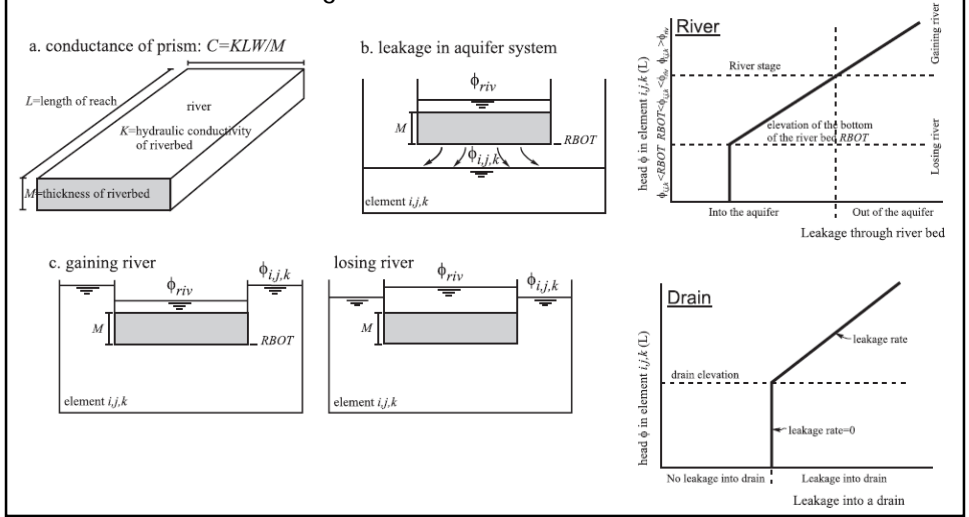

Non-linearity discharge systems, e.g. rivers

During high recharge fluxes, more water is discharged, and head is less high

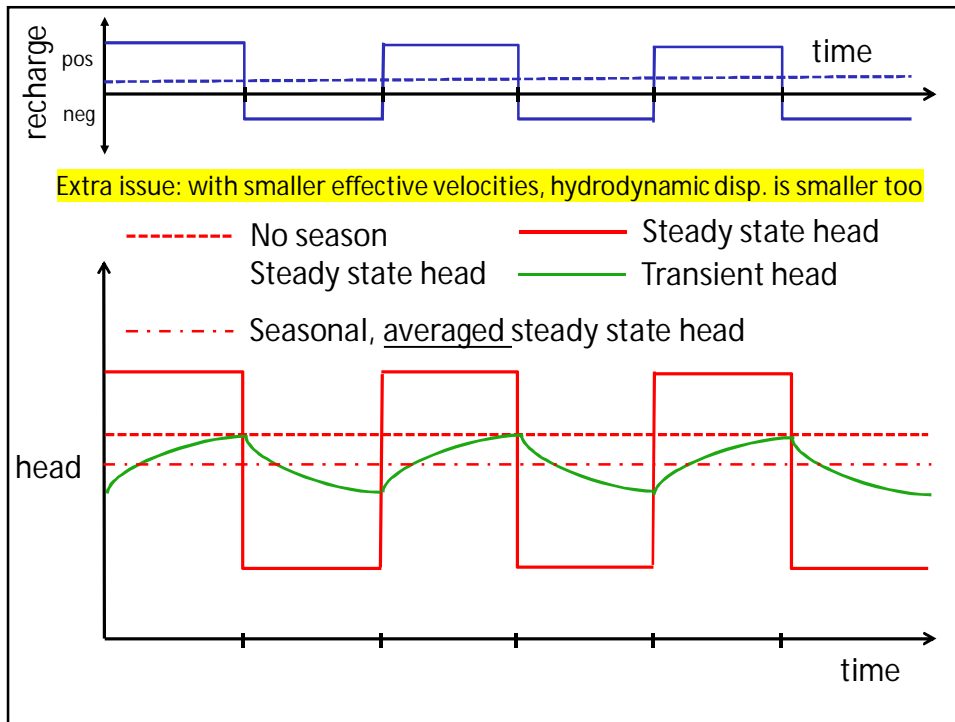



2002



User's Guide to SEAWAT:

A Computer Program For Simulation of Three-Dimensional Variable-Density Ground-Water Flow

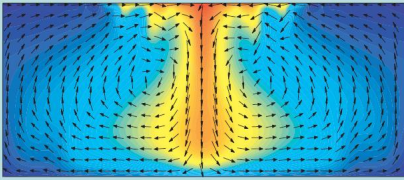

Techniques of Water-Resources Investigations of the U.S. Geological Survey

BOOK 6
Chapter A7

2007/2008



SEAWAT Version 4: A Computer Program for Simulation of Multi-Species Solute and Heat Transport

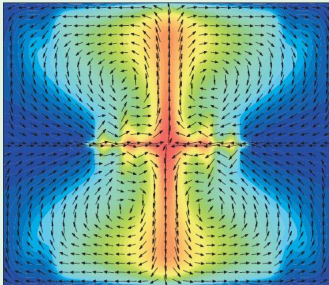

Techniques and Methods Book 6, Chapter A22

U.S. Department of the Interior
U.S. Geological Survey

2002/2003



User's Guide to SEAWAT:
A Computer Program For Simulation of Three-Dimensional Variable-Density Ground-Water Flow

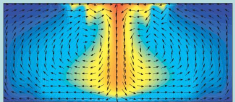

Techniques and Methods Book 6, Chapter A7

MODFLOW-2000, the U.S. Geological Survey Modular Ground-Water Model—Documentation of the SEAWAT-2000 Version with the Variable-Density Flow Process (VDF) and the Integrated MT3DMS Transport Process (IMT)

By Christine E. Langeha, U.S. Geological Survey, Miami, Fla.,
W. Sandy Shoemaker, U.S. Geological Survey, Miami, Fla.,
and Weiqing Guo, CGM, Maitland, FL, Miami, Fla.

U.S. GEOLOGICAL SURVEY
Open-File Report 03-107

Prepared in cooperation with the
U.S. GEOLOGICAL SURVEY OFFICE OF GROUND WATER

2003

2007/2008



SEAWAT Version 4: A Computer Program for Simulation of Multi-Species Solute and Heat Transport

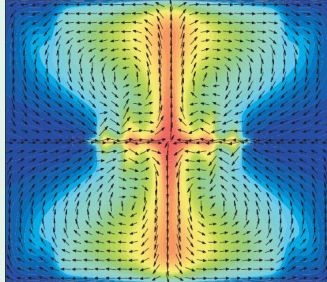

Techniques and Methods Book 6, Chapter A22

U.S. Department of the Interior
U.S. Geological Survey

MT3D 1999

Strategic Environmental Research and Development Program Contract Report SERDP-99-1
December 1999

MT3DMS: A Modular Three-Dimensional Multispecies Transport Model for Simulation of Advection, Dispersion, and Chemical Reactions of Contaminants in Groundwater Systems; Documentation and User's Guide

by Chunmiao Zheng, P. Patrick Wang
Department of Geological Sciences
University of Alabama
Tuscaloosa, AL 35487

Final report
Approved for public release; distribution is unlimited

Prepared for U.S. Army Corps of Engineers
Washington, DC 20314-1000

Under Work Unit No. CU-1062

Monitored by Environmental Laboratory
U.S. Army Engineer Research and Development Center
3909 Halls Ferry Road
Vicksburg, MS 39180-6199

Supplement 2010

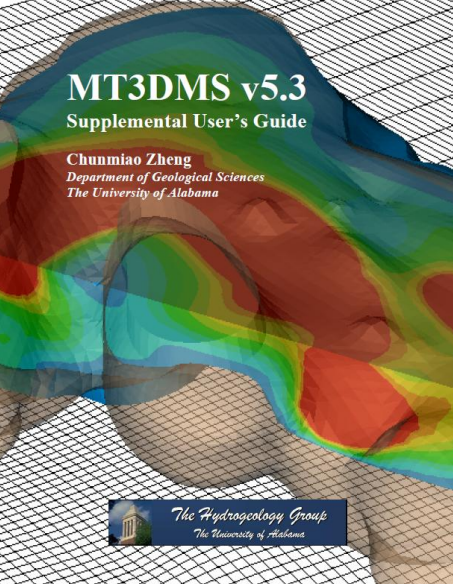

MT3DMS v5.3
Supplemental User's Guide

Chunmiao Zheng
Department of Geological Sciences
The University of Alabama

The Hydrogeology Group
The University of Alabama

Visualisation tools

- Tecplot <https://www.tecplot.com/>
- Paraview <https://www.paraview.org/>
- iMOD <https://oss.deltares.nl/web/imod>
- Flopy <https://www.usgs.gov/software/flopy-python-package-creating-running-and-post-processing-modflow-based-models>
- Modelviewer <https://www.usgs.gov/software/model-viewer-a-program-three-dimensional-visualization-ground-water-model-results>

SEAWAT

$$\nabla \cdot \left[\rho K_o \left(\nabla h_f + \frac{\rho - \rho_f}{\rho_f} \nabla z \right) \right] = \rho S_s \frac{\partial h_f}{\partial t} + \theta \frac{\partial \rho}{\partial C} \frac{\partial C}{\partial t} - \rho_{ss} q_{ss}$$

where ρ is the density of the groundwater ($M L^{-3}$); K_o is the hydraulic conductivity tensor ($L T^{-1}$); h_f is the freshwater head (L); z is the vertical coordinate (L); ρ_f is the density of fresh groundwater ($M L^{-3}$); S_s is the specific storage coefficient (L^{-1}); t is the time (T); θ is the effective porosity (-); C is the concentration ($M L^{-3}$); ρ_{ss} is the density of the sink or source (T^{-1}); and q_{ss} is the sink and source term (T^{-1}).

$$\rho = \rho_f + \frac{\partial \rho}{\partial C} C$$

$$\frac{\partial (\theta C)}{\partial t} = \nabla \cdot (\theta D \cdot \nabla C) - \nabla \cdot (q C) - q_{ss} C_{ss}$$

where D is the hydrodynamic dispersion tensor ($L^2 T^{-1}$); q is the specific discharge vector ($L T^{-1}$) and C_{ss} is the source and sink concentration ($M L^{-3}$).

Restrictions 3D salt water intrusion modelling

- the data problem:
 - not enough hydrogeological data available
 - e.g. the initial density distribution
 - especially important issue in data-poor countries
- the computer problem:
 - modelling transient 3D systems: computer only
 - good enough at high costs
- the numerical dispersion problem:
 - numerical dispersion is large in case of coarse grid

Restrictions 3D salt water intrusion modelling now

- the data problem:
 - not enough hydrogeological data available
 - e.g. the initial density distribution
 - especially important issue in data-poor countries
- the computer problem:
 - modelling transient 3D systems: computer only
 - good enough at high costs
- the numerical dispersion problem:
 - numerical dispersion is large in case of coarse grid

Modelling fresh-salt groundwater on different scales

Sub-local: fingering, salty sand boils
Sri Lanka (Tsunami 2004),
Zandmotor
cell size=1cm-1m

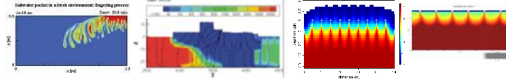

Local: rainwater lenses, heat-cold
Tholen, Schouwen-Duiveland
cell size=5-25m

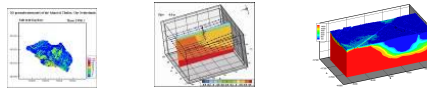

Regional:
Zeeland, Gujarat/India, Philippines
cell size=100m

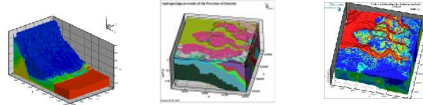

National: salt load
Bangladesh, Zuid-Holland, NHI
cell size=250m-2km

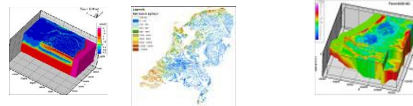

Goal:

To take largest cell size possible to accurately model relevant salinisation processes

Boundary Conditions

Dirichlet: head

- fixed head (DEM minus unsaturated zone)

Neumann: flux

- Zero = no-flow
- Constant

Robin / Cauchy: mixed

- Like General Head Boundary!

Formula of Mazure, zone of influence head

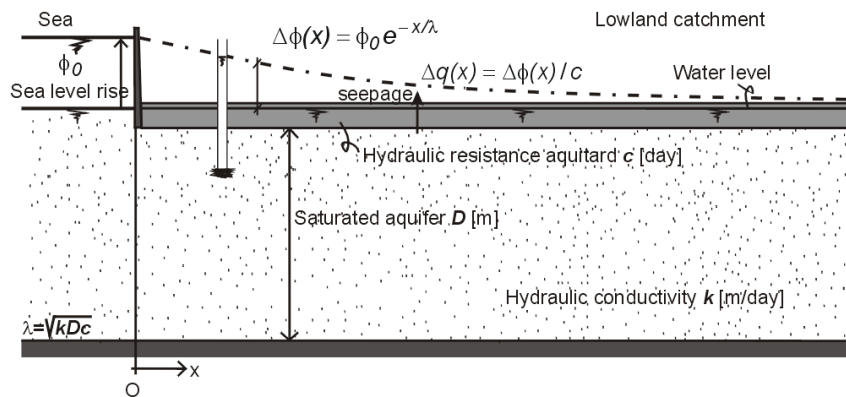

Using the GHB for the head BC

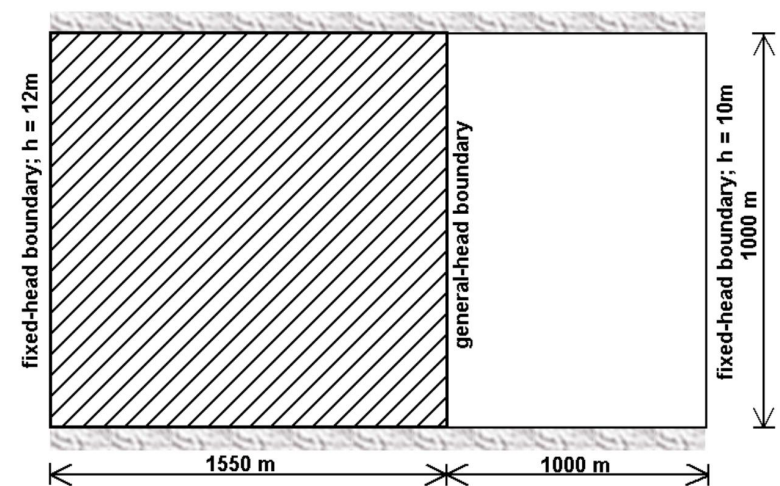

Using the GHB for the head BC

$$\text{Conductance}_{\text{GHB}} = K_{\text{GHB}} \cdot A/L$$

- K_{GHB} is the (horizontal) hydraulic conductivity,
- L is the distance from the actual fixed-head boundary to the modeled GHB cell,
- A is the area of the cell face, which is perpendicular to the groundwater flow in the unmodeled area.

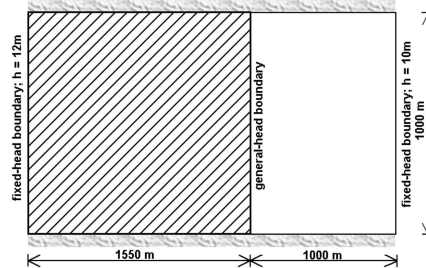

MODFLOW

Boundary conditions in MODFLOW (I)

Example of a system with three types of boundary conditions

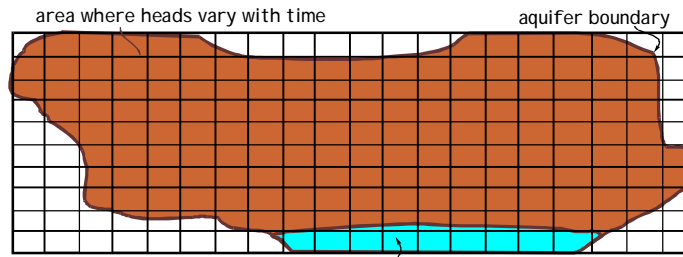

Numeric model

0	1	1	1	1	1	0	0	0	0	0	0	0	1	1	1	1	1	0	0	
1	1	1	1	1	1	1	1	1	1	1	1	1	1	1	1	1	1	1	1	0
1	1	1	1	1	1	1	1	1	1	1	1	1	1	1	1	1	1	1	0	
0	1	1	1	1	1	1	1	1	1	1	1	1	1	1	1	1	1	1	0	
0	0	1	1	1	1	1	1	1	1	1	1	1	1	1	1	1	1	1	0	
0	0	1	1	1	1	1	1	1	1	1	1	1	1	1	1	1	1	1	1	
0	0	1	1	1	1	1	1	1	1	1	1	1	1	1	1	1	1	1	1	
0	0	1	1	1	1	1	1	1	1	1	1	1	1	1	1	1	1	1	0	
0	0	0	0	0	0	1	1	1	1	1	1	1	1	1	1	1	1	1	0	
0	0	0	0	0	0	0	-1	-1	-1	-1	-1	-1	-1	-1	-1	-1	0	0	0	

Boundary conditions in MODFLOW (II)

- For a constant head condition: IBOUND<0
- For a no flow condition: IBOUND=0
- For a variable head: IBOUND>0

Packages in MODFLOW

1. Well package
2. River package
3. Recharge package
4. Drain package
5. Evaporation package
6. General head package

1. Well package

$$Q_{well} = Q_{i,j,k}$$

Example: an extraction of 10 m³ per day should be inserted
in an element as:

$$Q_{ext,i,j,k} = P_{i,j,k} \phi_{i,j,k}^{t+\Delta t} + Q'_{i,j,k}$$

$$Q_{ext,i,j,k} = -10 \quad (\text{in} = \text{positive})$$

$$Q'_{i,j,k} = -10$$

2. River package (I)

river loses water

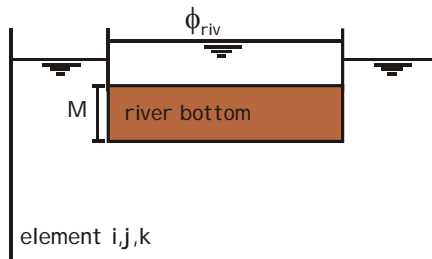

river gains water

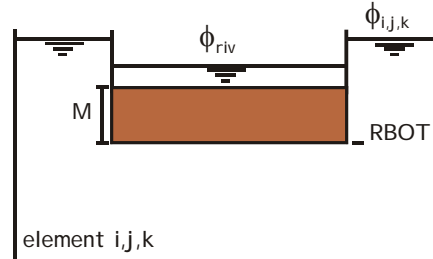

$$Q_{riv} = KLW \left(\frac{\phi_{riv} - \phi_{i,j,k}}{M} \right)$$

$$Q_{riv} = \frac{KLW}{M} (\phi_{riv} - \phi_{i,j,k}) \Leftrightarrow Q_{riv} = C_{riv} (\phi_{riv} - \phi_{i,j,k})$$

2. River package (II)

$$Q_{riv} = C_{riv} (\phi_{riv} - \phi_{i,j,k})$$

Example: the river conductance C_{riv} is 20 m²/day and the river level=3 m, than this package should be inserted in an element as:

$$Q_{ext,i,j,k} = P_{i,j,k} \phi_{i,j,k}^{t+\Delta t} + Q'_{i,j,k}$$

$$Q_{ext,i,j,k} = 20(3 - \phi_{i,j,k})$$

$$Q'_{i,j,k} = 60 \quad \text{and} \quad P_{i,j,k} = -20$$

2. River package (III)

Determine the conductance of the river in one element:

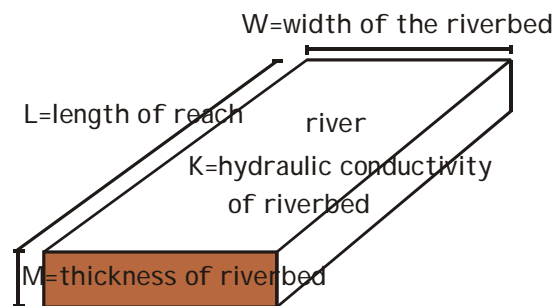

where $C_{riv} = \frac{KLW}{M}$ is the
conductance [L^2/T] of the river

CONDUCTANCE

conductance of prism: $C = KLW/M$

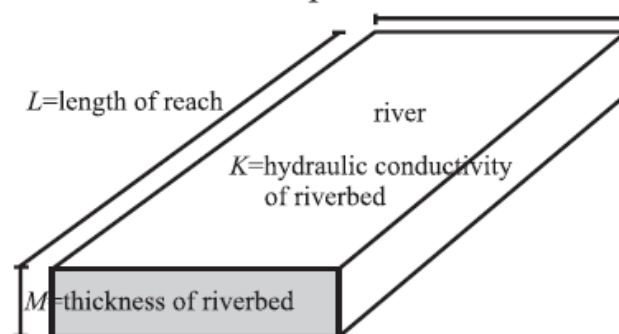

River Package: water courses

1. Location of watercourses
2. Water level; different approach per type of watercourse
3. Drainage resistance (conductance)
4. Chloride concentration surface water

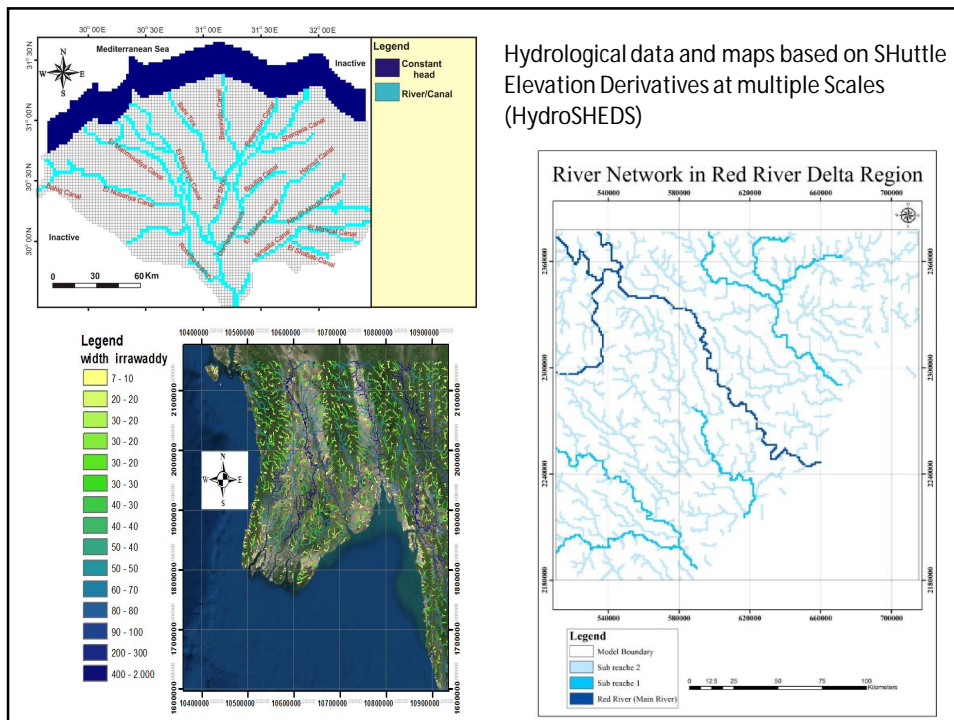

River types, model Zeeland

Watercourse type	Type	Indeling Waterboard
1	<i>Sloot</i> =ditch (top10)	Primaire waterloop / secundaire waterloop
2	<i>Rivier</i> =river (top10)	Primaire waterloop
3	<i>Meer</i> =lake (top10)	
4	<i>Kanaal</i> =canal (top10)	
5	<i>Greppel</i> =trench (top10)	Secundaire waterloop/ tertiare waterloop
6	<i>Zee</i> =sea or <i>binnenwater</i> =innersea	

River types, model Zeeland

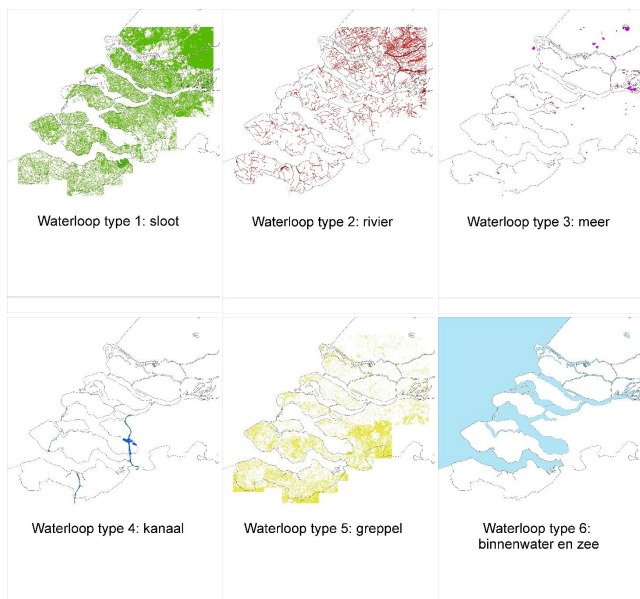

2. River package (IV)
Leakage to the groundwater system

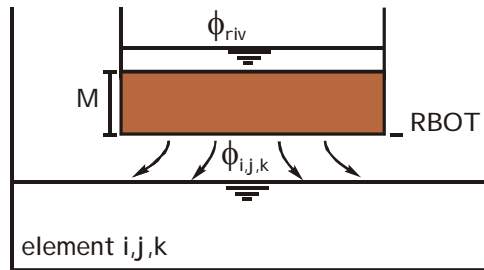

Special case:

if $\phi_{i,j,k} < RBOT$, then $Q_{riv} = C_{riv} (\phi_{riv} - RBOT)$

2. River package (V)

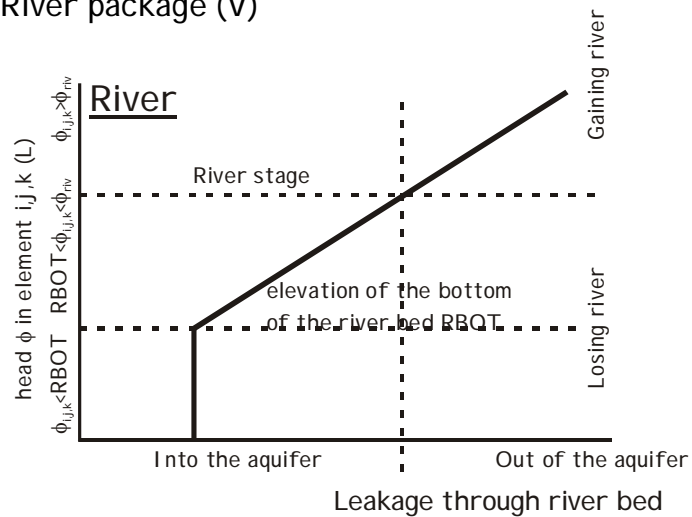

3. Recharge package

$$Q_{rec} = I\Delta x\Delta y$$

4. Drain package

$$Q_{dm} = C_{dm}(\phi_{i,j,k} - d)$$

Special case:

if $\phi_{i,j,k} < d$ then $Q_{dm} = 0$

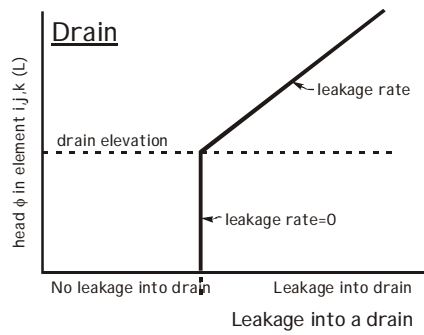
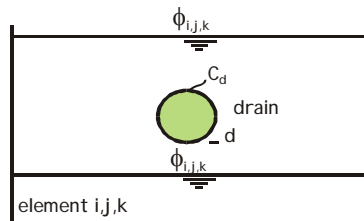

5. Evapotranspiration package

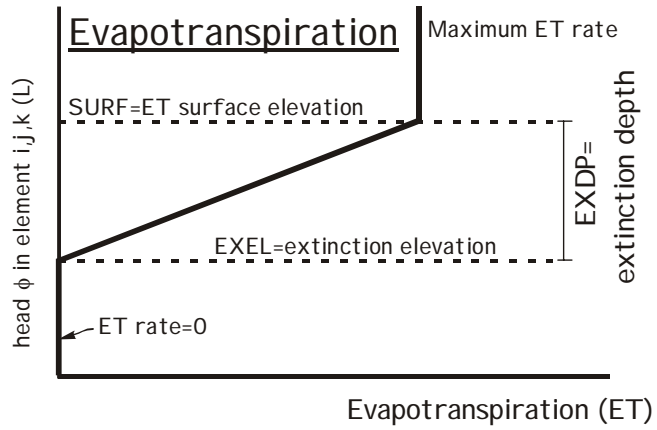

6. General head boundary package

$$Q_{ghb} = C_{ghb} (\phi_{ghb} - \phi_{i,j,k})$$

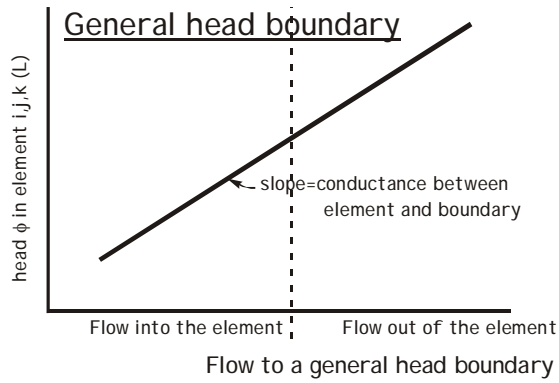
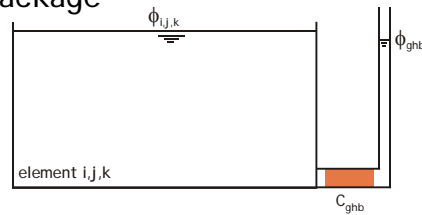

Time indication MODFLOW

I TMUNI =1: seconde
 I TMUNI =2: minute
 I TMUNI =3: hour
 I TMUNI =4: day
 I TMUNI =5: year

Flow time step and solute time step

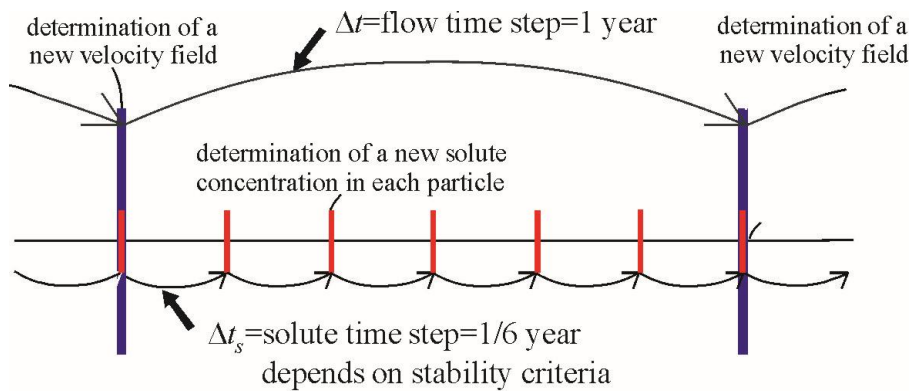

- * velocity field remains constant during 1 year
- * solute concentration changes during each solute time step

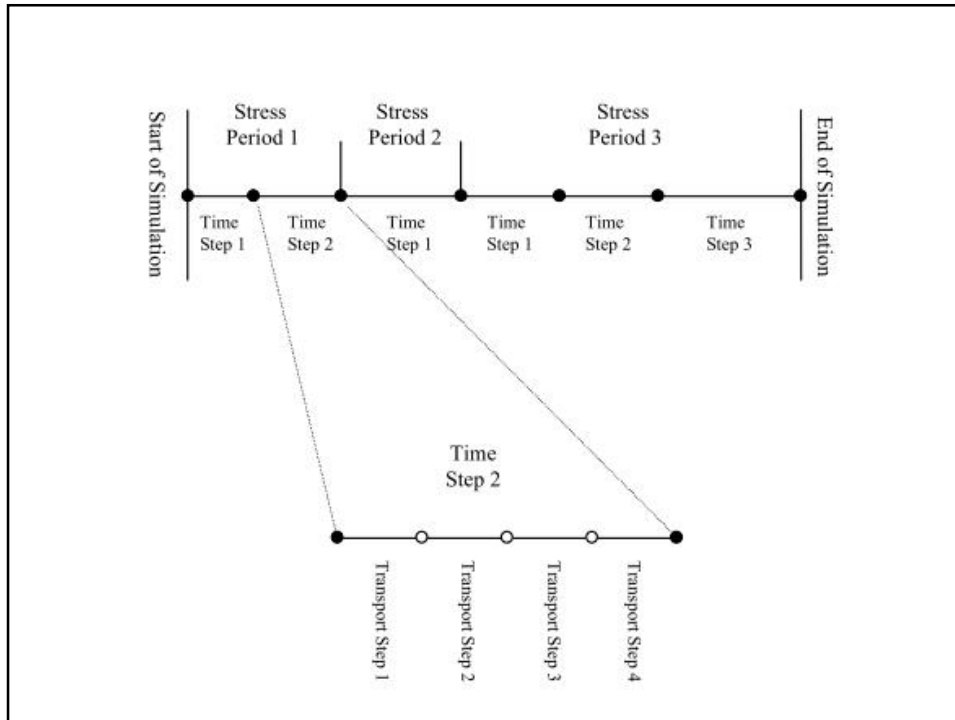

variable density

Stability criteria for solute transport equation (I)

1. Neumann criterion:

$$\frac{D_{xx}\Delta t_s}{\Delta x^2} + \frac{D_{yy}\Delta t_s}{\Delta y^2} + \frac{D_{zz}\Delta t_s}{\Delta z^2} \leq 0.5$$

$$\Delta t_s \leq \frac{0.5}{\frac{D_{xx}}{\Delta x^2} + \frac{D_{yy}}{\Delta y^2} + \frac{D_{zz}}{\Delta z^2}}$$

Stability criteria for solute transport equation (II)

2. Mixing criterion:

$$\Delta t_s \leq \frac{n_e b_{i,j,k}^k}{Q'_{i,j,k}}$$

Change in concentration in element is not allowed to be larger than the difference between the present concentration in the element and the concentration in the source

Stability criteria for solute transport equation (III)

3. Courant criterion:

$$0 < \xi \leq 1$$

$$\Delta t_s \leq \frac{\xi \Delta x}{V_{x,\max}} \quad \Delta t_s \leq \frac{\xi \Delta y}{V_{y,\max}} \quad \Delta t_s \leq \frac{\xi \Delta z}{V_{z,\max}}$$

Stability criteria (III)

3. Courant criterium

- * Node element
- Particle
- Velocity direction
- Movement particles

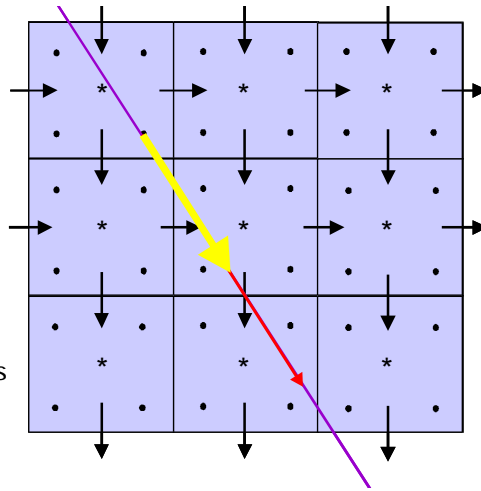

$$0 < x \leq 1$$

$$\Delta t_s \leq \frac{\xi \Delta x}{V_{x,\max}}$$

$$\Delta t_s \leq \frac{\xi \Delta y}{V_{y,\max}}$$

$$\Delta t_s \leq \frac{\xi \Delta z}{V_{z,\max}}$$

Courant criterion: places where timestep is smaller than 40 days

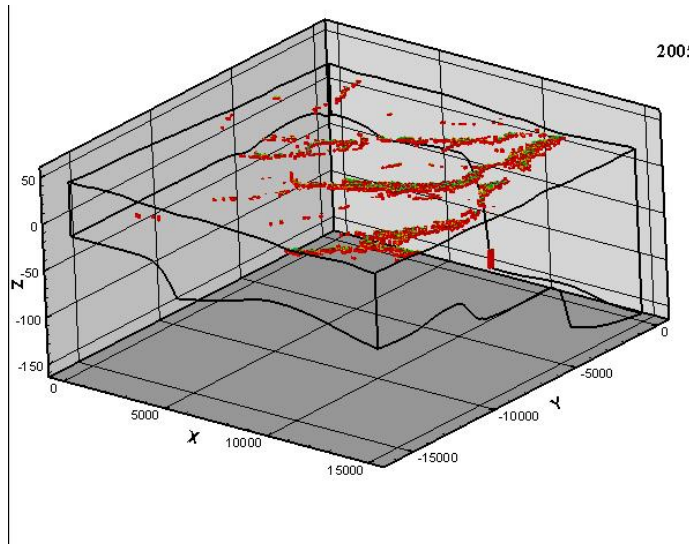

Check the velocity field!

Tool: tecplot / paraview

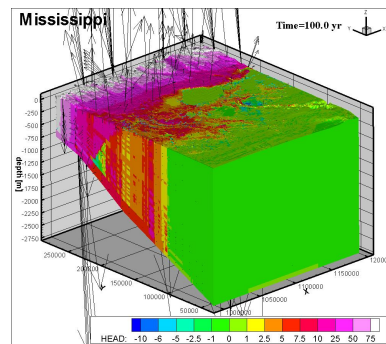
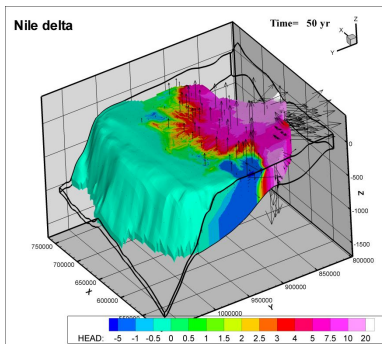
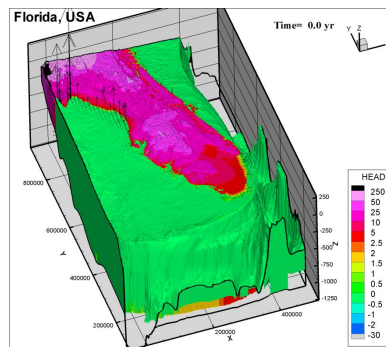

Case Nippon Koei:

parallel version

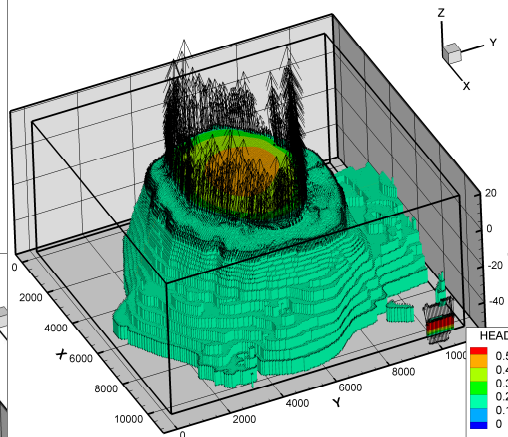
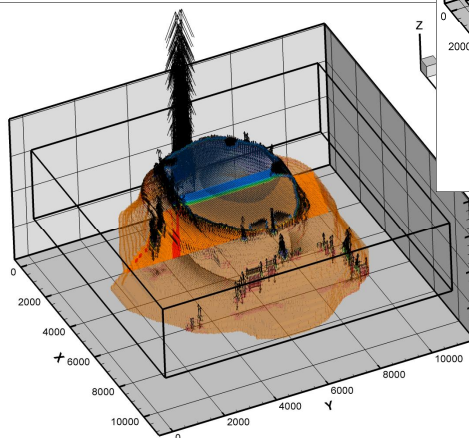

Case Nippon Koei: parallel version

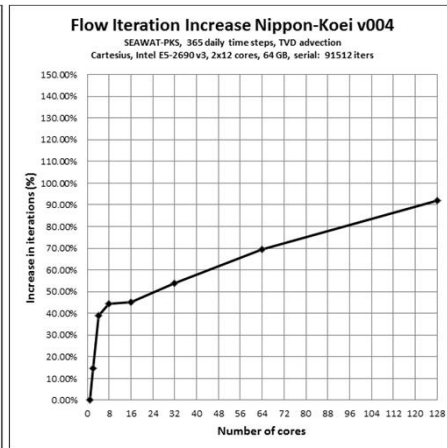
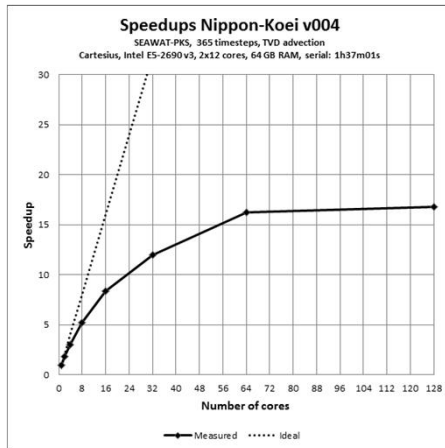
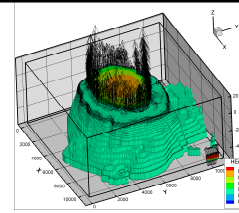

Case Nippon Koei: parallel version

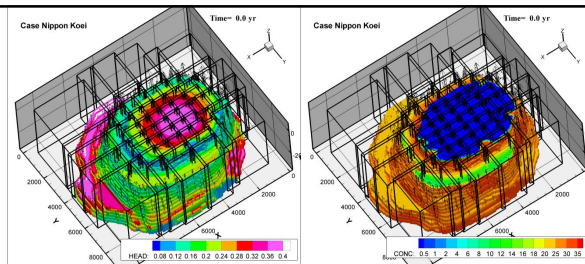

Name	seawat005_gv23	seawat006_gv23	seawat-3-004	seawat-3-004	seawat-3-004
parallel	no	no	no	yes	yes
name 'nam' file	gv23	gv23	gv23	gv23	gv23
software	SEAWAT	SEAWAT	SEAWAT	iMOD-SEAWAT	iMOD-SEAWAT
computer	Quad 2.60 GHz	Quad 2.60 GHz	Quad 2.60 GHz	Cartesius 1 core	Cartesius 64 cores
date input data	21-11-17	08-12-17	21-12-2017	21-12-2017	21-12-2017
calc_time	5d0h36m43s	0d10h25m52s	0d6h41m14s	-0d1h30m0s	0d0h5m59s
speedup factor	1	12.0	18.0	44.0	1209.5

hclose, rclose (Nile Delta model)

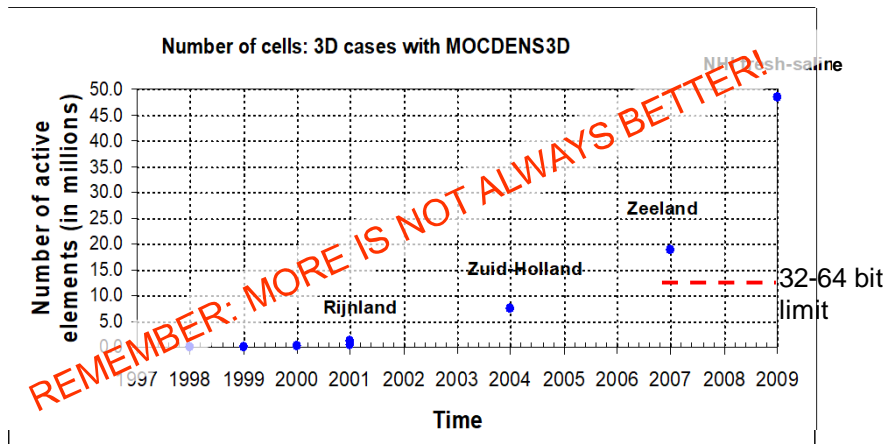
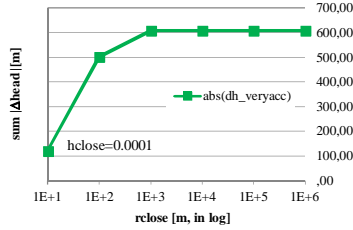
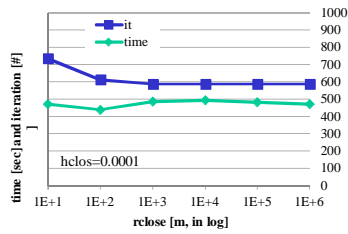
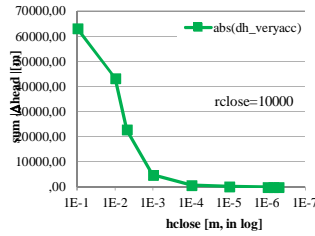
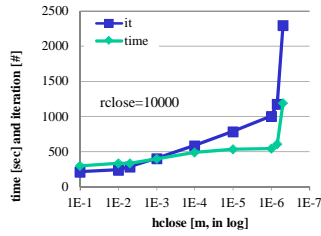
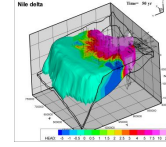

DO NOT DO THIS AT HOME (IF YOU HAVE NOT ENOUGH DATA)

Modelling effect climate change on fresh-salt groundwater

Modelling:

- variable-density
- 3D, non-steady
- groundwater flow
- coupled solute transport

Code:

MOCDENS3D (MODFLOW family)
similar to SEAWAT

Assessing effects:

- autonomous salinisation
- sea level rise
- changing recharge pattern
- land subsidence
- changing extraction rates
- adaption measures

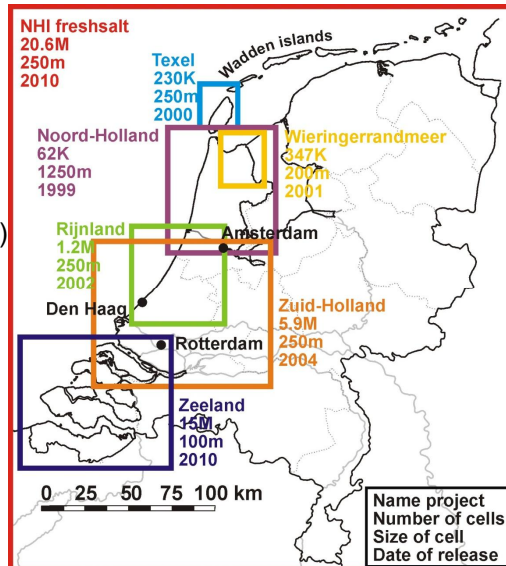

Fields of application of fresh-saline groundwater models

- Water system analysis in brackish-saline environments (salt loads, salt boils, freshwater lenses)
- Quantifying effects of climate change & sea level rise
- Drinking water issues: upconing saline groundwater under extraction wells
- Developing measurements to stop salinization groundwater systems (e.g. fresh keeper, coastal collectors, freshwater storage underground)
- Impact of the disasters as tsunamis on fresh groundwater resources
- Submarine Groundwater Discharge (marine water pollution, Harmful Algae)

Difficulties with variable density groundwater flow

- Initial density distribution (effects on velocity field) !
- Velocities freshwater lens at the outflow face near the sea
- Boundary conditions (especially concentration boundaries)
- Choice of element size
- Length of flow time step to recalculate groundwater flow

Outflow face at the coast is difficult to model

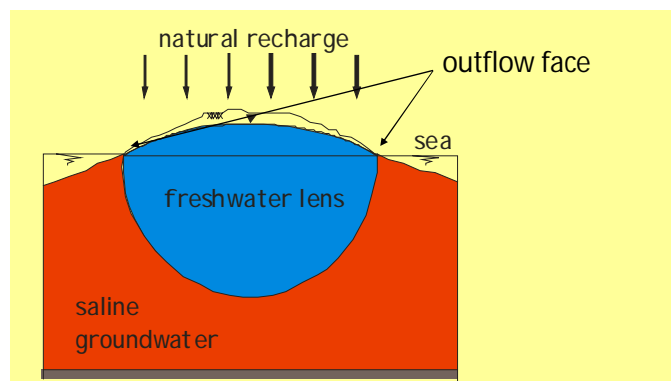

Flow converges and thus velocities are very high at the outflow face

This is numerically difficult to handle

A good initial density distribution is essential

- Because groundwater and solute transport are coupled, the density influences groundwater velocities
- Numerous density measurements are necessary to get a reliable 3D density matrix

'Procedure' to improve initial density distribution

- Implement all chloride data
 - Analyses, Borehole, VES, Airborne techniques (HEM, SkyTem)
 - Better old than nothing
 - Better VES than nothing
- Interpolate and extrapolate
 - Sea = easy (salt)
 - Inland = fresh?
- Start with simulation (10/20/30 years) with mol.diffusion*1000 to smooth out artificial densities

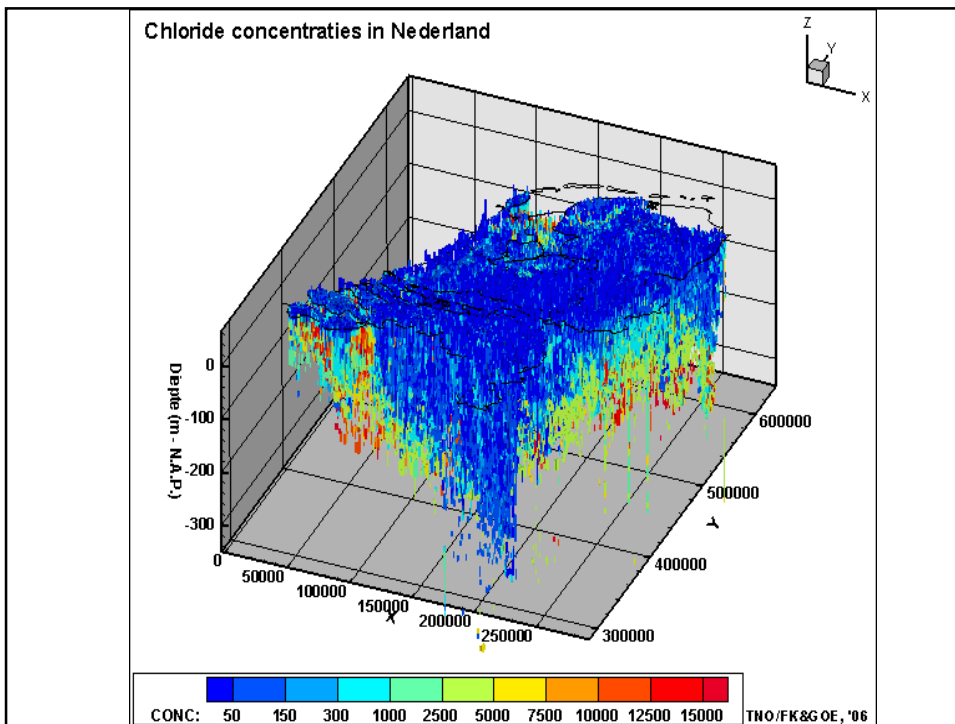
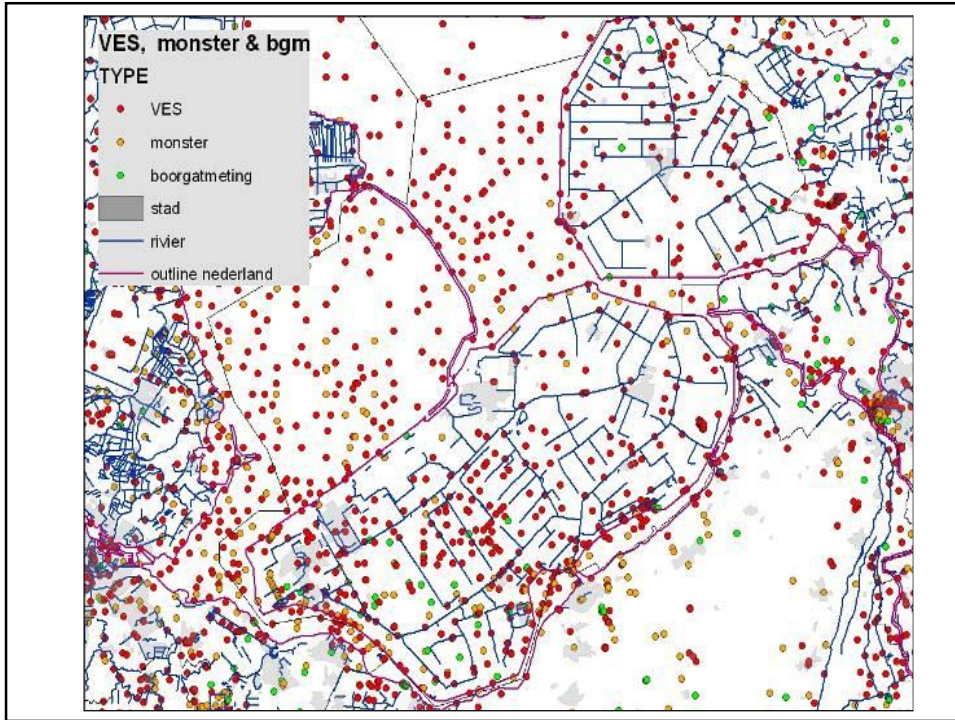

Mapping brackish-saline interface Zeeland

Combining different types of data sources:

Data type	Characteristics of measurement	# Data	Determined	Accuracy depth of interfaces
Groundwater Samples	0D in situ	721	Chloride concentration	Depends on positions of screens
Geo-electrical borehole logs	1D in situ	149	1D chloride profile, Depth fresh-brackish and brackish-saline interface, Inversions.	±1 m
Electrical CPT	1D in situ (max. depth 50 m)	71	Borehole log	±1 m
VES	1D from surface	1113	Depth brackish-saline interface, Major inversions, (1D chloride profile).	±20% of depth
EM34	1D from surface	3251	Depth brackish-saline interface	ranges of 7.5, 15 or 30 m (accuracy decreases with depth)
Groundwater Abstractions	0D in situ	716	Depth brackish-saline interface	a range depending on screen depth
Unique locations		6021		

Mapping brackish-saline interface

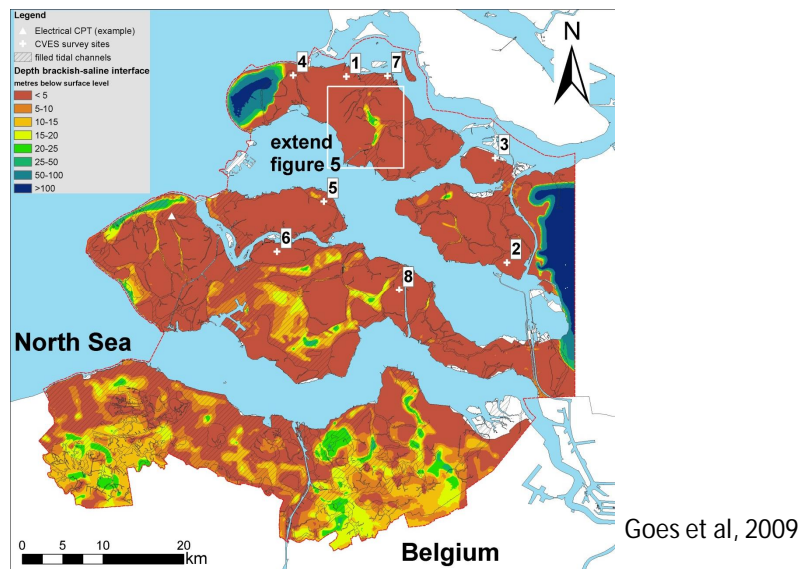

Mapping brackish-saline interface

Combining different types of data sources

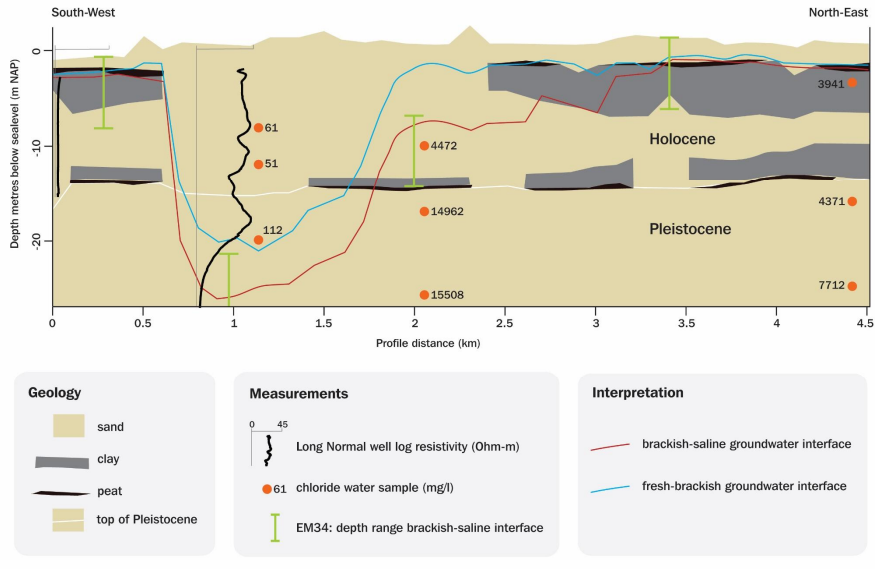

Use variable-density groundwater flow modelling

Why a model?

- variation in ground surface directly affects fresh-saline distribution

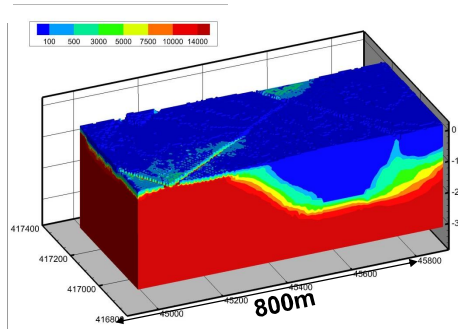
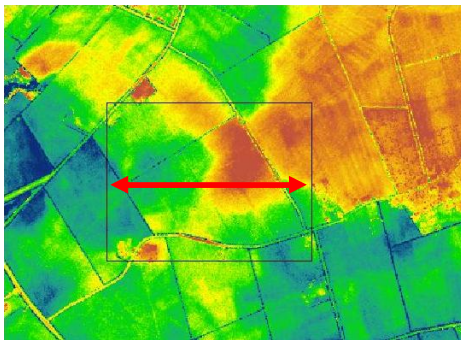

Use variable-density groundwater flow modelling

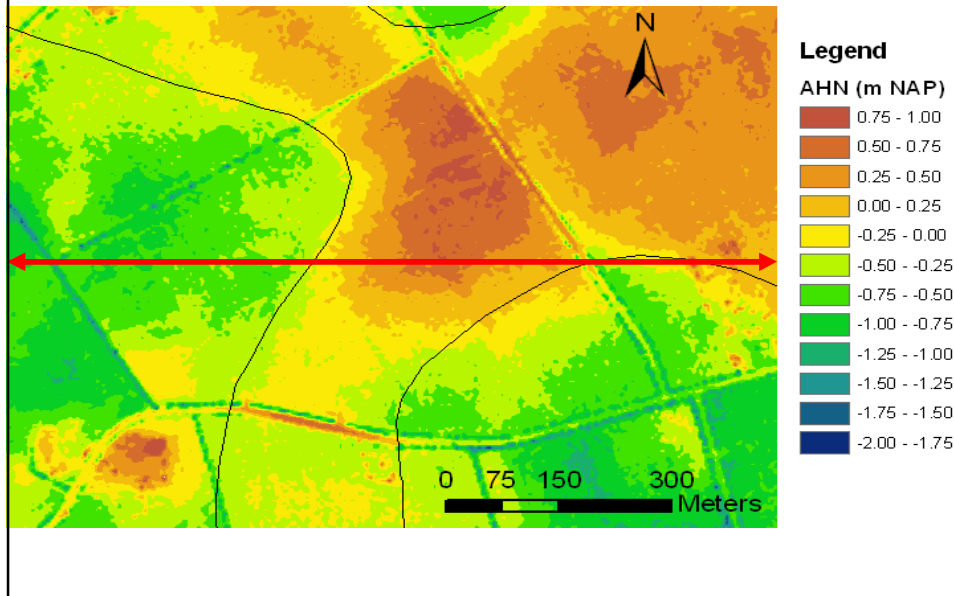

Local 3D model of the agricultural plot

Modelling:

- variable-density
- 3D, non-steady
- groundwater flow & coupled solute transport
- model cell size: 5*5m²

Code:

MOCDENS3D

Assessing effects:

- autonomous salinisation
- sea level rise
- changing recharge pattern
- (adaption measures)

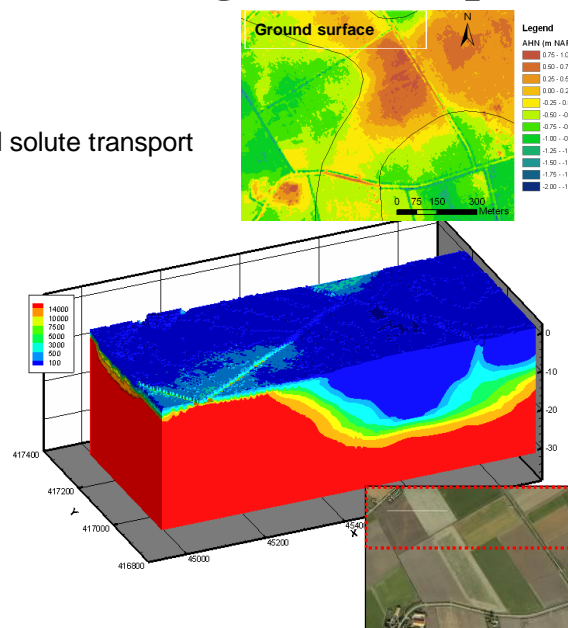

Local approach: simulated Cl-conc. with different CC-scenarios

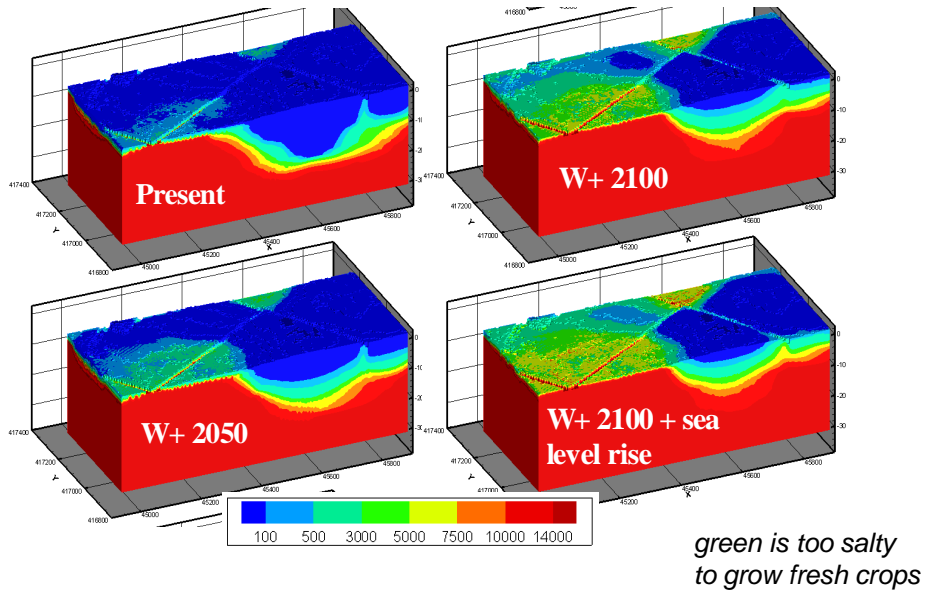

Use variable-density groundwater flow modelling

Why a model?

- variation in ground surface directly affects fresh-saline distribution

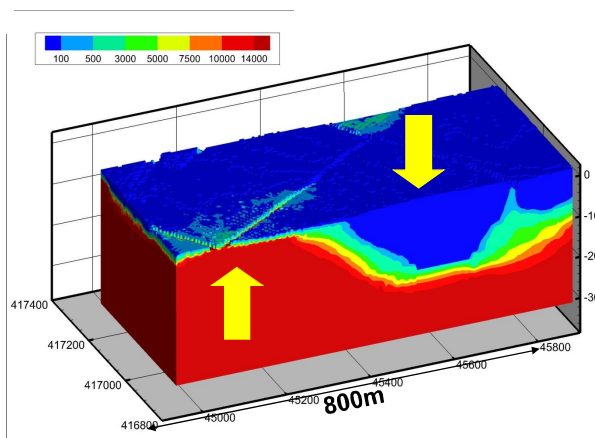
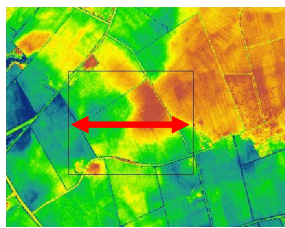

Interpolation chloride

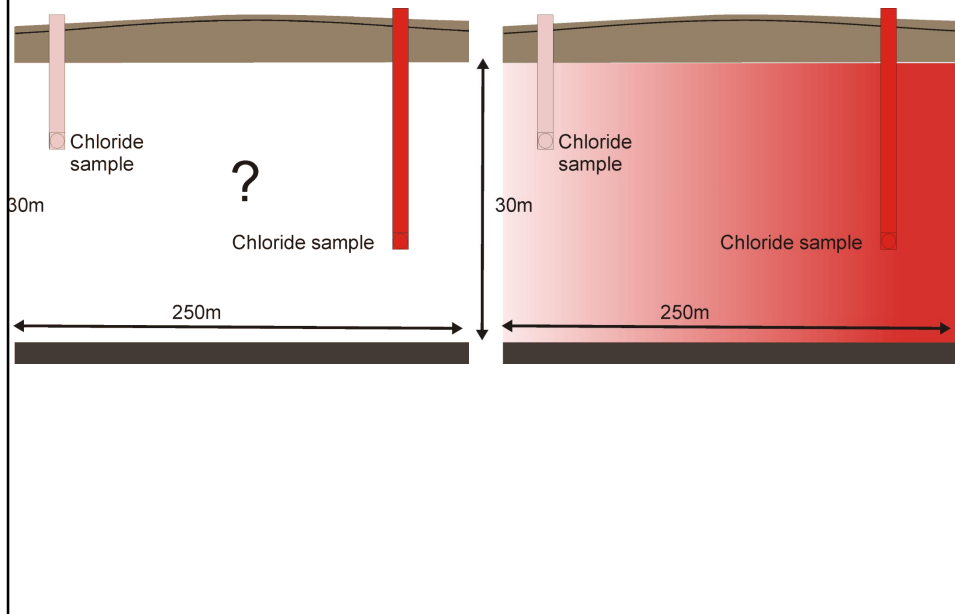

Using flow model for better interpolate chloride

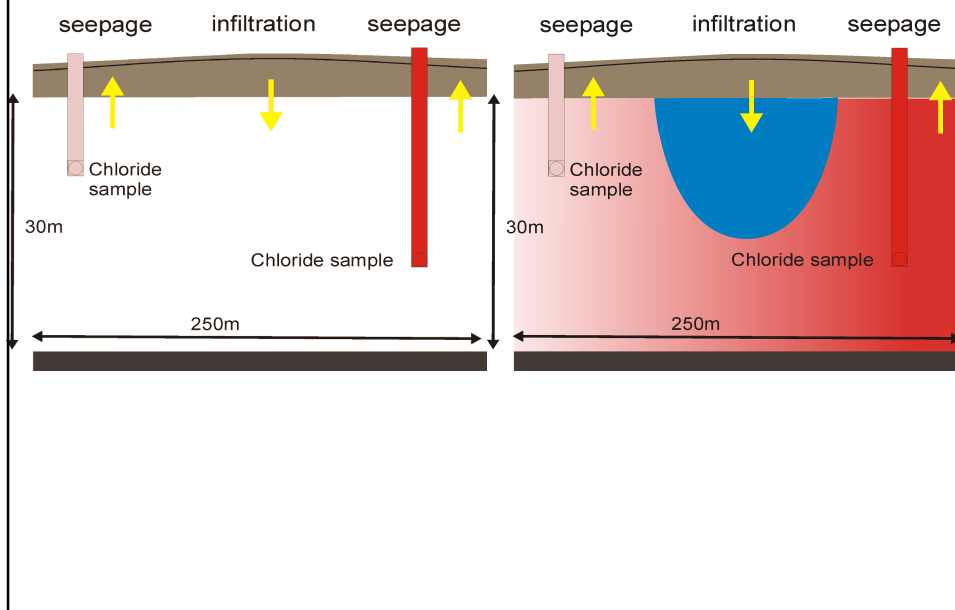

3D fresh-saline groundwater distribution

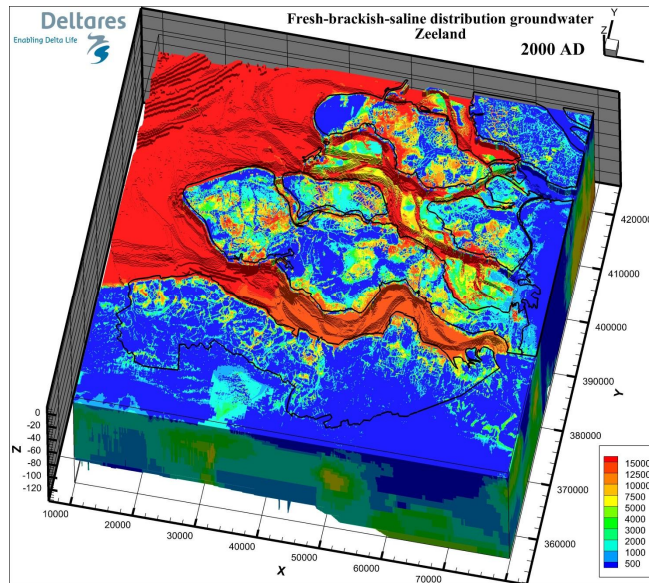

Regional groundwater model: From chloride measurements to a 3D distribution

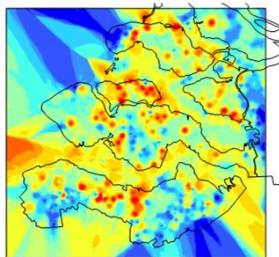
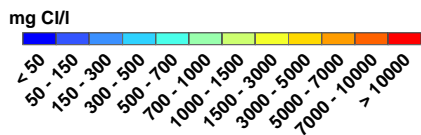

- Step 1:**
interpolating data:
- Groundwater samples
 - Geo-electrical borehole logs
 - (C)VES, EM, electrical CPT

EWRMP 201511

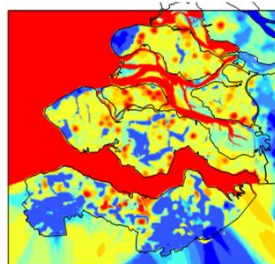

- Step 2:**
including interfaces
- Mapped fresh-brackish
 - Mapped brackish-salt

results at - 6.5 m msl

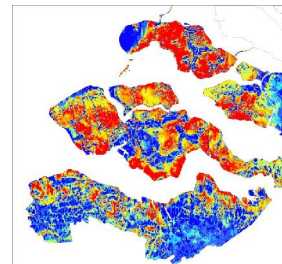

- Step 3:**
model result 2010:
- Model as interpolator

Examples of variable-density groundwater flow

- Rotating immiscible interface
- Henry's problem
- Evolution freshwater lens
- Hydrocoin
- Salt water pocket
- Broad 14 Basin, North Sea
- Heat transport: Elder and Rayleigh=4000
- 5 Dutch 3D cases
- Freshwater lenses
- Effect of Tsunami on groundwater resources

Case Nile delta, effect of solvers

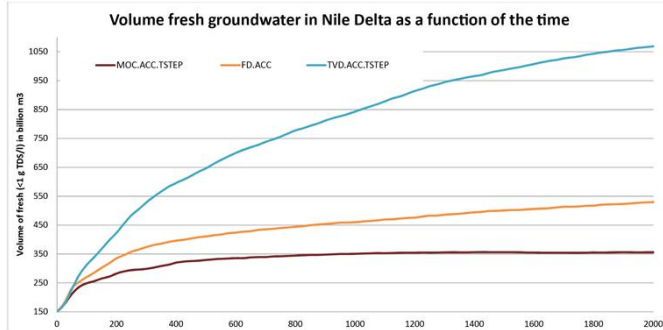

MOC.ACC.TSTEP

FD.ACC

TVD.ACC.TSTEP

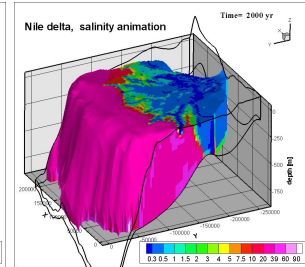
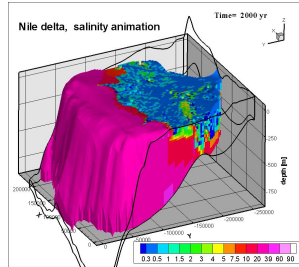
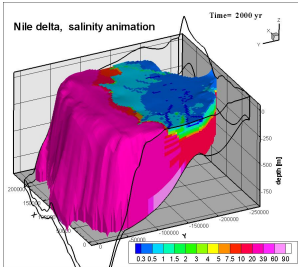

MOC.ACC.TSTEP

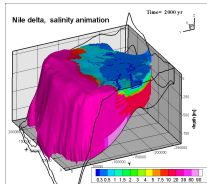

TVD.ACC.TSTEP

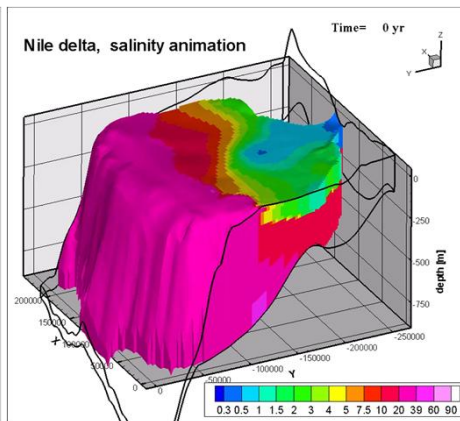
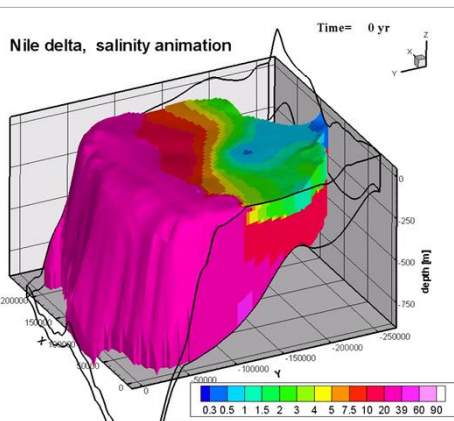
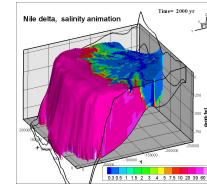

Case Nile delta, effect of solvers, and different settings (e.g. Courant number, number of time steps, SS/TR)

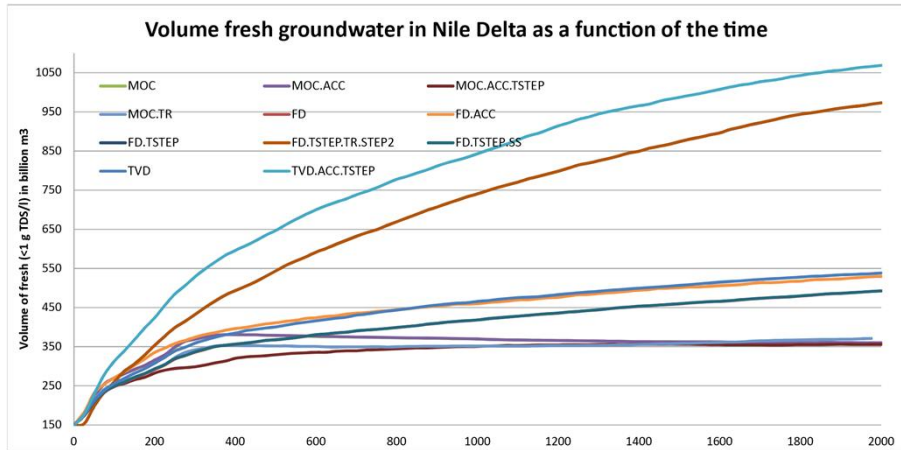

Find the two errors!

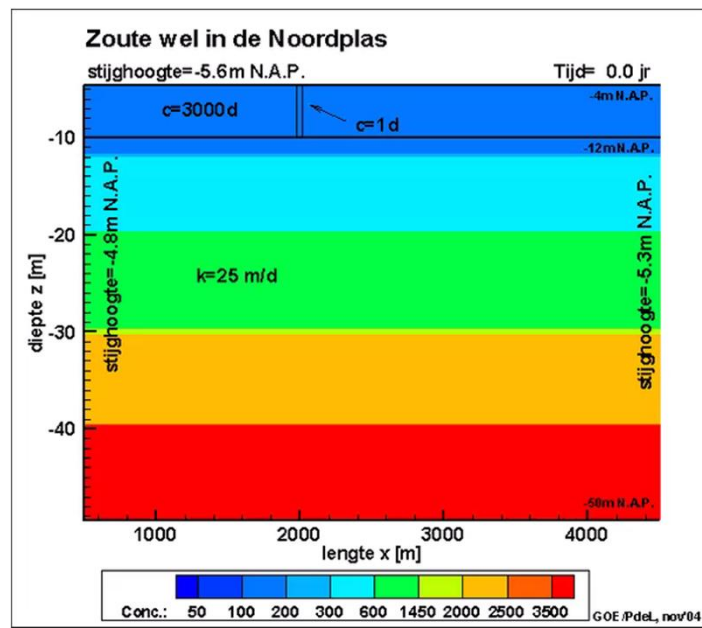

Salt water pocket in a fresh environment

Grid convergence

Time step

Salt water pocket in a fresh environment (I)

cases

Effect of discretisation on a 'salt lake problem'

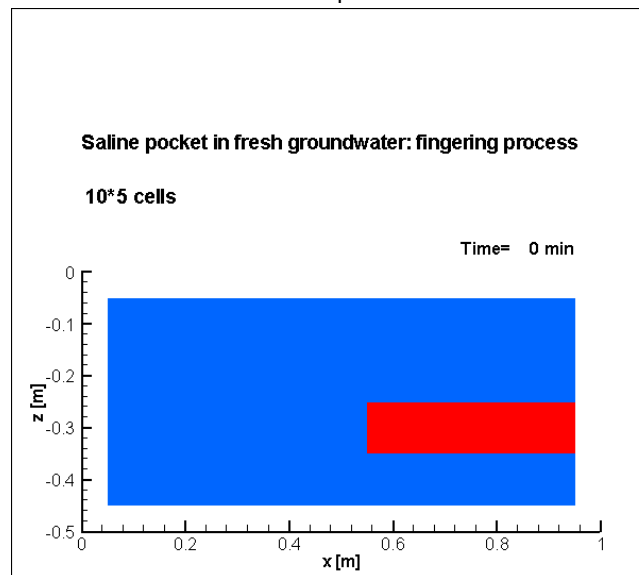

Salt water pocket in a fresh environment (I)

Effect of discretisation on a 'salt lake problem'

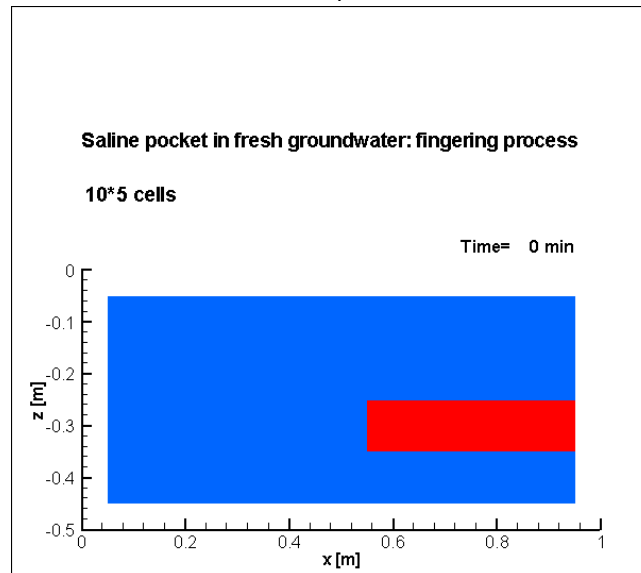

Salt water pocket in a fresh environment (II)

Effect of discretisation

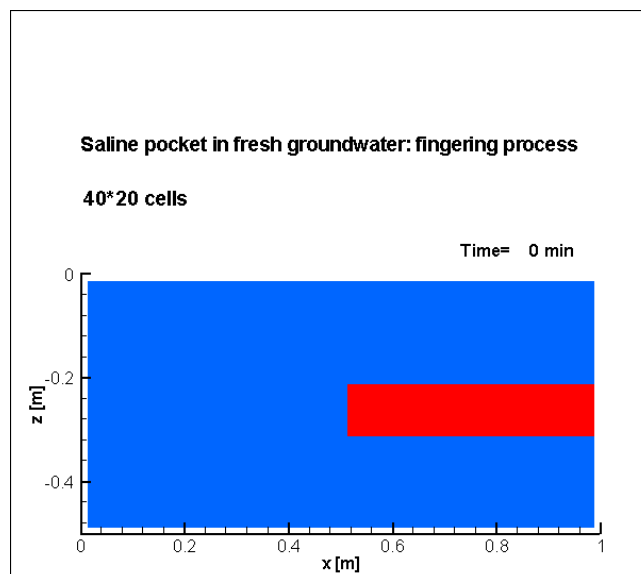

Salt water pocket in a fresh environment (II)

Effect of discretisation

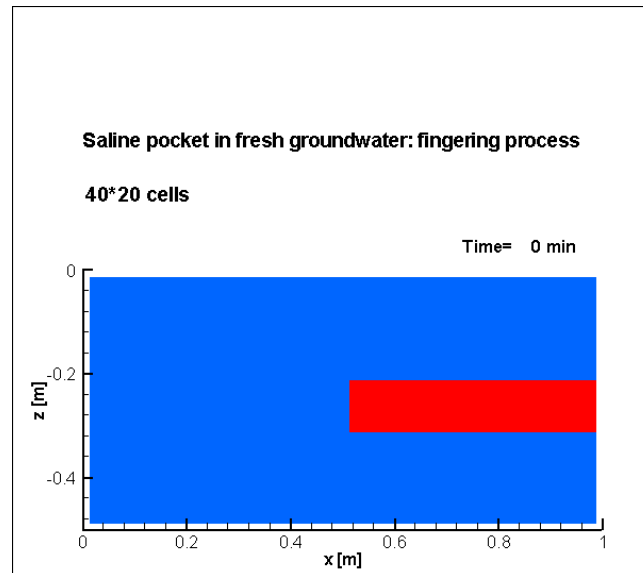

Salt water pocket in a fresh environment (III)

Effect of discretisation

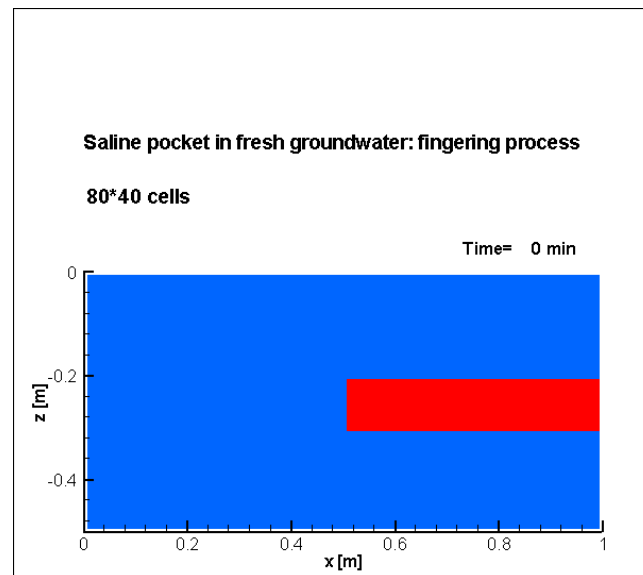

Salt water pocket in a fresh environment (III)

Effect of discretisation

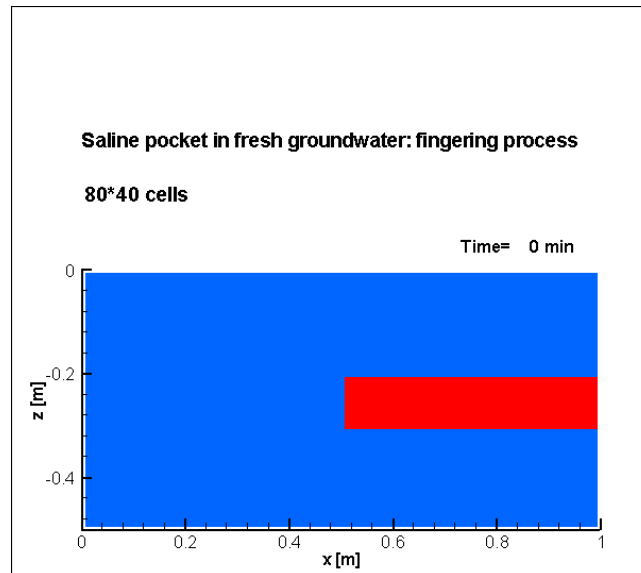

Salt water pocket in a fresh environment (IV)

Effect of discretisation

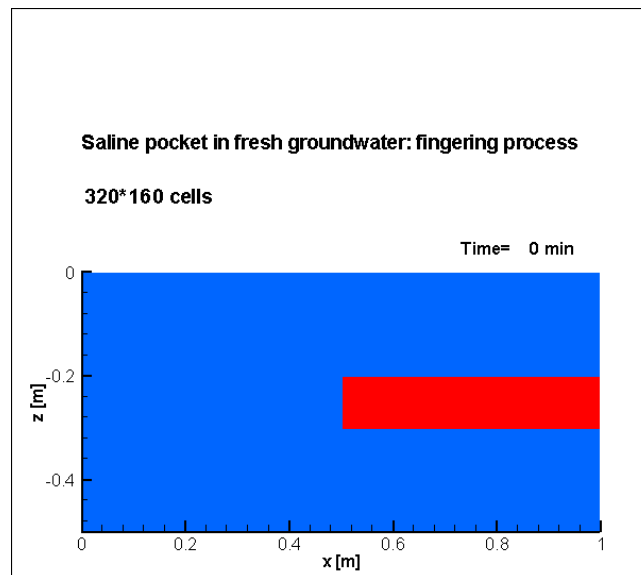

Salt water pocket in a fresh environment (IV)

Effect of discretisation

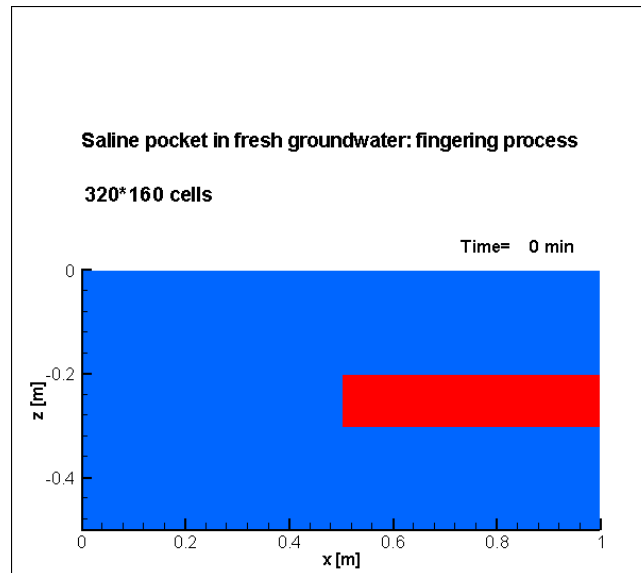

Salt water pocket in a fresh environment (V)

Effect of discretisation

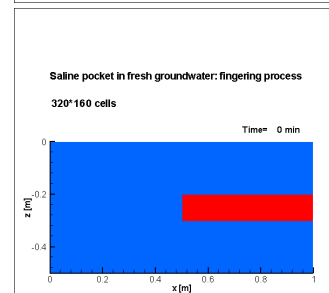
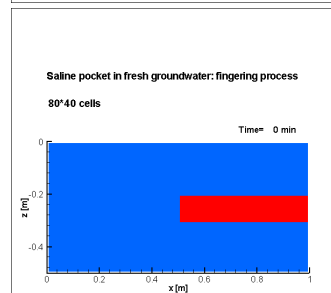
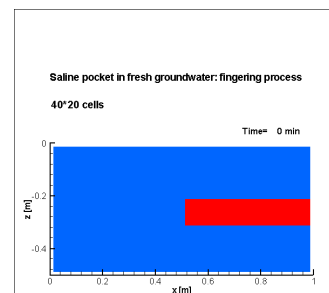
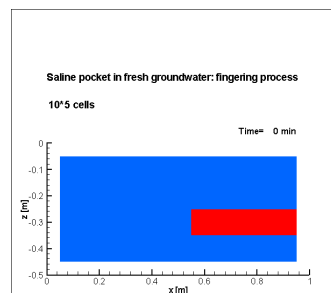

Effect of size model cell on physical process

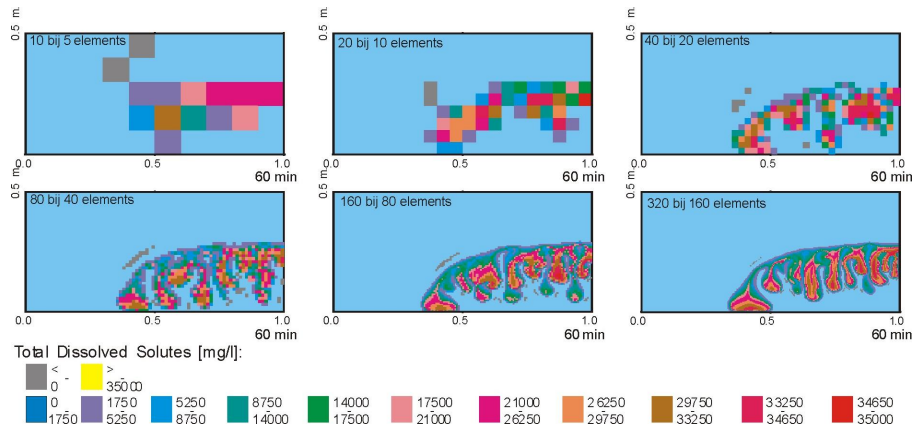

Size of cell has a large effect on modelling result!

Effect of size model cell on physical process

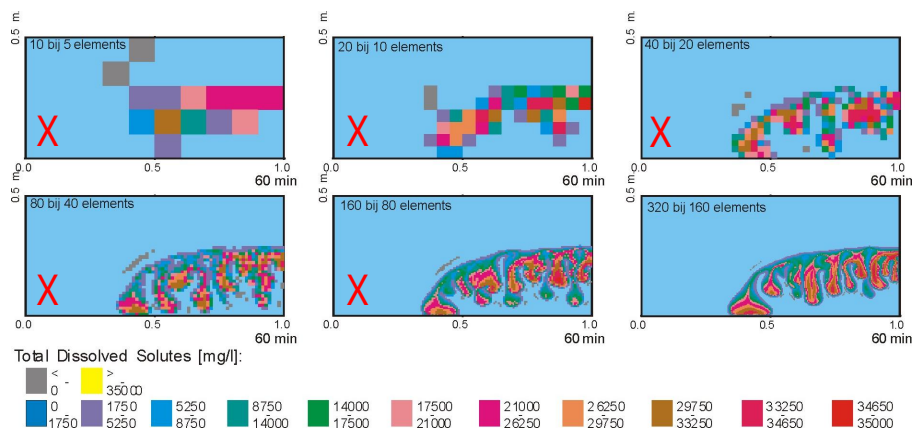

X= LOUSY models for predicting exact number of salt water fingers

Effect of size model cell on physical process

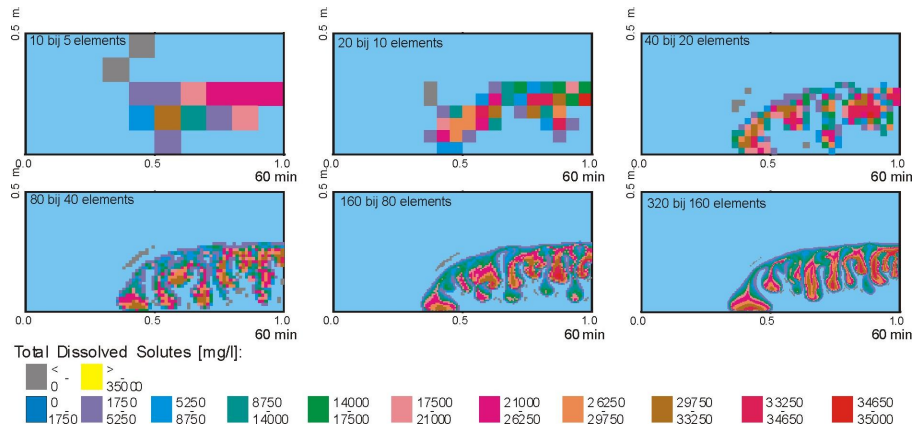

BUT: all models are GOOD for predicting the moment of touching the base!

cases

Salt water pocket in a fresh environment (VI)

Conclusion:

- For some physical processes, a large number of cells is necessary
- Check always grid convergence!

Different model scales: 5, 10, 25m2

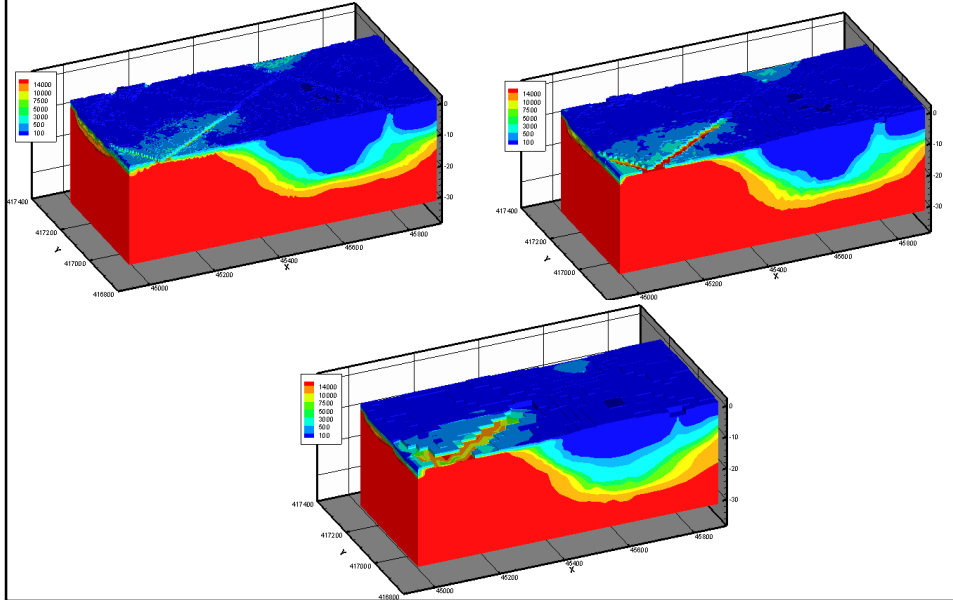

Different model scales

Which one is good enough?

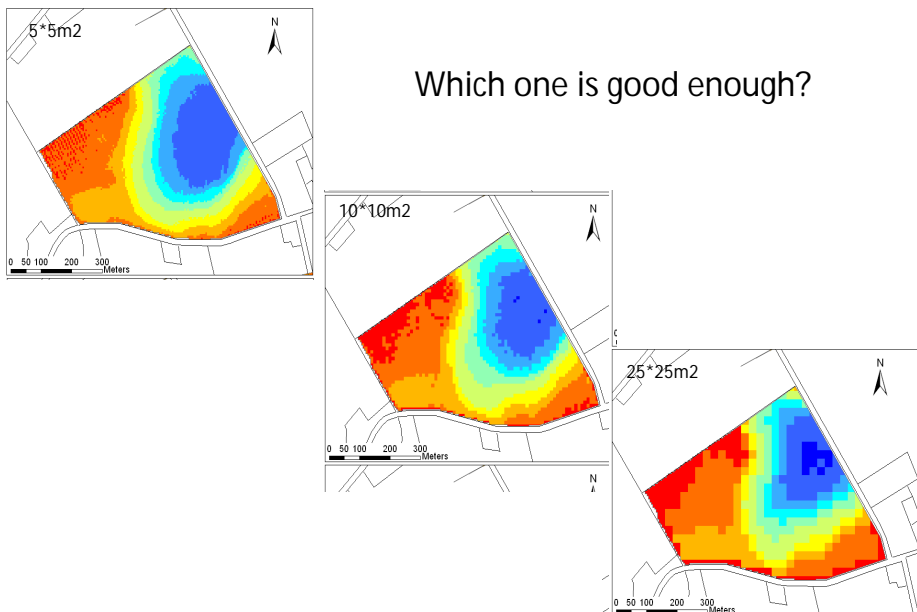

Upscaling issues: upconing under ditch

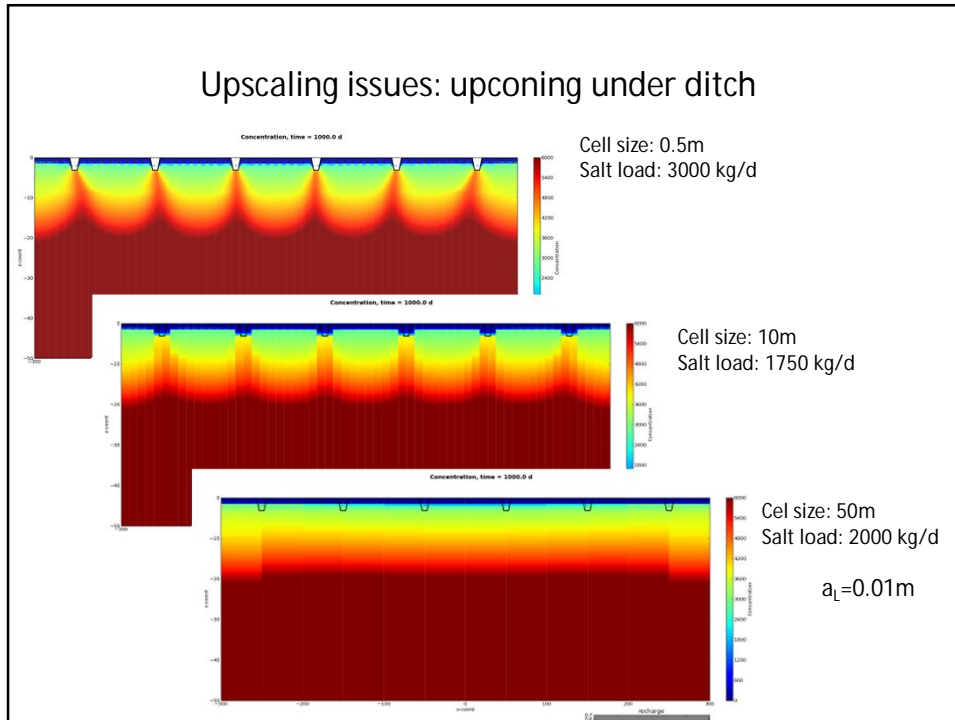

Henry's problem (1964)

cases

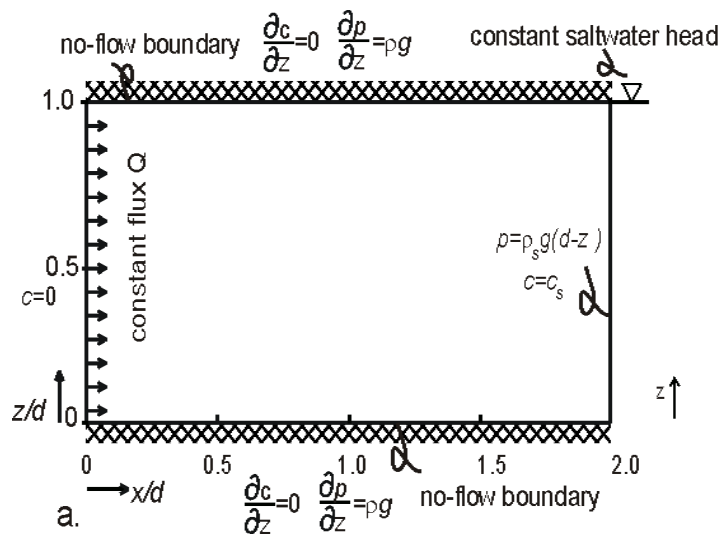

Henry's problem

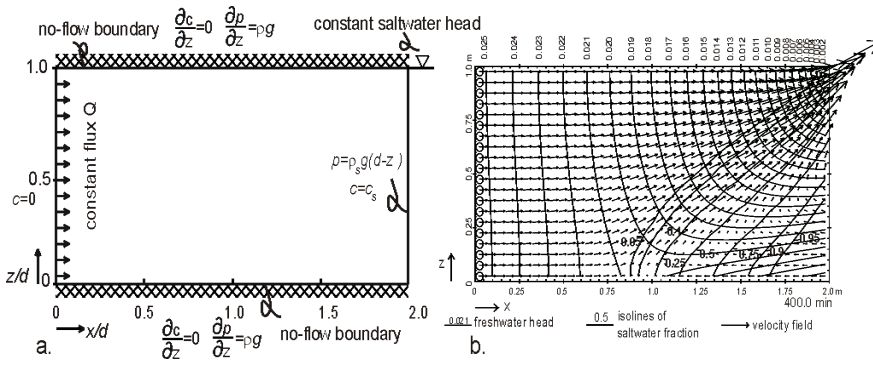

Henry's problem

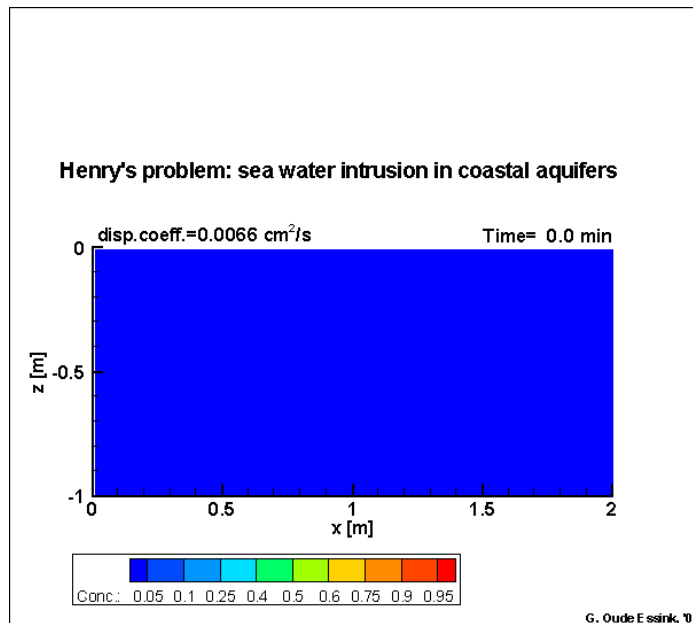

Henry's problem

Don't use the Henry problem as a variable-density benchmark, because even with a constant density model, the results are more or less the same!

Hydrocoin:

disposal of high-level nuclear waste
groundwater movement near salt domes
Gorleben salt dome, Germany

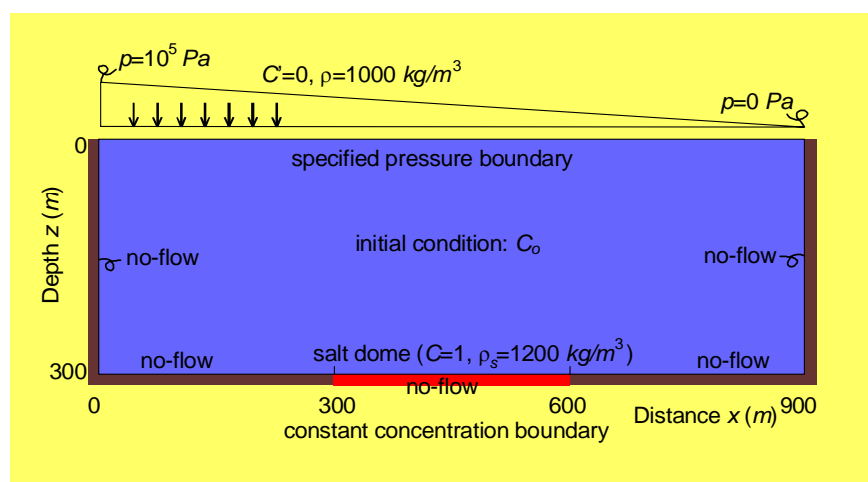

Hydrocoin: groundwater movement near salt domes

cases

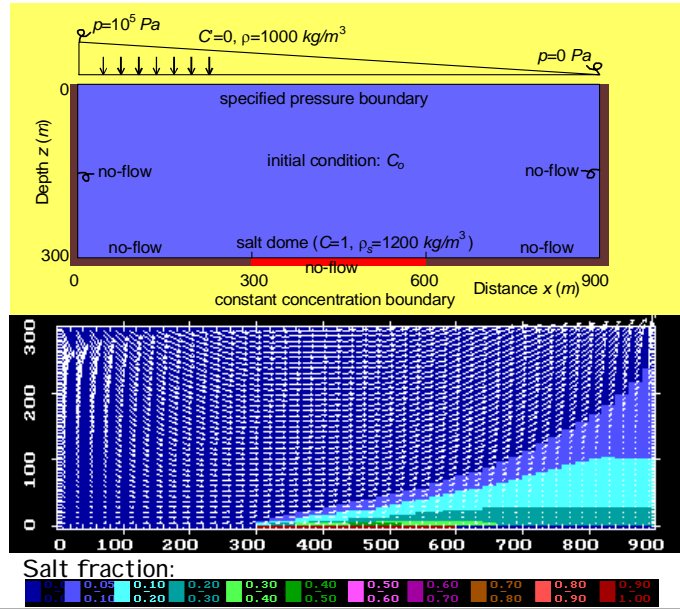

Broad 14 Basin, North Sea

Geofluids'03, with L. Bouw

cases

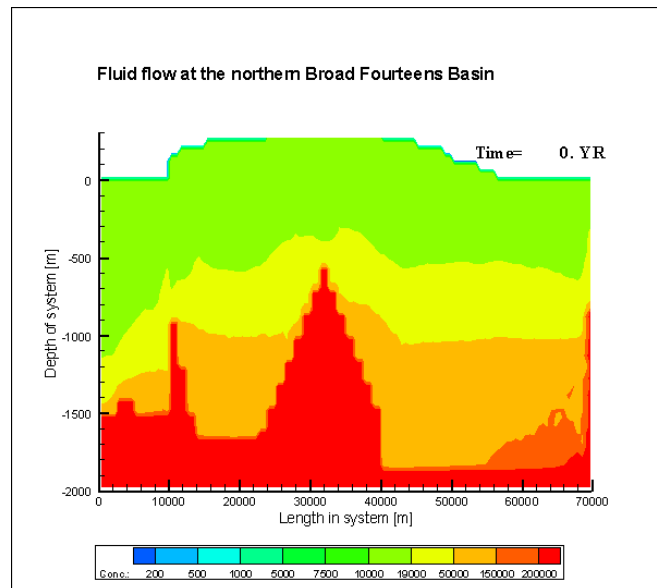

Bouw, L. & Oude Essink, G.H.P. 2003. Development of a freshwater lens in the inverted Broad Fourteens Basin, Netherlands offshore. *J. of Geochemical Exploration* (78-79), 321-325.

Hydrocoin: effect of boundary condition (I) cases
supply of brine through advection and hydrodynamic dispersion

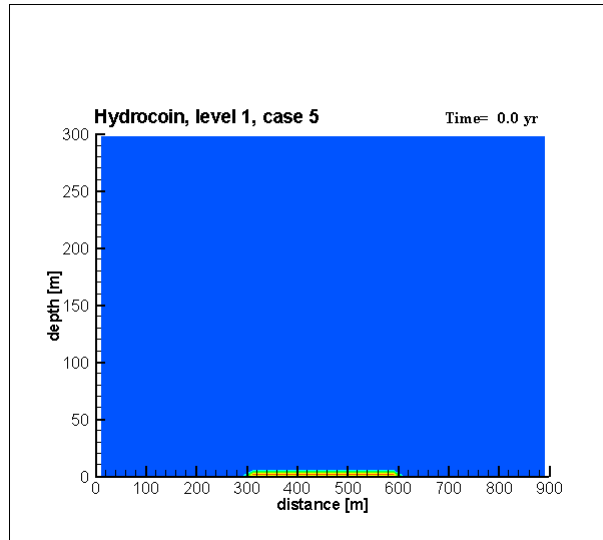

recirculation type

Hydrocoin: effect of boundary condition (I) cases
supply of brine through advection and hydrodynamic dispersion

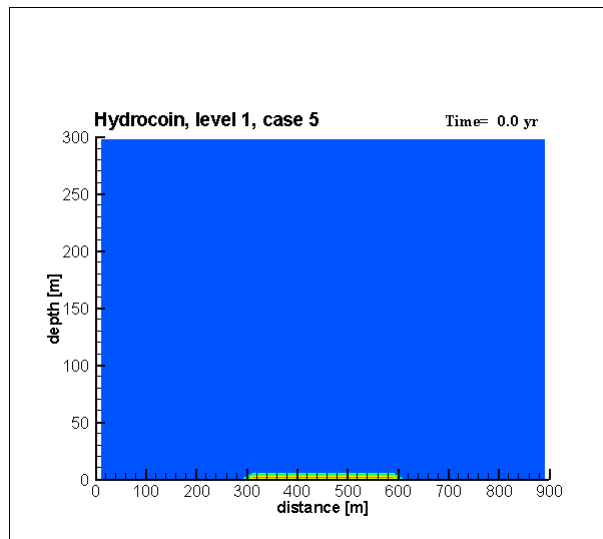

recirculation type

Hydrocoin: effect of boundary condition (II)
supply of brine through only hydrodynamic dispersion

cases

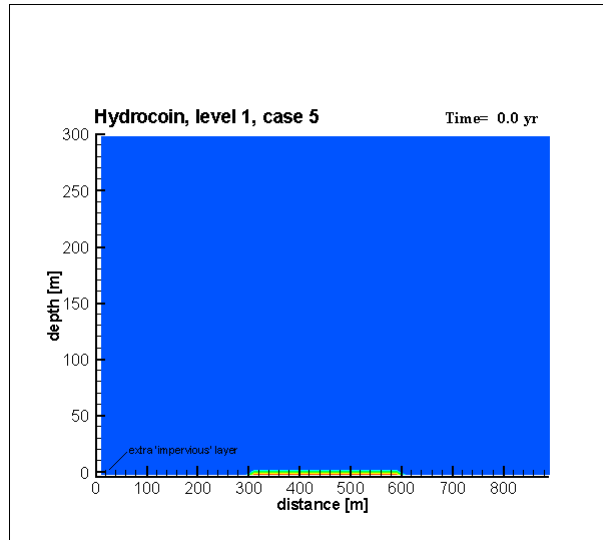

swept-forward type

Hydrocoin: effect of boundary condition (II)
supply of brine through only hydrodynamic dispersion

cases

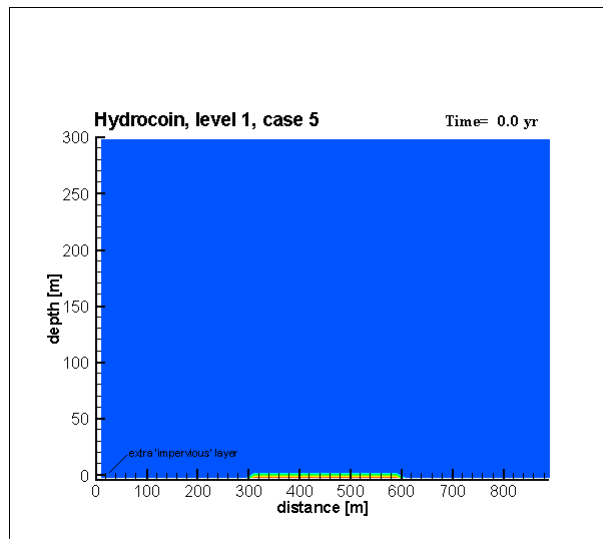

swept-forward type

Hydrocoin: difference recirculation vs swept forward

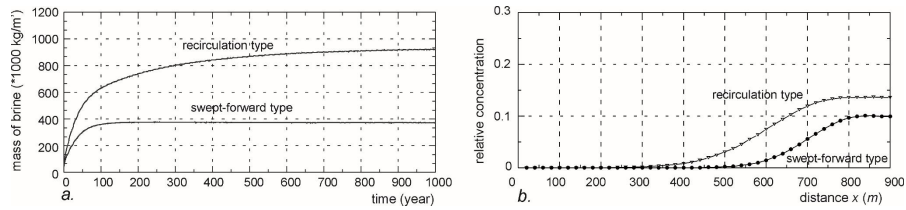

total mass of brine

brine conc at depth=200m

Lecture notes, p. 86-91

Hydrocoin: effect of vertical grid size

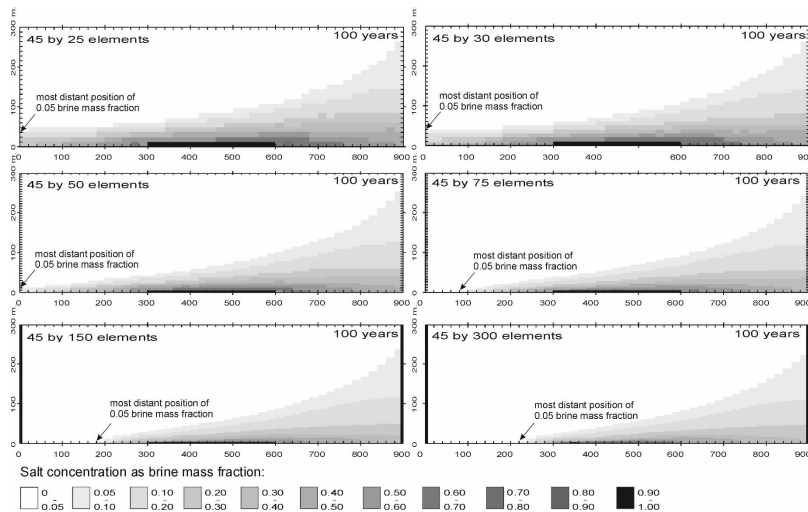

Recirculation type

Hydrocoin: effect of vertical discretization (III)

more vertical cells give better solution

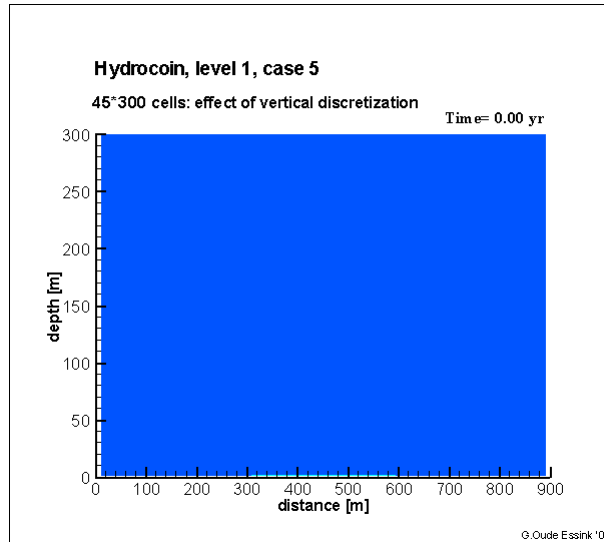

like the swept-forward type

Hydrocoin: effect of vertical discretization (III)

more vertical cells give better solution

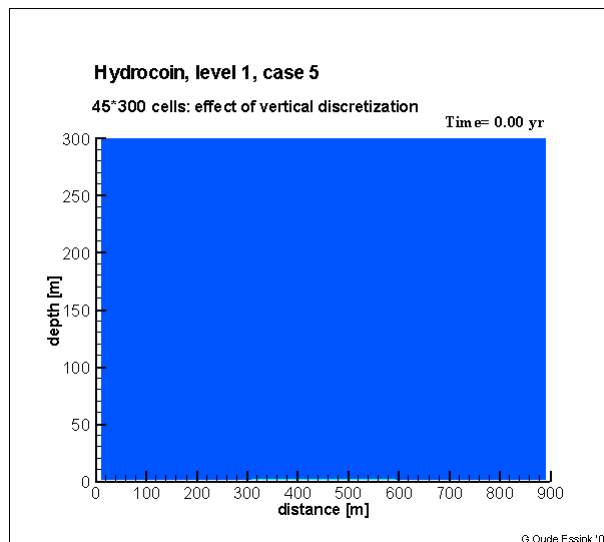

like the swept-forward type

Analogy physical processes

Heat transport (analogy with solute transport)

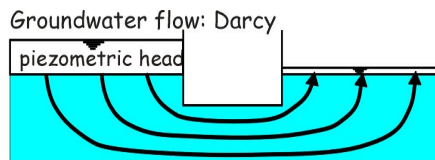

$$q = -k \frac{\partial \phi}{\partial x}$$

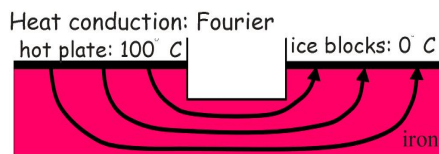

$$h = -\lambda \frac{\partial T}{\partial x}$$

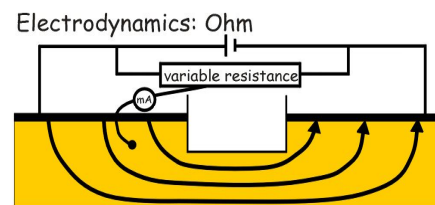

$$i = -\sigma \frac{\partial V}{\partial x}$$

Conduction and convection of heat

$$h = -\lambda_e \frac{\partial T}{\partial x} + n_e \rho c_f VT$$

thermal conductivity [Joule/(ms °C)]

$$\lambda_e = n_e \lambda_{fluid} + (1 - n_e) \lambda_{solid}$$

heat flux (Fourier) convection (fluid flow)

continuity equation

$$-\frac{\partial h}{\partial x} = \rho' c' \frac{\partial T}{\partial t}$$

specific heat capacity [Joule/(kg °C)]

$$\rho' c' = n_e \rho c_{fluid} + (1 - n_e) \rho_{solid} c_{solid}$$

Analogy solute and heat transport

Solute: advection-dispersion equation

$$\frac{\partial C}{\partial t} = \frac{\partial}{\partial x_i} \left(D_{ij} \frac{\partial C}{\partial x_j} \right) - \frac{\partial}{\partial x_i} (C V_i) + \frac{(C - C')W}{n_e}$$

Heat: convection-conduction equation

$$\rho' c' \frac{\partial T}{\partial t} = \frac{\partial}{\partial x_i} \left(\Lambda_{ij} \frac{\partial T}{\partial x_j} \right) - \rho c_f \frac{\partial T q_i}{\partial x_i} + \Gamma$$

Analogy heat and solute transport

Heat transport

Convection-conduction equation

$$\rho' c' \frac{\partial T}{\partial t} = \frac{\partial}{\partial x_i} \left(\Lambda_{ij} \frac{\partial T}{\partial x_j} \right) - \rho c_f \frac{\partial T q_i}{\partial x_i} + \Gamma$$

Equation of state: relation density & temperature

$$\rho_{i,j,k} = \rho_f (1 - \alpha_f T_{i,j,k})$$

Analogy between solute and heat transport

Solute	Heat
C	T
R_d	$1 + \frac{(1-n_e)\rho_s c_s}{n_e \rho c_f}$
D_m	$\frac{n_e \lambda_e + (1-n_e)\lambda_s}{n_e \rho c_f}$
λ	0

Energy storage in geothermal reservoirs

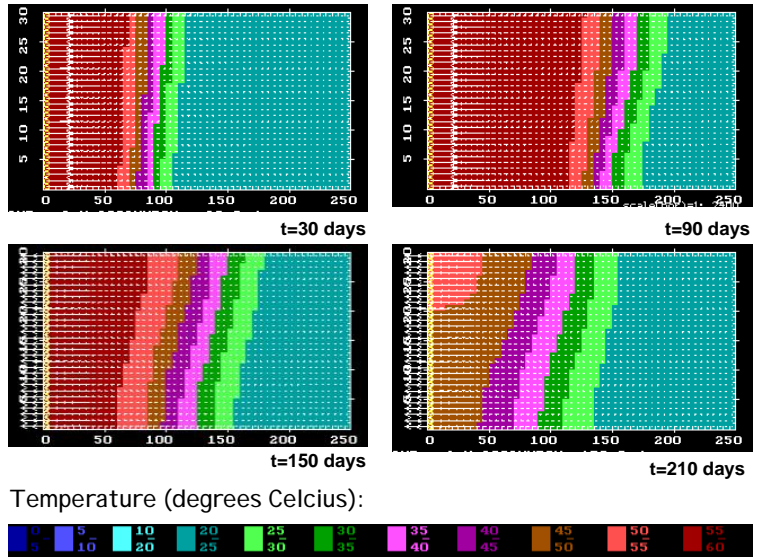

Elder problem (I)

It is originally a heat transport problem

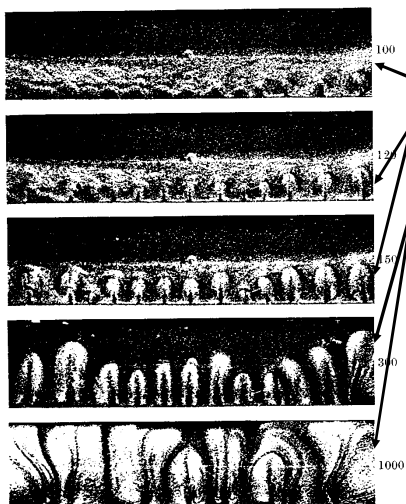

Phases:

1. Stable growth diffusive boundary layer
2. Development flow cells embedded in boundary layer
3. Emergence of disturbances that grow into fingers

Convection of heat occurs when:

$$\text{Rayleigh number} > 4\pi^2$$

Elder, J. Fluid Mech. 32, 69-96, 1968

Elder problem (II)

Analogy composition and heat

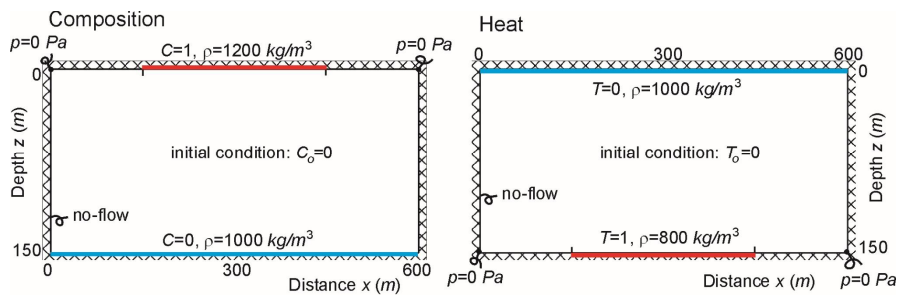

Lecture notes, p. 91-96

Case Elder, salt-fresh

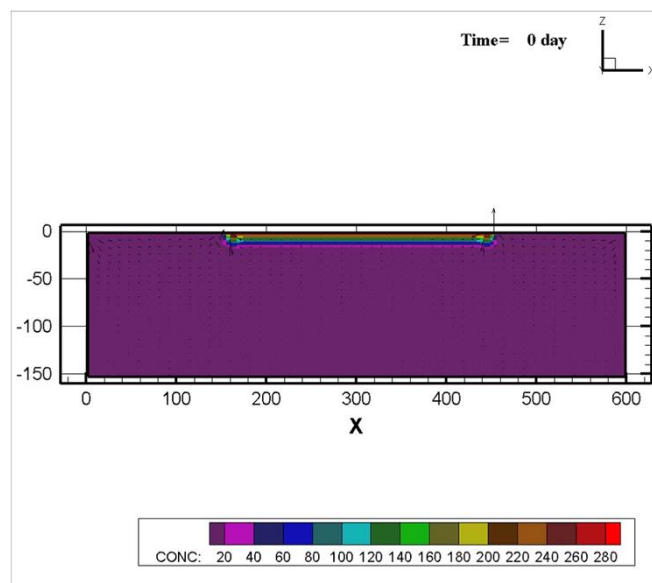

Elder problem (III)

Development of convection cells (Rayleigh number=400)

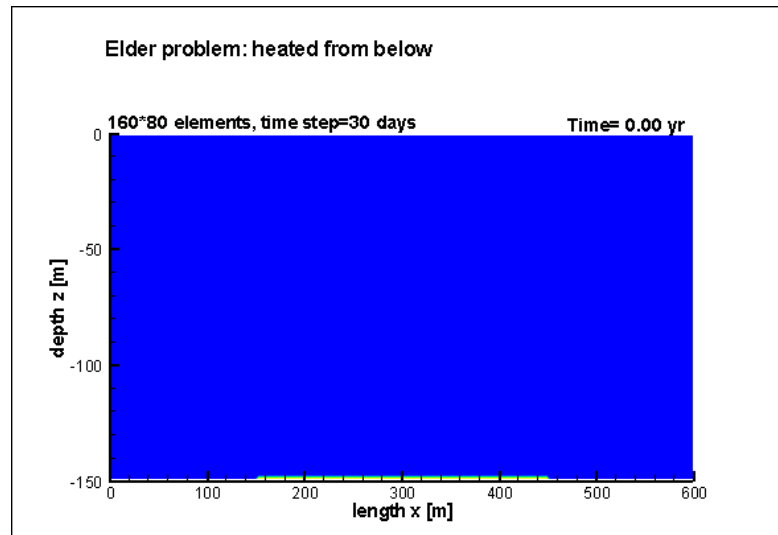

Elder problem (III)

Development of convection cells (Rayleigh number=400)

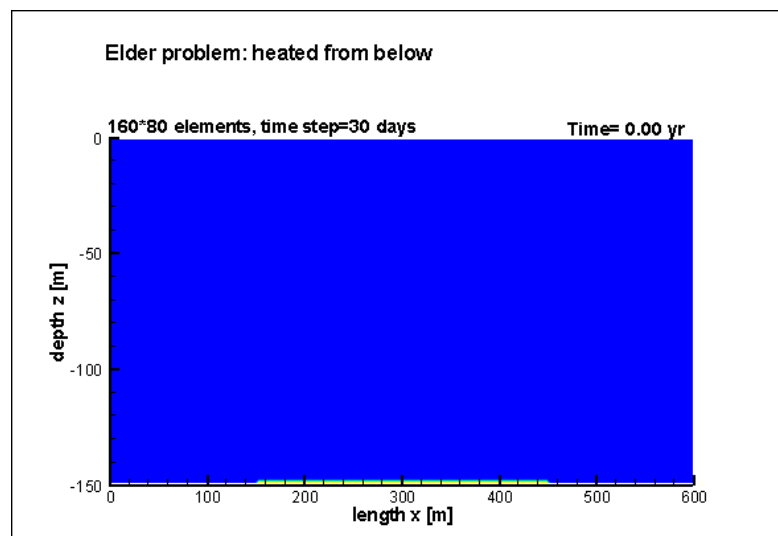

Heat transport (Rayleigh number=4000)

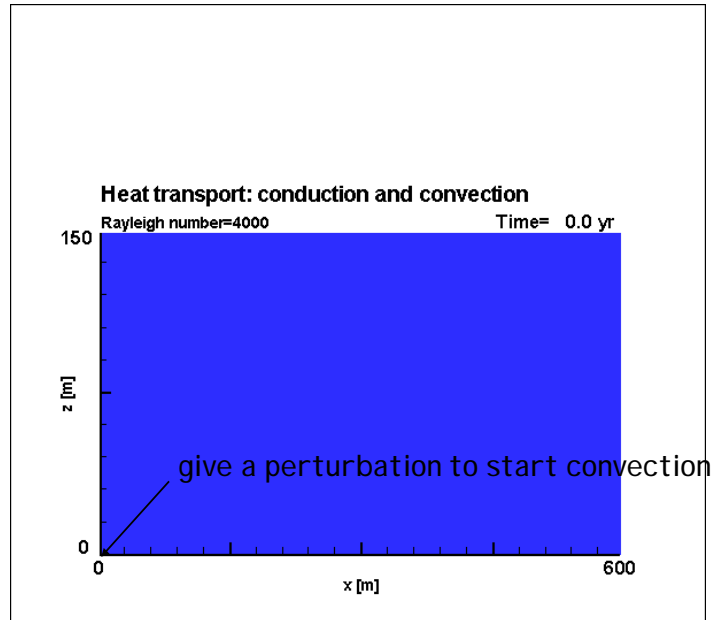

Impact of the 26-12-04 Tsunami on groundwater systems



Sri Lanka
Some days after December 26th, 2004

Impact of the 26-12-04 Tsunami on groundwater systems

Impression of relevant salinisation processes by conceptual models of salt water intrusion in coastal aquifers:

1. Fingering processes in the subsoil
2. Evolution of a freshwater lens after flooding by sea water
3. Freshwater lens in a coastal aquifer with a brackish lagoon

Next step:
quantifying processes in real situations, using topographic and hydrogeological data, and ending up with vulnerability maps

Concept 1: Fingering processes in the subsoil

Case Sri Lanka: lagoon setting

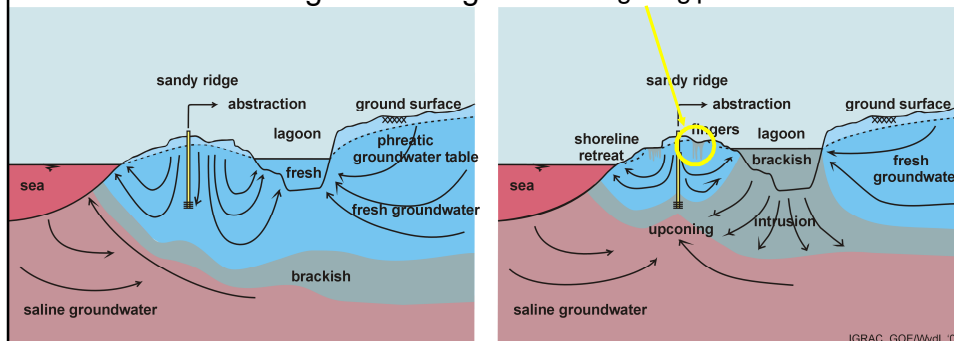

Before the Tsunami

After the Tsunami

Concept 1: Fingering processes in the subsoil

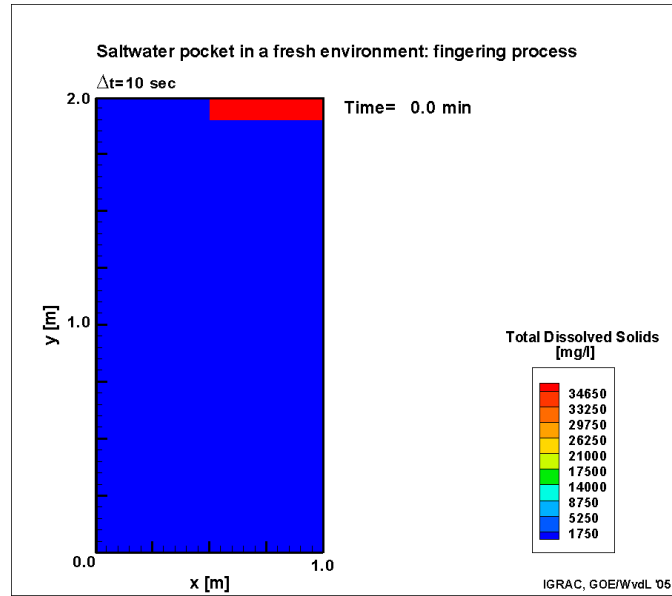

Concept 1: Fingering processes in the subsoil

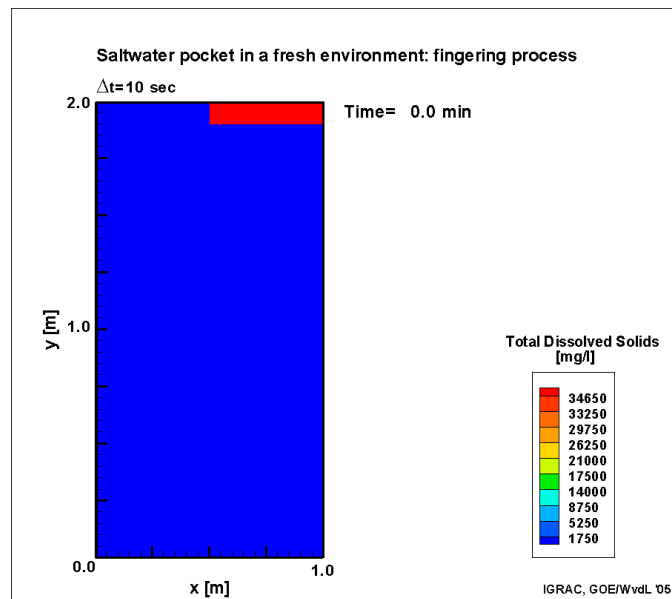

Concept 1: Fingering processes in the subsoil

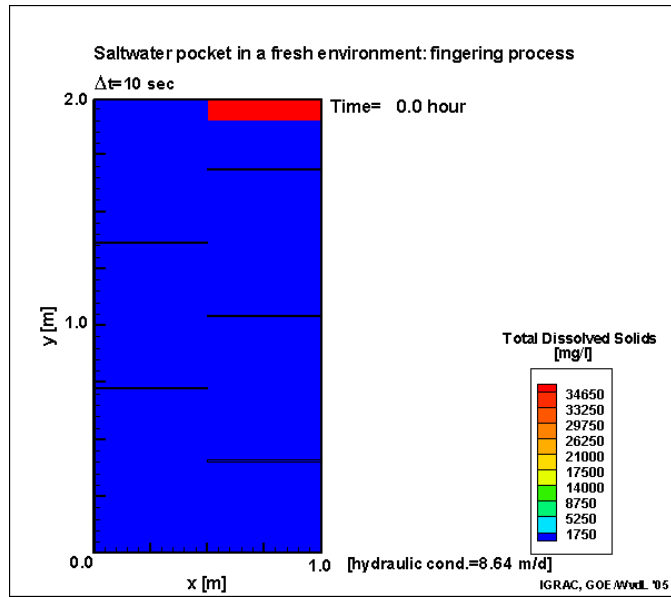

Concept 1: Fingering processes in the subsoil

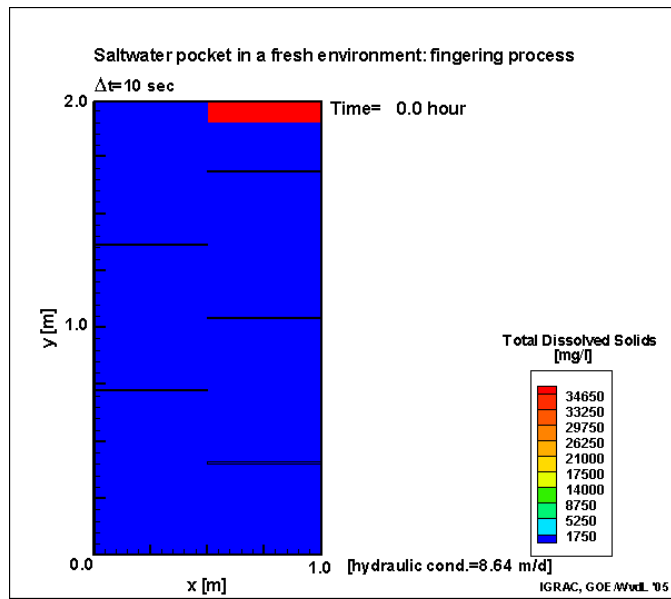

Concept 1: Fingering processes in the subsoil

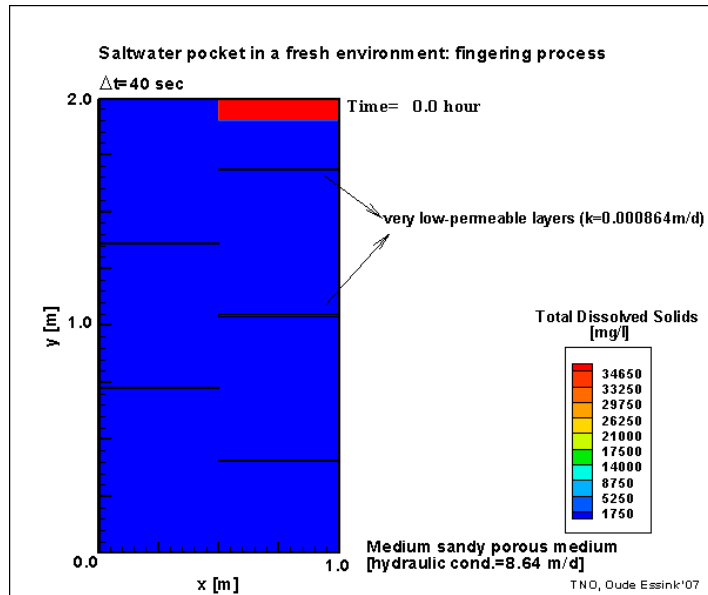

Concept 1: Fingering processes in the subsoil

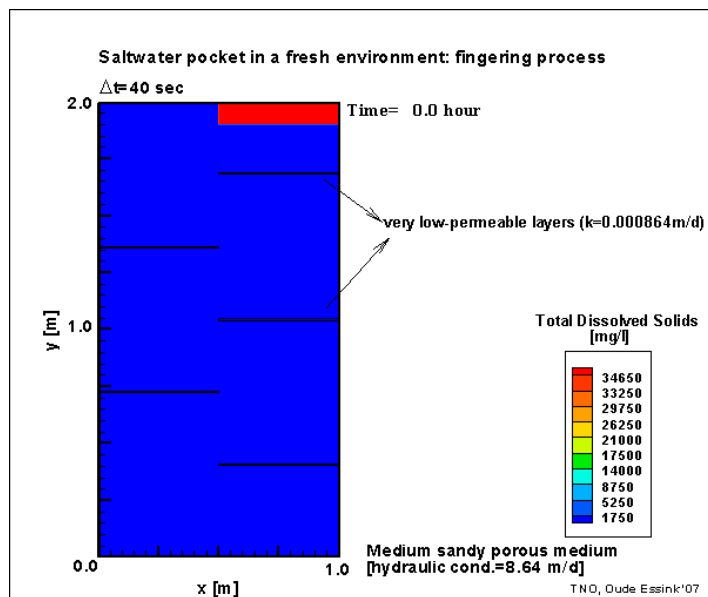

Concept 1: Fingering processes in the subsoil

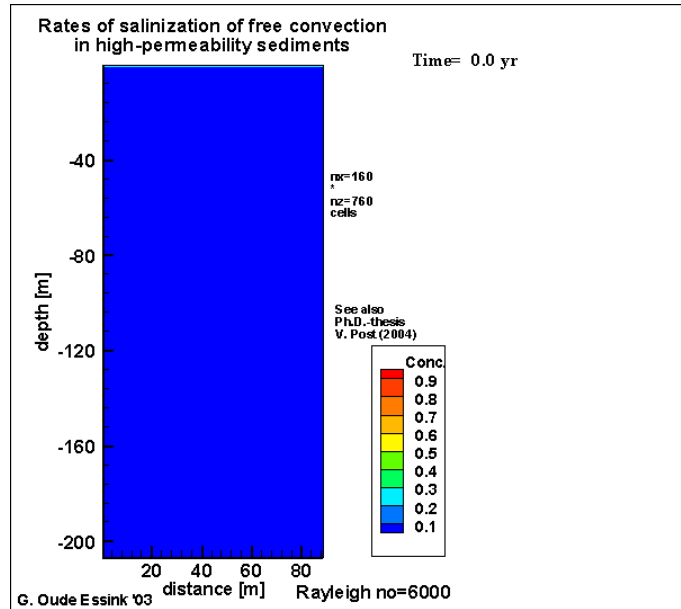

Concept 1: Fingering processes in the subsoil

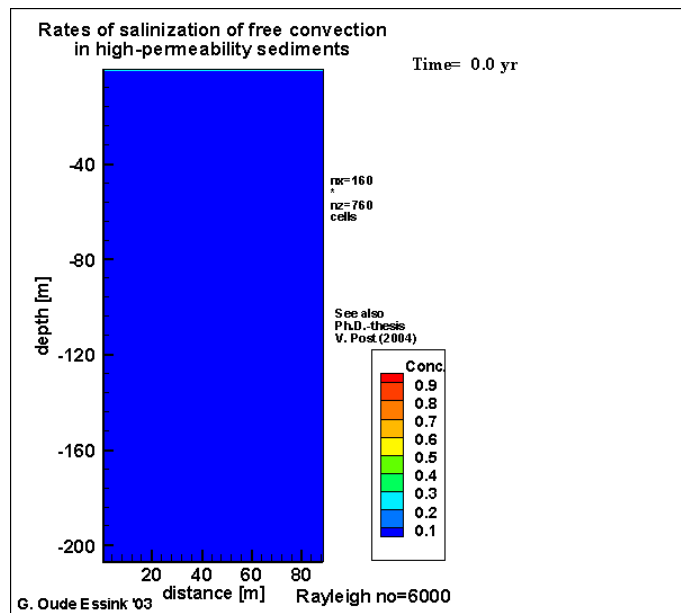

Fingering processes in the subsol

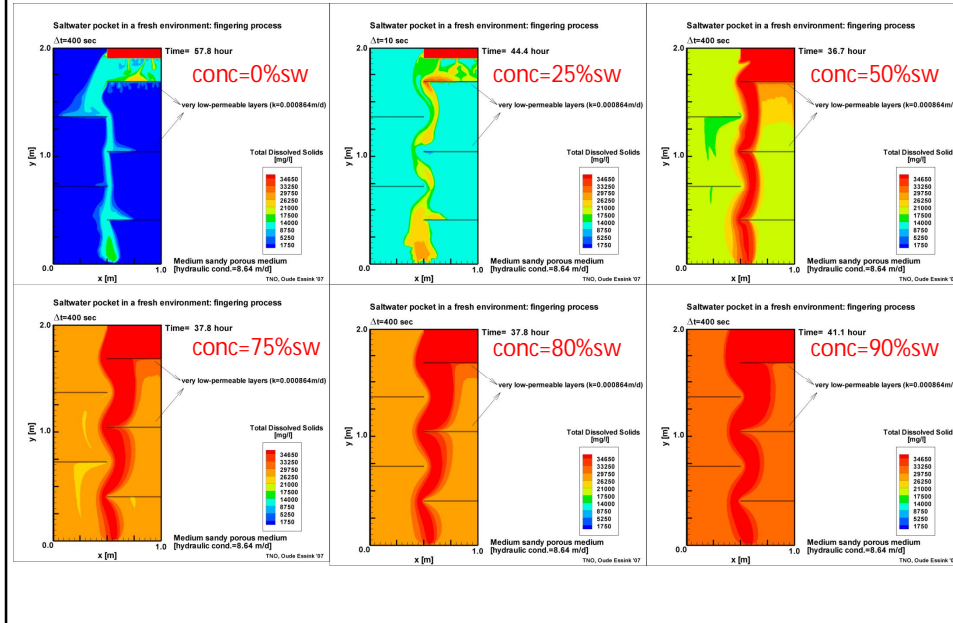

Concept 2: Evolution of a freshwater lens after flooding

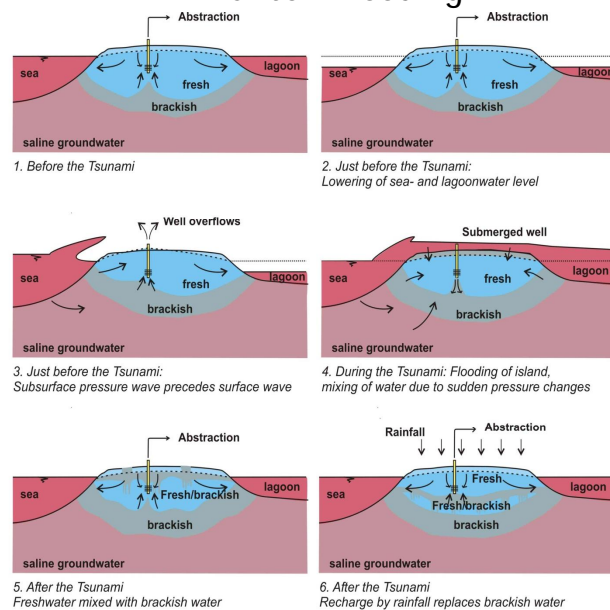

Concept 2: Evolution of a freshwater lens after flooding

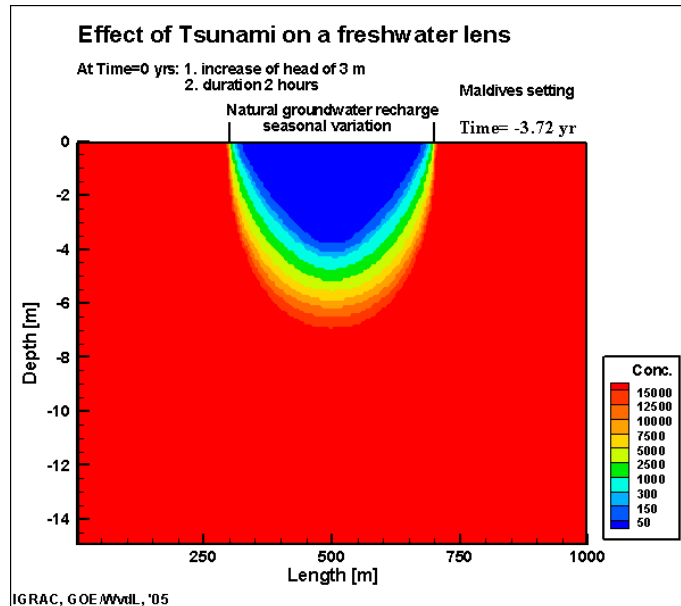

Concept 2: Evolution of a freshwater lens after flooding

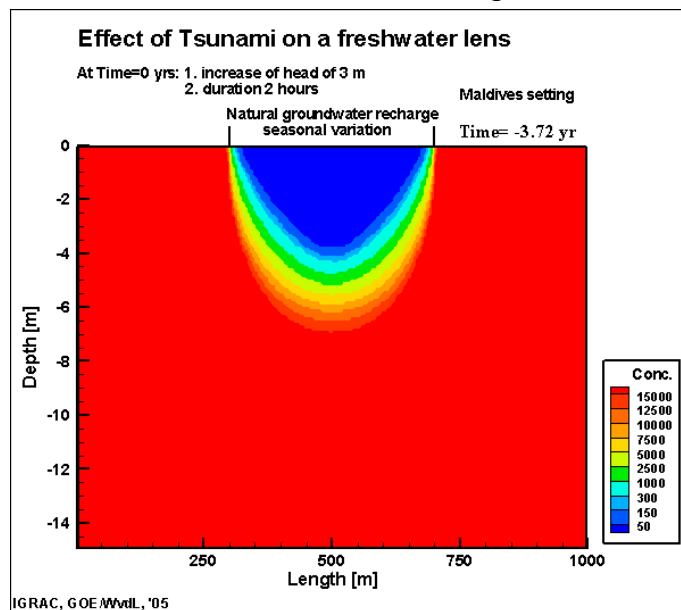

Concept 2: Evolution of a freshwater lens after flooding

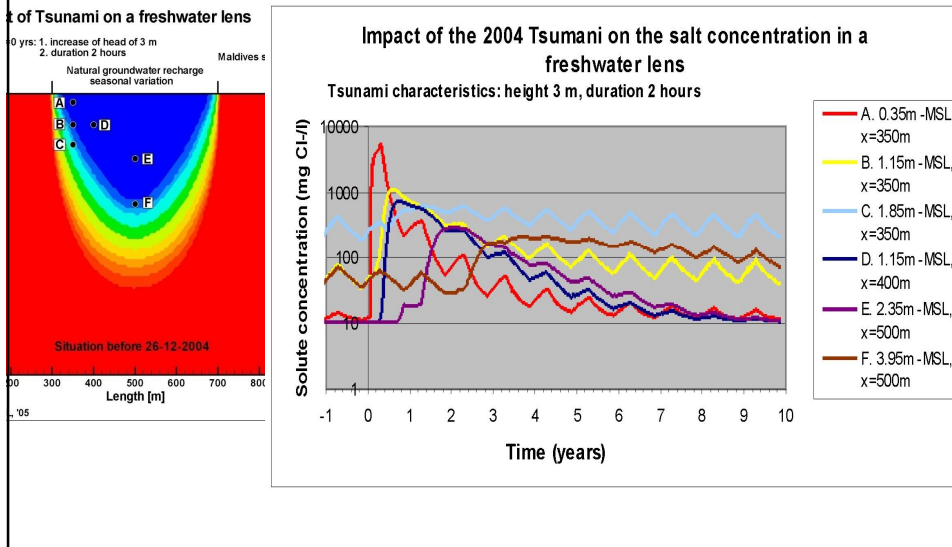

Concept 3: Freshwater lens in a coastal aquifer with a brackish lagoon

Case Sri Lanka: lagoon setting

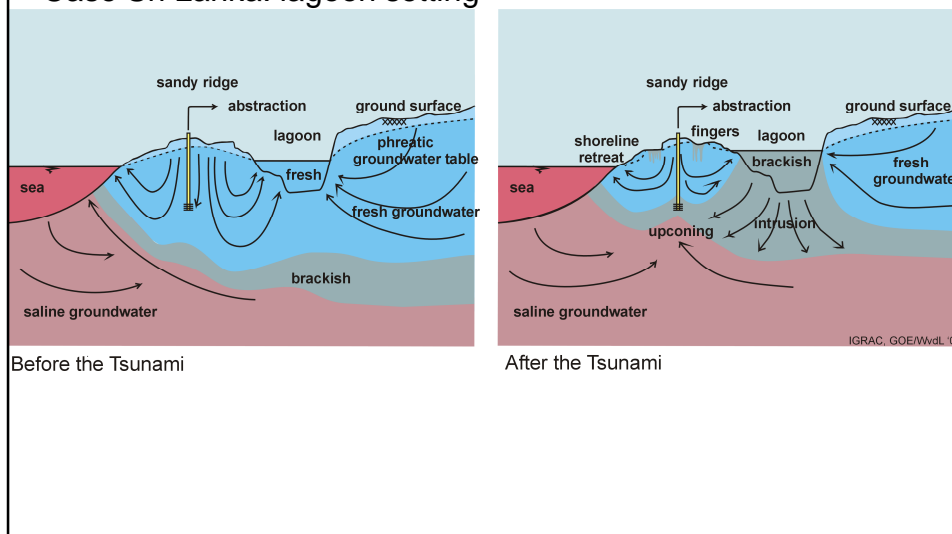

Concept 3: Freshwater lens in a coastal aquifer with a brackish lagoon

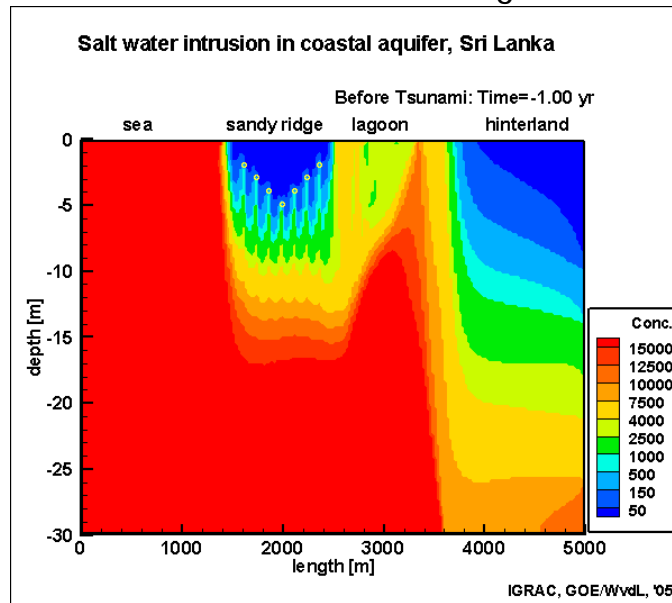

Concept 3: Freshwater lens in a coastal aquifer with a brackish lagoon

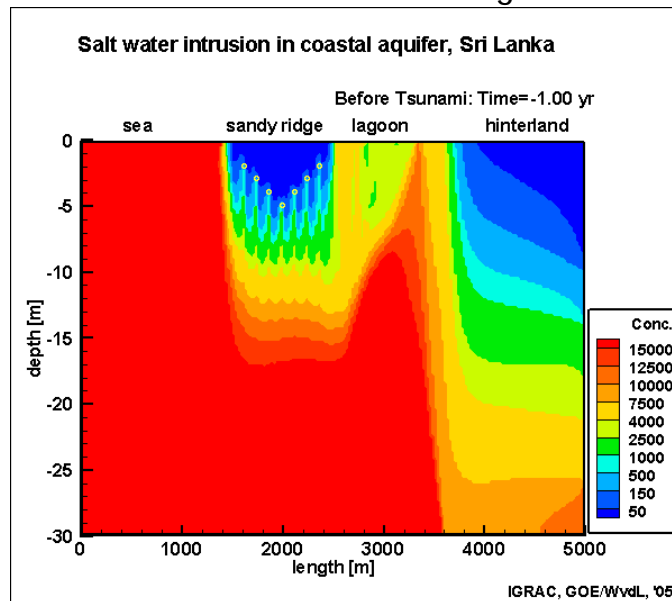

Concept 3: Freshwater lens in a coastal aquifer with a brackish lagoon

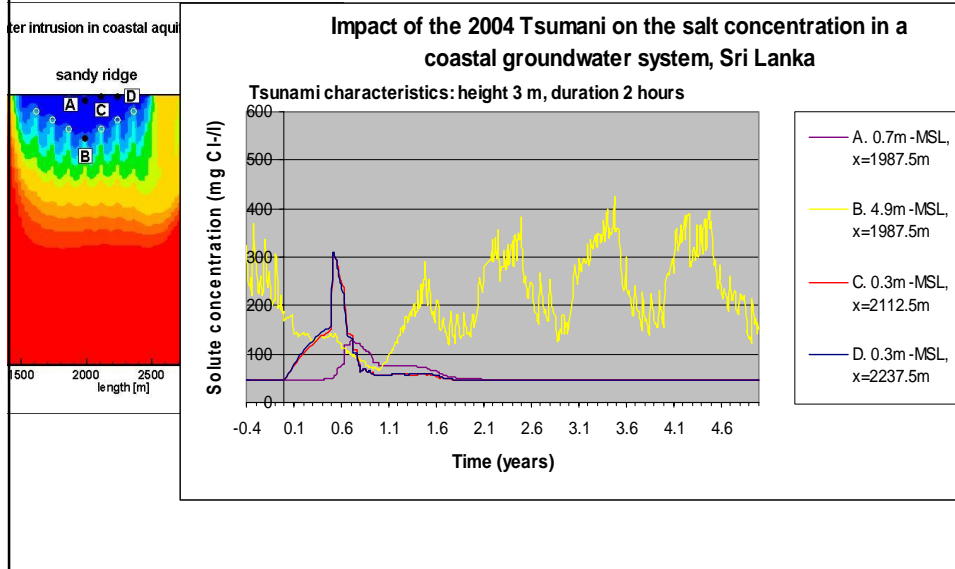

Effect sea level rise

Effects of sea level rise on groundwater resources in deltaic areas

1. Increase of salt water intrusion
2. Increase of upconing under groundwater extraction wells
3. Increase of piezometric head
4. Increase of seepage and salt load to the surface water system
5. Risk of instable Holocene aquitards
6. [Decrease of fresh groundwater reservoirs due to decrease in natural groundwater recharge]

Effects of sea level rise on groundwater resources in deltaic areas

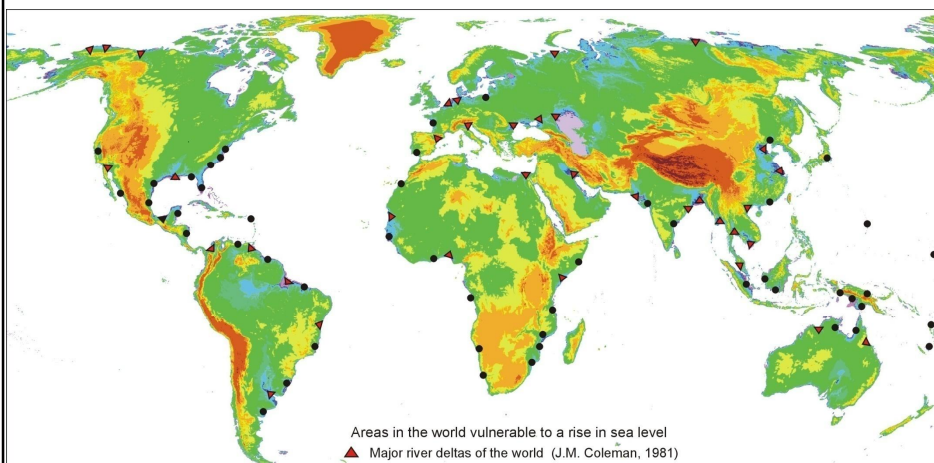

Digital Elevation Model (DEM)

Effect of sea level rise:
Analytical approach for zone of influence in deltaic areas

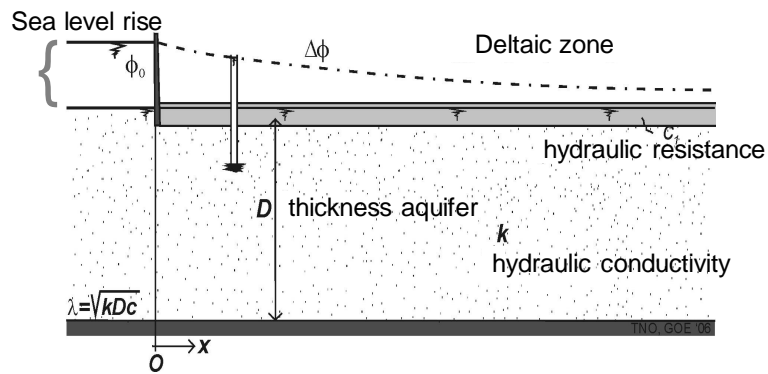

$$\Delta\phi(x) = \phi_0 e^{-x/\lambda}$$

$$\lambda = \sqrt{kDc}$$

- Zone of influence is equal to sqrt(kDc)
- At $x=3\lambda$, only 5% of sea level rise is detectable

Effect of sea level rise:
Case 1 with Dutch subsoil parameters

$kD = 1000 \text{ m}^2/\text{day}$
 $c = 1000 \text{ day}$
 $\lambda = 1000 \text{ m}$

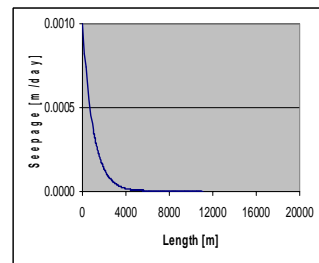
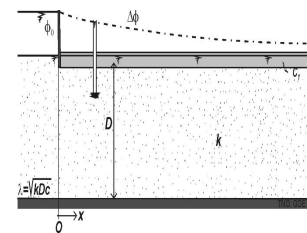
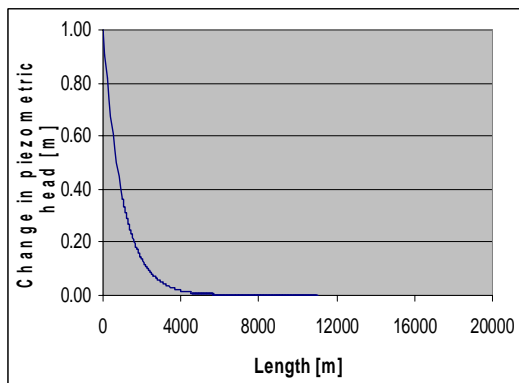

Effect of sea level rise:

Case 2 with Dutch subsoil parameters

kD = 5000 m²/day
c = 5000 day
λ = 5000 m

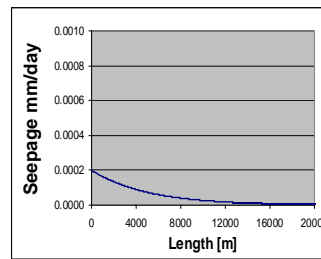
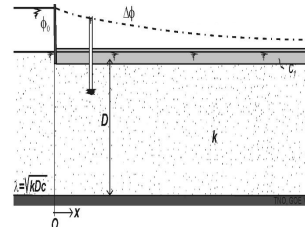
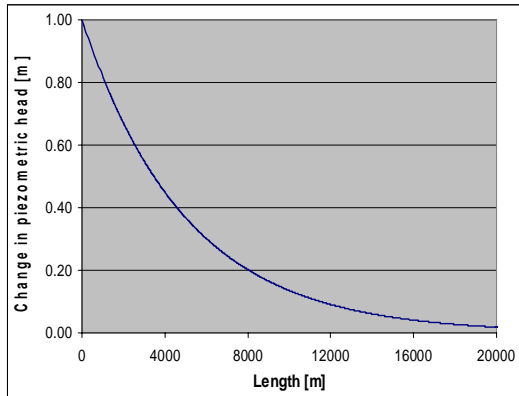

Case 3 with Dutch subsoil parameters

kD = 5000 m²/dag
c1 = 5000 dag, c2 = 50 dag

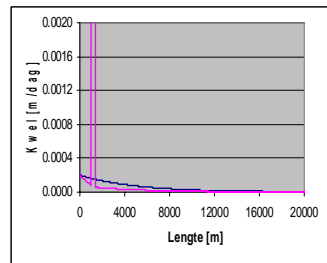
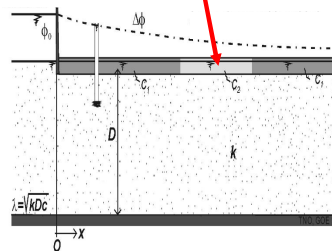
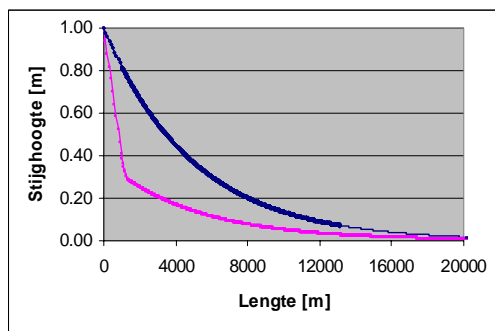

Climate change is HOT!



Past and future sea level rise in the Netherlands

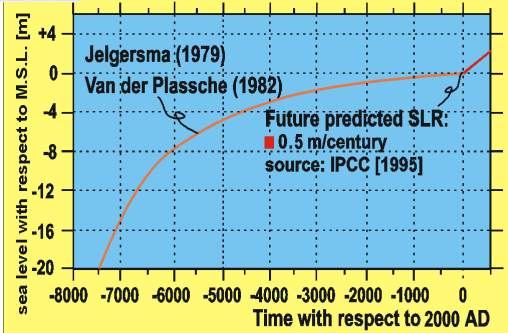
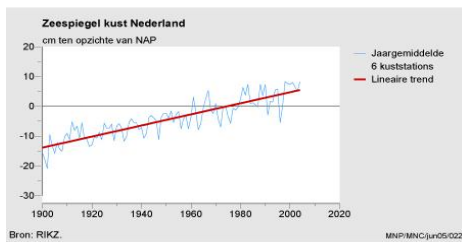

Implementing new KNMI 06 climate scenarios

2100		G	G+	W	W+	C	C+
	Worldwide temperature rise in 2050	+1°C	+1°C	+2°C	+2°C	+3°C	+3°C
	Worldwide temperature rise in 2100	+2°C	+2°C	+4°C	+4°C	+6°C	+6°C
	Change in airstream pattern Western Europa	no	yes	no	yes	no	yes
Winter	Average temperature	+1,8°C	+2,3°C	+3,6°C	+4,6°C	+5,4°C	+6,9°C
	Coldest winter day each year	+2,1°C	+2,9°C	+4,2°C	+5,8°C	+6,3°C	+7,8°C
	Average precipitation	7%	14%	14%	28%	21%	42%
Summer	Average temperature	+1,7°C	+2,8°C	+3,4°C	+5,6°C	+5,1°C	+8,4°C
	Hottest summer day each year	+2,1°C	+3,8°C	+4,2°C	+7,6°C	+6,3°C	+11,4°C
	Average precipitation	6%	-19%	12%	-38%	18%	-57%
Sea level rise	Absolute rise (cm)	35-60	35-60	40-85	40-85	45-110	45-110

Introduction

Effect of a relative sea level rise (1):

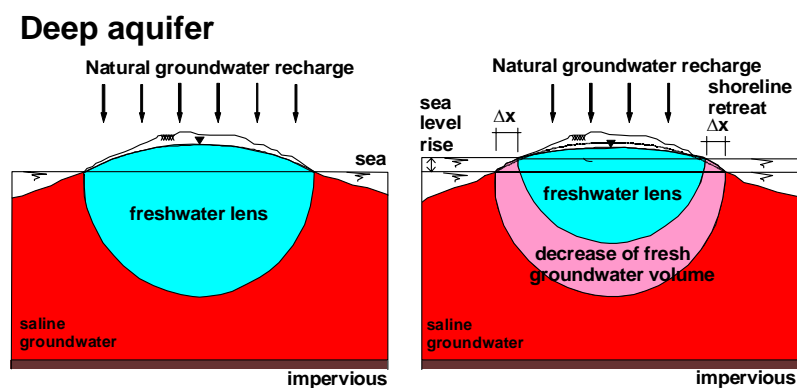

Effect of a relative sea level rise (2):

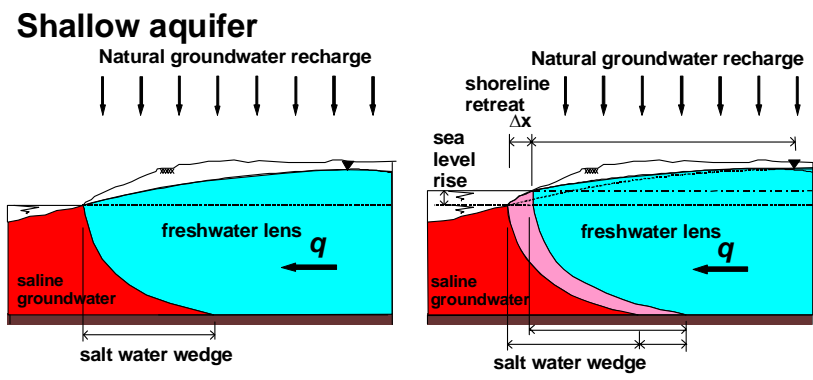

Effect of a relative sea level rise (3):

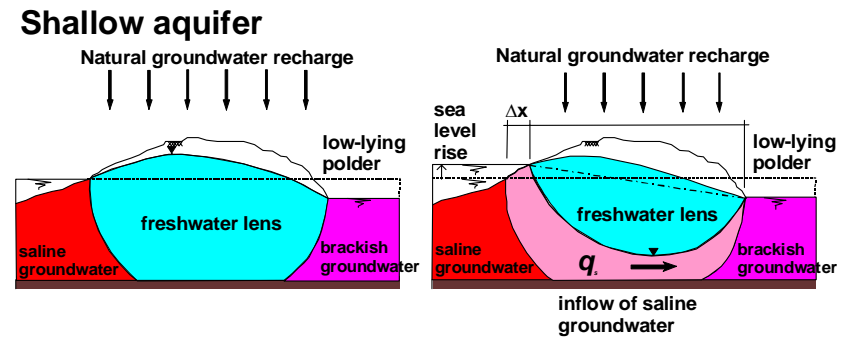

2D Profile and effect sea level rise

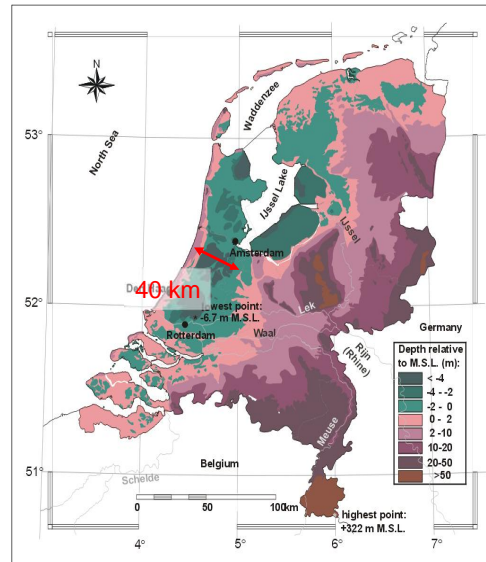

Verzilting van het regionale grondwater systeem door autonome processen (geen zeespiegelstijging)

Tijd= 1990 AD

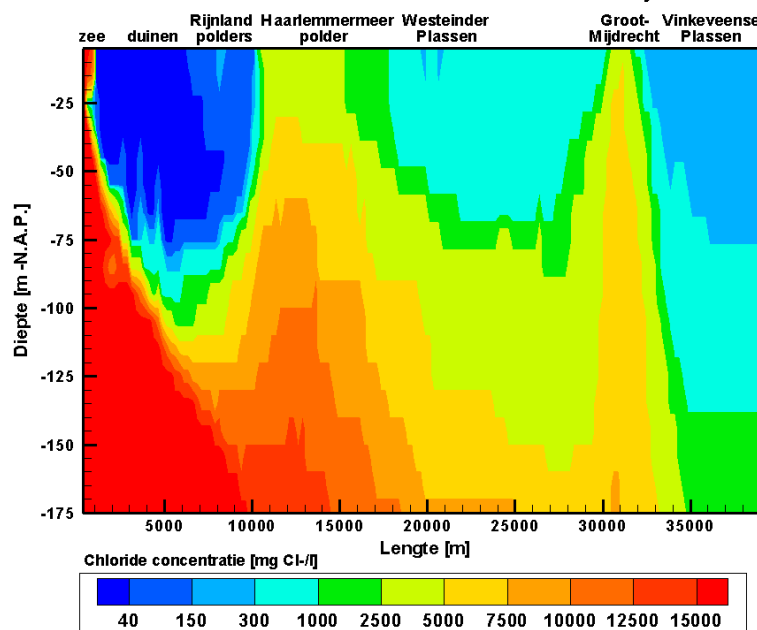

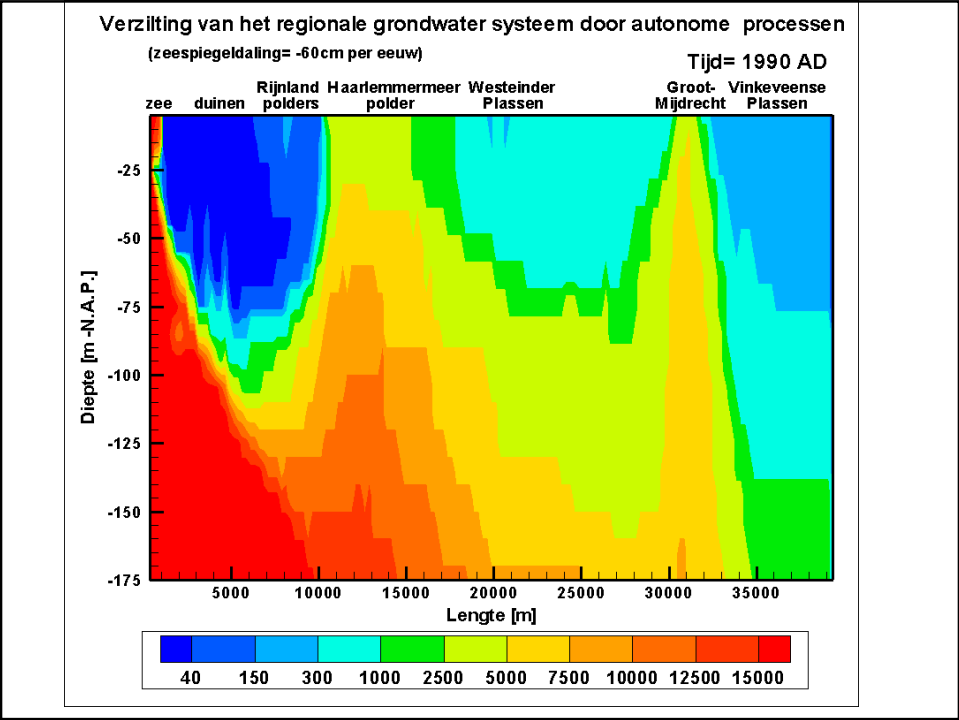
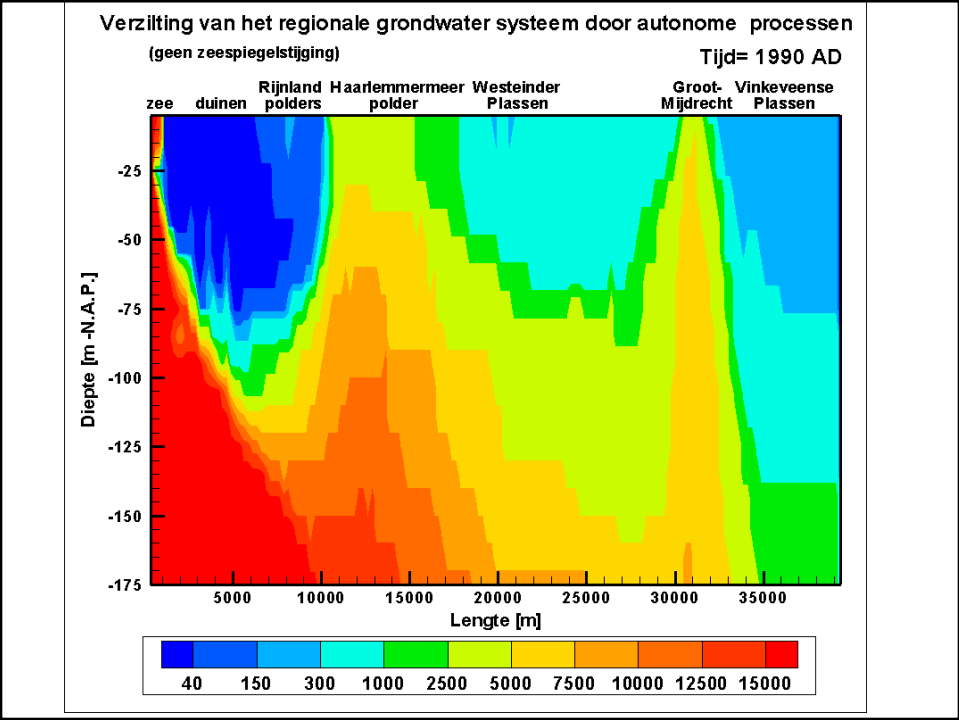

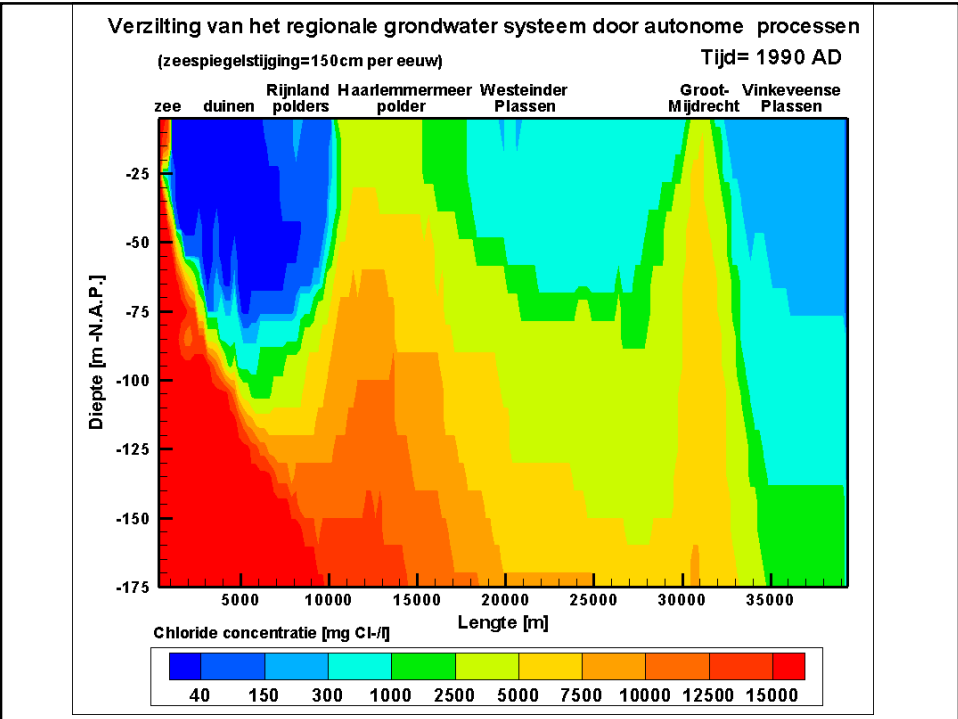
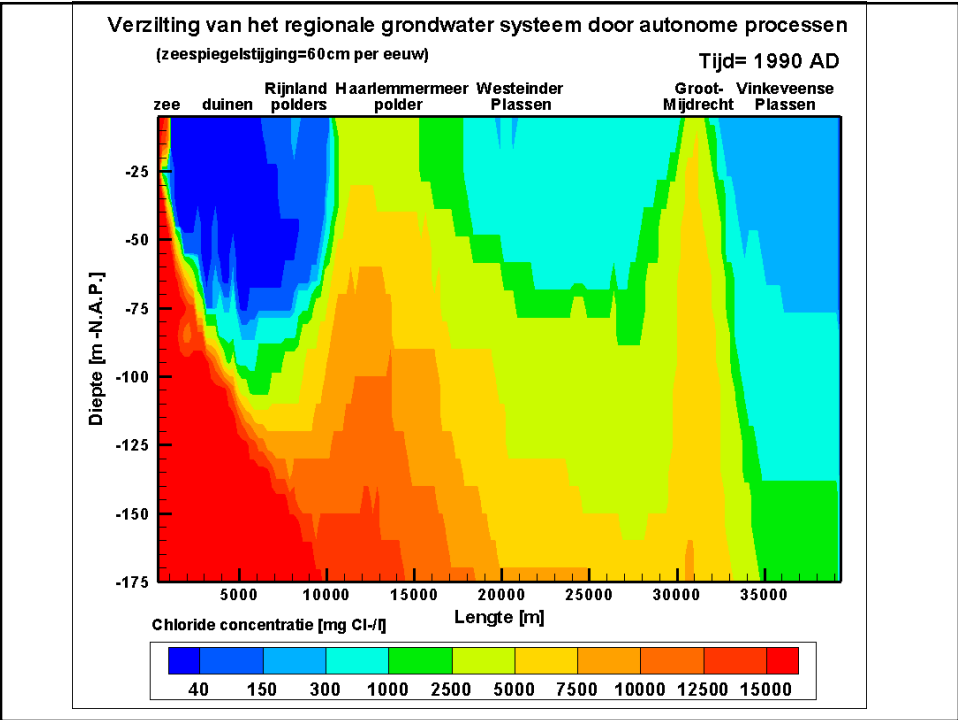

Point water head and Freshwater head ϕ_f

Piezometric head ϕ

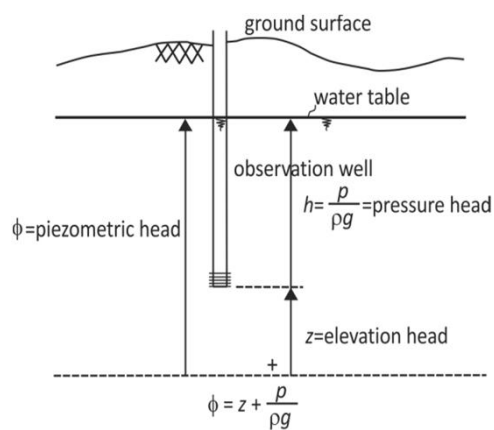

$$\phi = \frac{p}{\rho g} + z$$

$$p = \rho g (\phi - z)$$

Freshwater head ϕ_f

$$\phi_f = \frac{P}{\rho_f g} + z$$

1. Groundwater with different densities can be compared
2. Fictive parameter
3. Hydrologists like to use heads instead of pressures
4. Pressure sometimes better
5. Confusing (heads not perpendicular to streamlines)

Freshwater head ϕ_f

$$h_f = \frac{\rho}{\rho_f} h$$

$$\phi_f = h_f + z$$

$$\phi_f = \frac{\rho}{\rho_f} h + z$$

e.g.:
 $\rho_s = 1025 \text{ kg/m}^3$
 $h = 10 \text{ m}$
 $\phi_f = 10.25 \text{ m}$

Special case: hydrostatic pressure: $q_z=0$

$$q_z = -\frac{\kappa_z \rho_f g}{\mu} \left(\frac{\partial \phi_f}{\partial z} + \frac{\rho - \rho_f}{\rho_f} \right) \quad \text{no vertical flow}$$

$$0 = \left(\frac{\partial \phi_f}{\partial z} + \frac{\rho - \rho_f}{\rho_f} \right)$$

$$\partial \phi_f = -\frac{\rho - \rho_f}{\rho_f} \partial z$$

$$\phi_{f2} = \phi_{f1} - \frac{\rho - \rho_f}{\rho_f} (z2 - z1)$$

$$\downarrow + \quad \phi_{f2} = \phi_{f1} + \frac{\rho - \rho_f}{\rho_f} (\Delta z)$$

Hydrostatic boundary condition at the sea

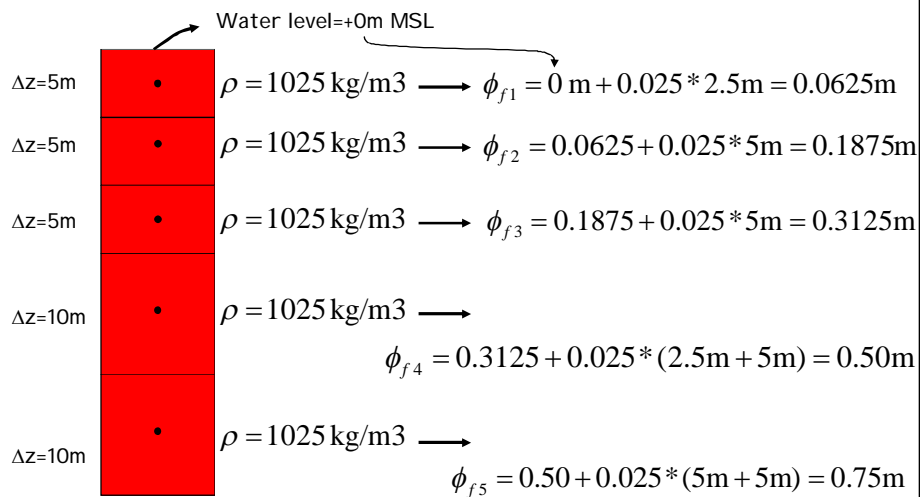

$$\phi_{f2} = \phi_{f1} + \frac{\rho - \rho_f}{\rho_f} (\Delta z)$$

Hydrostatic boundary condition at the sea

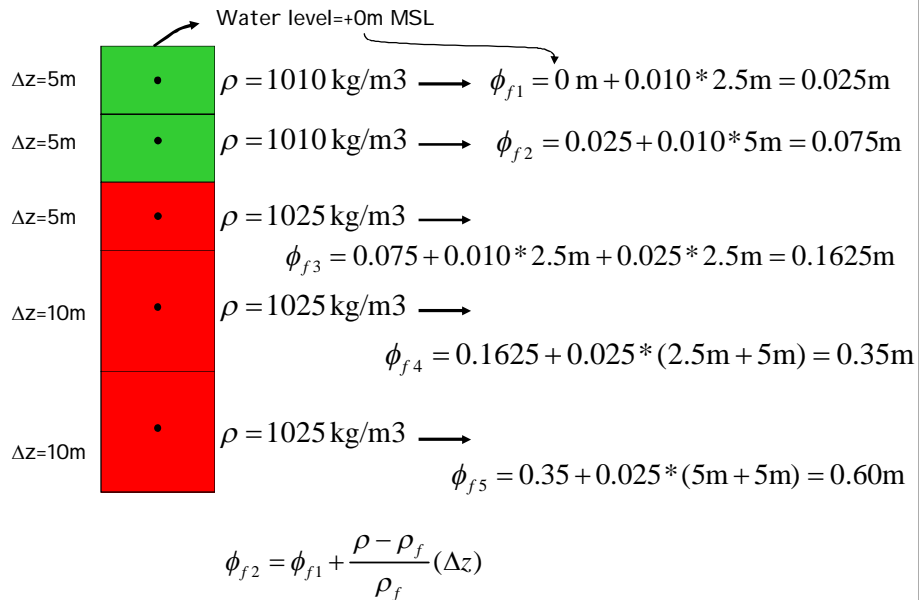

Example 2D profile NHI model freshwater head ϕ_f

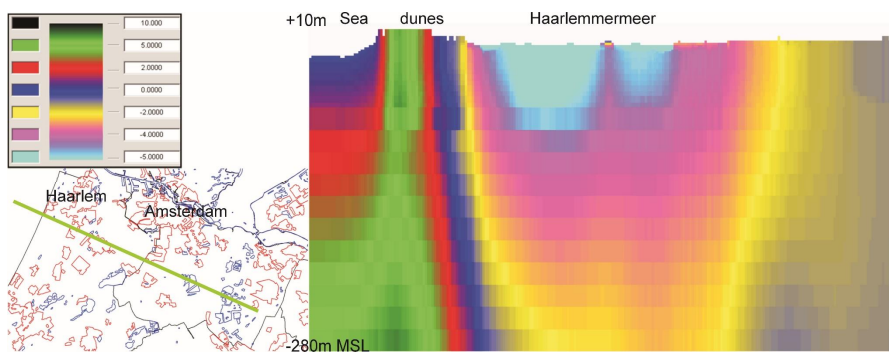

Which one is useful?

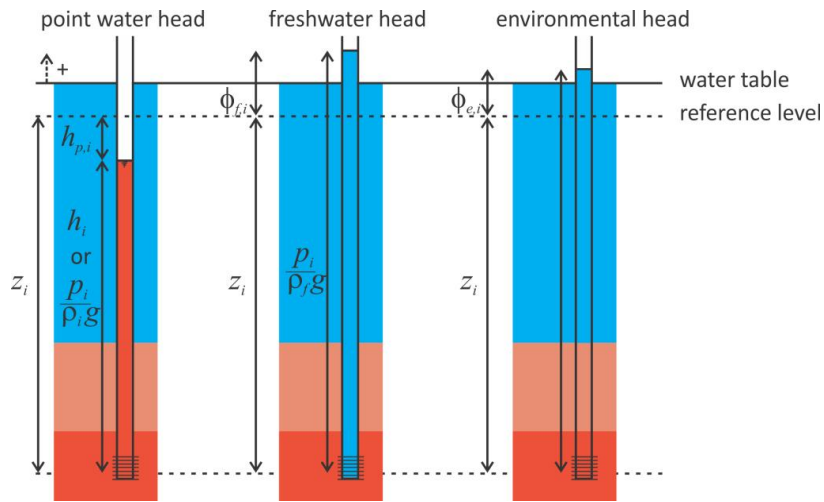

Post, Kooi and Simmons, 2007, Ground Water

Point water head

$$h_{p,i} = z_i + h_i \iff h_i = h_{p,i} - z_i$$

$$h_i = \frac{p_i}{\rho_i g} \iff p_i = h_i \rho_i g$$

Freshwater head

$$\phi_{f,i} = z_i + \frac{p_i}{\rho_f g} \iff \phi_{f,i} = z_i + \frac{h_i \rho_i}{\rho_f}$$

$$\phi_{f,i} = \frac{\rho_i}{\rho_f} h_{p,i} - \frac{\rho_i - \rho_f}{\rho_f} z_i$$

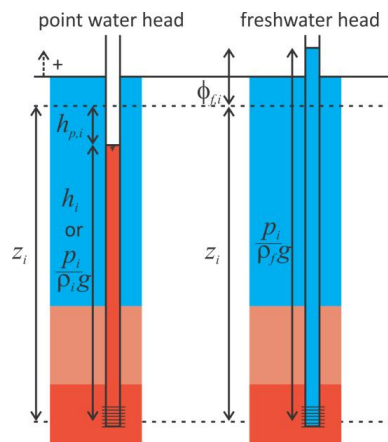

Post, Kooi and Simmons, 2007, Ground Water

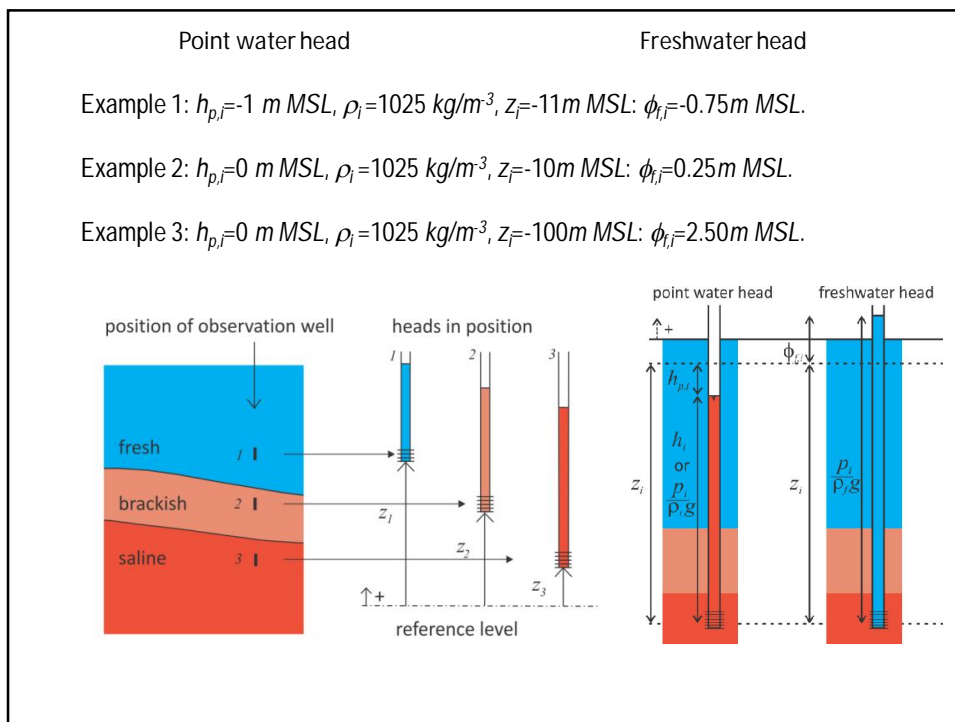
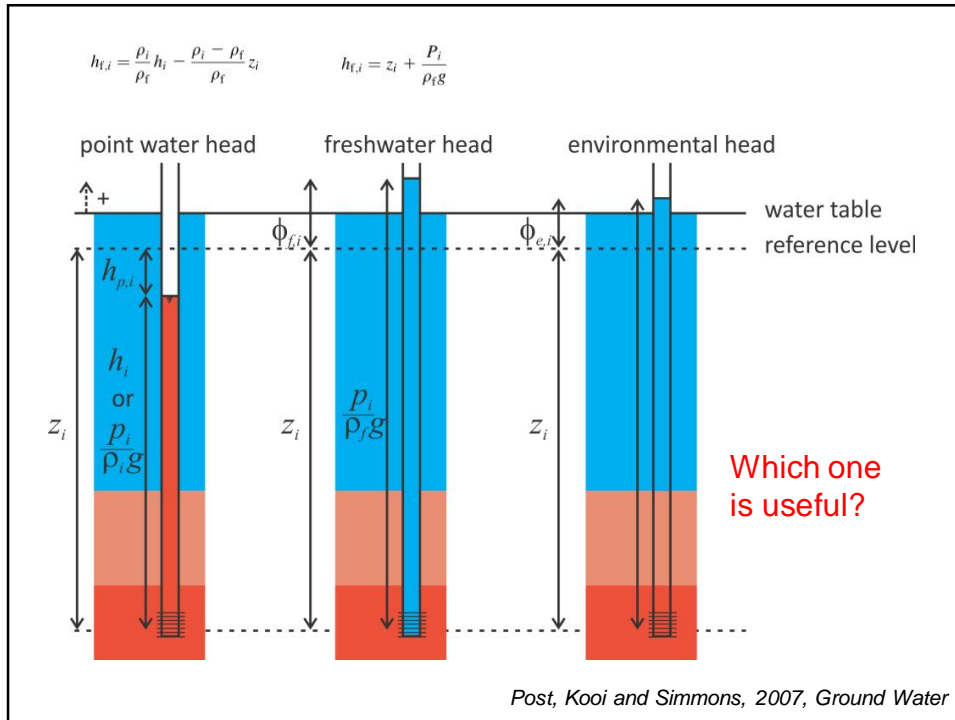

Freshwater head ϕ_f : horizontal flow?

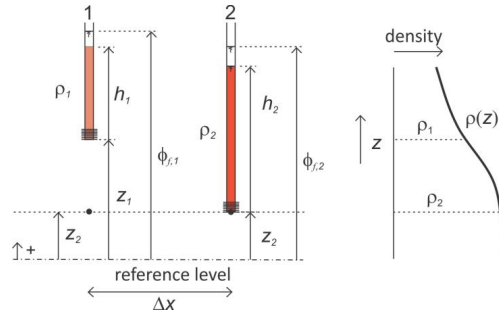

$$p_1^{at\ z=z_2} = \rho_1 g h_1 + \int_{z_2}^{z_1} \rho(z) g dz \quad \phi_{f,1}^{at\ z=z_2} = z_2 + \frac{\rho_1}{\rho_f g} h_1 + \frac{1}{\rho_f g} \int_{z_2}^{z_1} \rho(z) g dz$$

$$p_2^{at\ z=z_2} = \rho_2 g h_2 \quad \phi_{f,2}^{at\ z=z_2} = z_2 + \frac{\rho_2}{\rho_f} h_2$$

$$q^{at\ z=z_2} \cong -k_x \frac{\phi_{f,2}^{at\ z=z_2} - \phi_{f,1}^{at\ z=z_2}}{\Delta x}$$

Freshwater head ϕ_f : vertical flow?

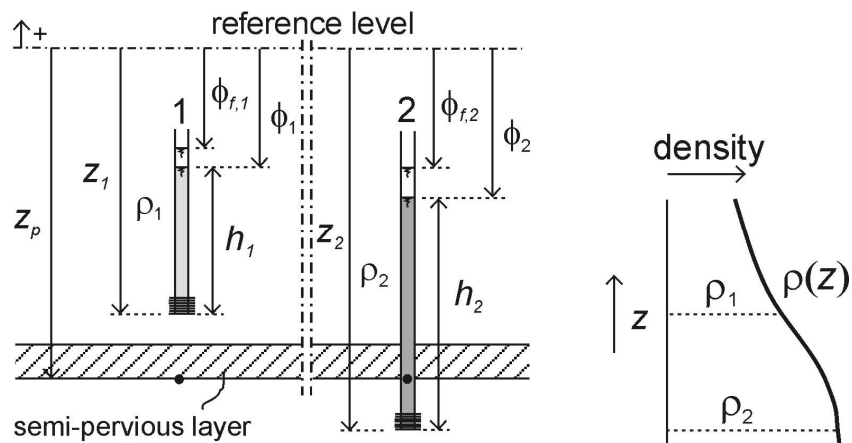

Freshwater head ϕ_f

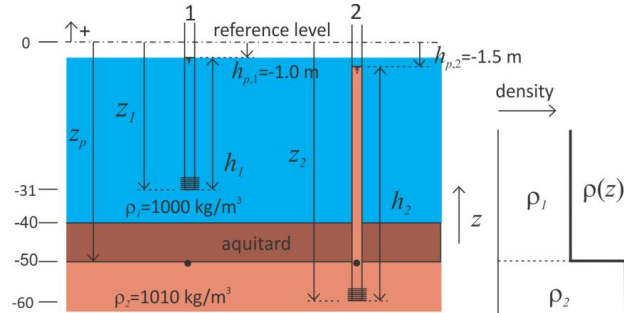

$$\phi_{f,1}^{z=-50} = -50 + \frac{1000}{1000}30 + \frac{1}{1000g} \int_{-50}^{-31} 1000gz dz = -50 + 30 + 19 = -1.0$$

$$\phi_{f,2}^{z=-50} = -50 + \frac{1010}{1000}58.5 - \frac{1}{1000g} \int_{-50}^{-60} 1010gz dz = -50 + 59.085 - 1.01(-50 + 60) = -1.015$$

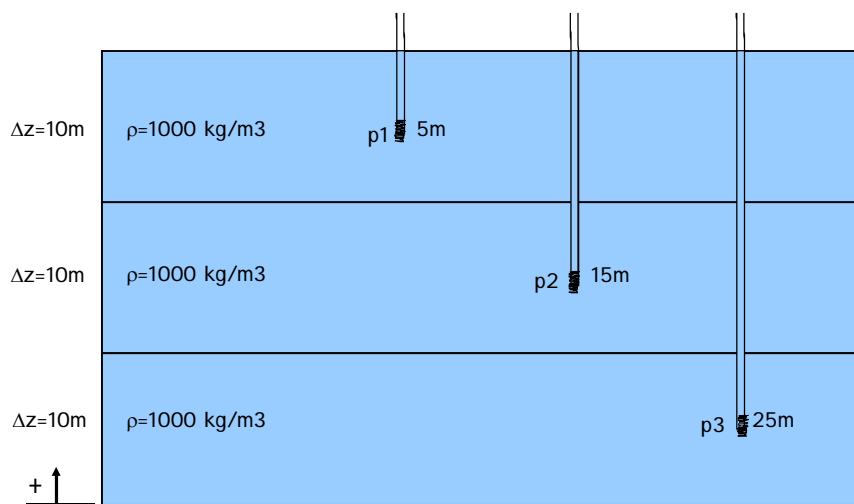

No flow

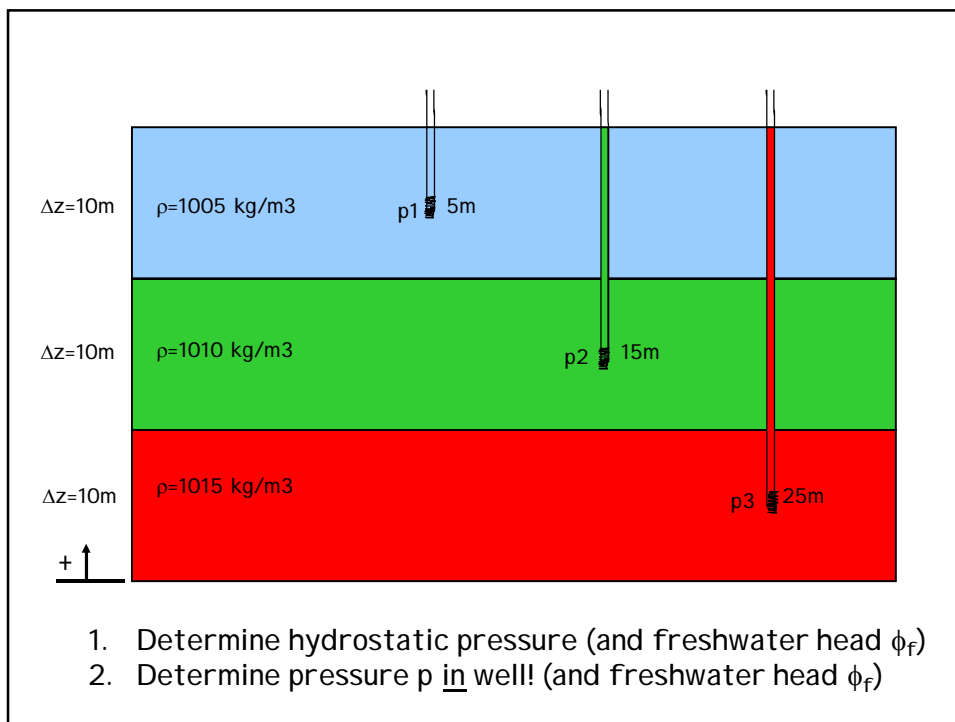
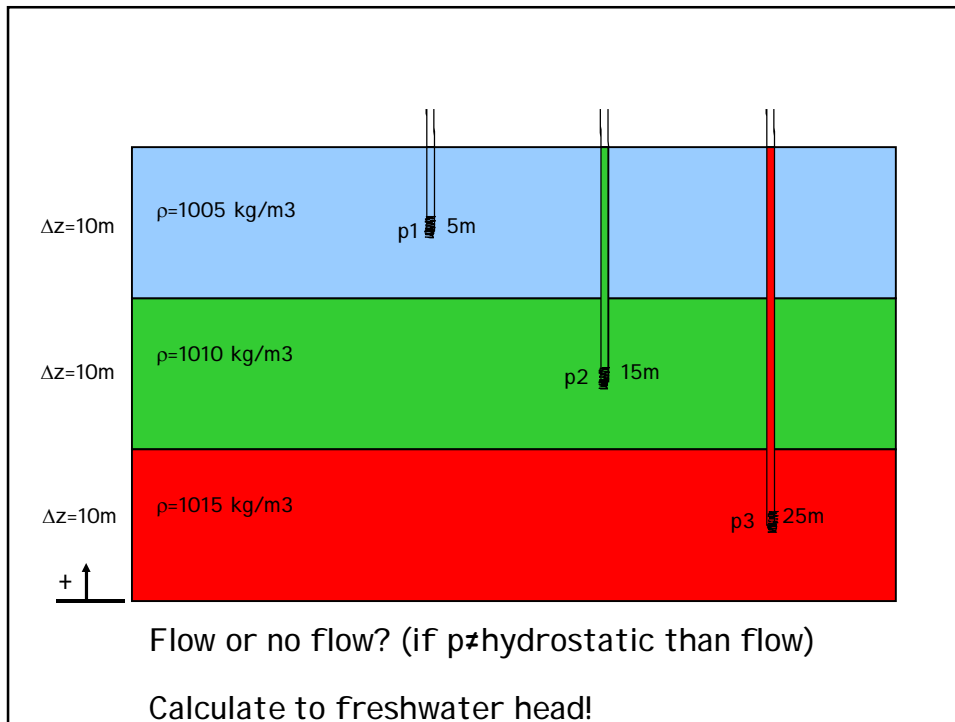

1. Determine hydrostatic pressure and frwhead

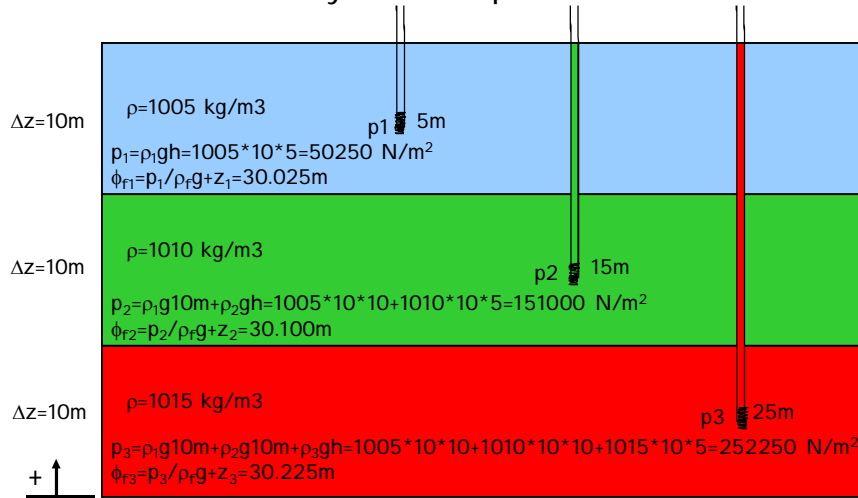

1. Determine hydrostatic pressure (and freshwater head ϕ_f)
2. Determine pressure p in well! (and freshwater head ϕ_f)

2. Determine pressure p in well and frwhead

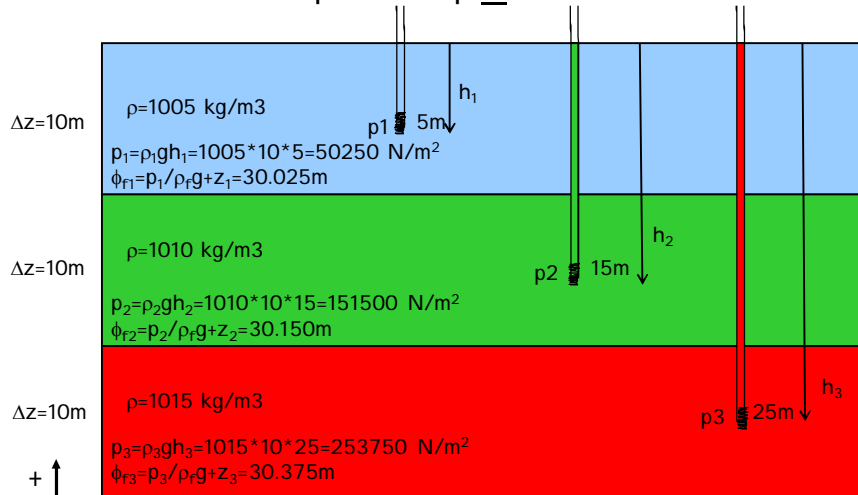

1. Determine hydrostatic pressure (and freshwater head ϕ_f)
2. Determine pressure p in well! (and freshwater head ϕ_f)

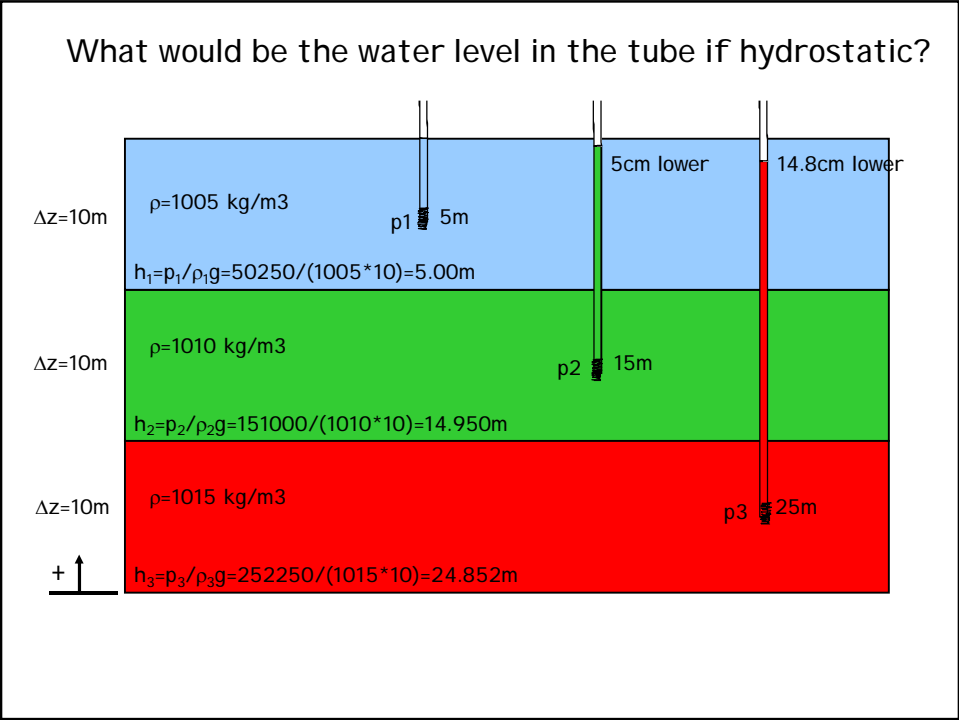
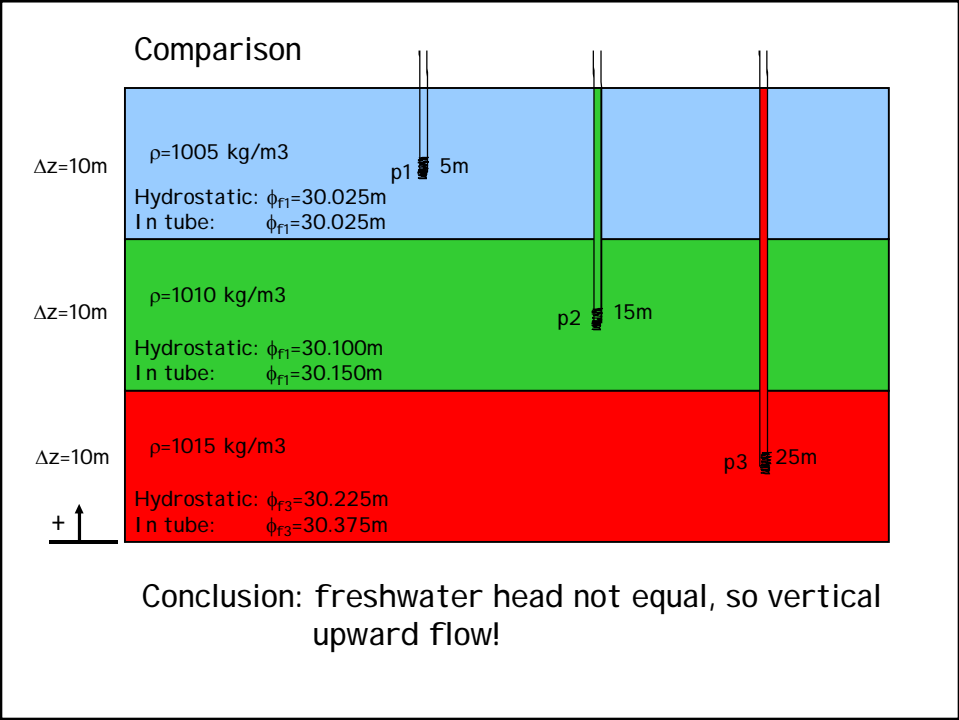

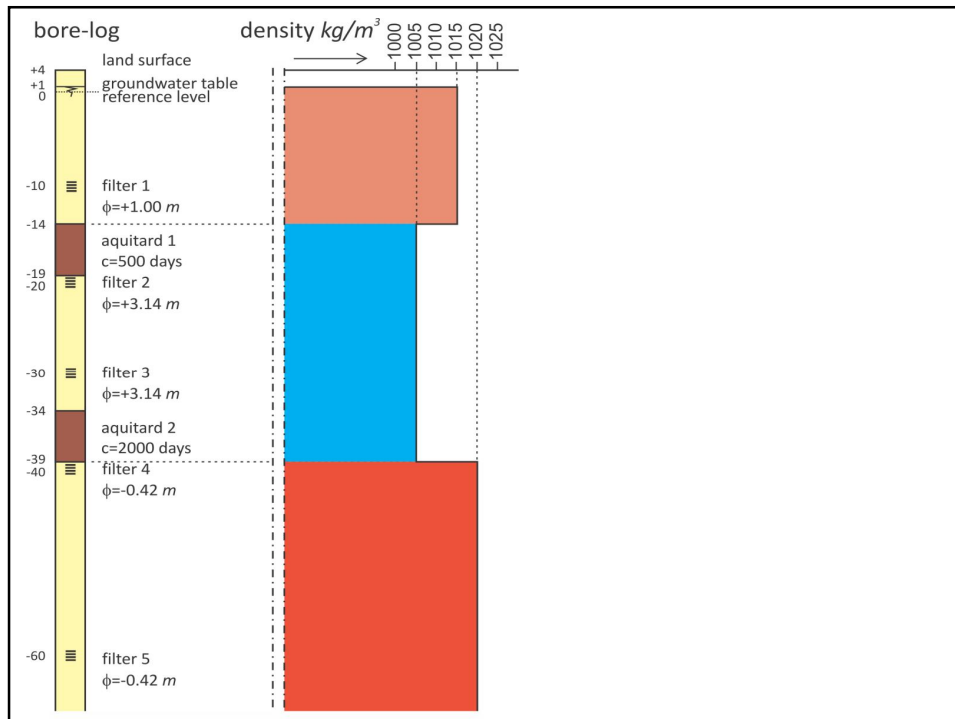

Take home message

1. In coastal area (with fresh-brackish-saline groundwater), always measure head and Electrical Conductivity (EC)
2. Convert EC to density
3. Determine freshwater head with lecture notes and ppt
4. Determine flow

Monitoring

Different (fresh-salt) monitoring techniques

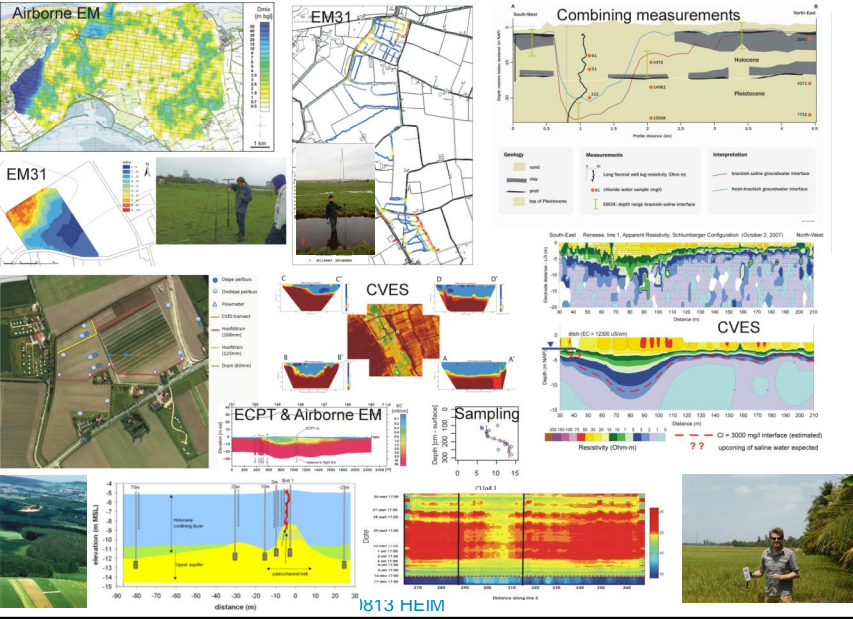

Monitoring salt in groundwater

- Why monitoring?
 - Mapping salt concentrations in the groundwater
 - Detection of trends (upconing near pumping stations)
 - System and process knowledge
 - Input for a groundwater model

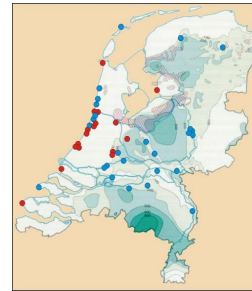

- Methods:
 1. Direct: water sample available
 2. Indirect: conductance of the subsoil

- Pumping stations with salinisation
- Pumping stations closed due to salinisation

Source: V. Post, 2007

EC and Chloride

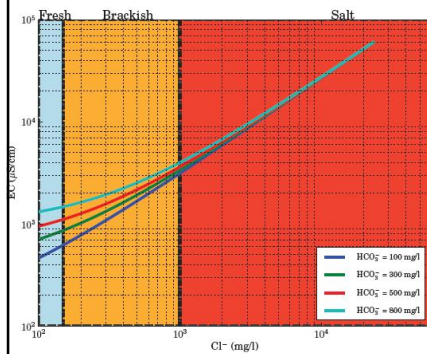

EC-Cl at different HCO_3^- concentrations.

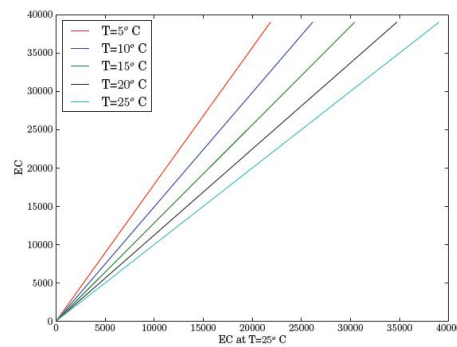

(b) EC and temperature standardized EC.

P. Pauw, 2009

20120622 SWIM22

EC and Chloride

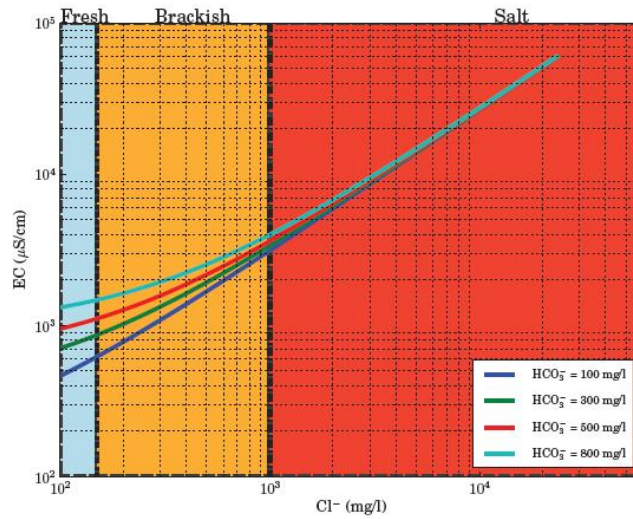

201206 EC-Cl at different HCO_3^- concentrations.

EC and Chloride

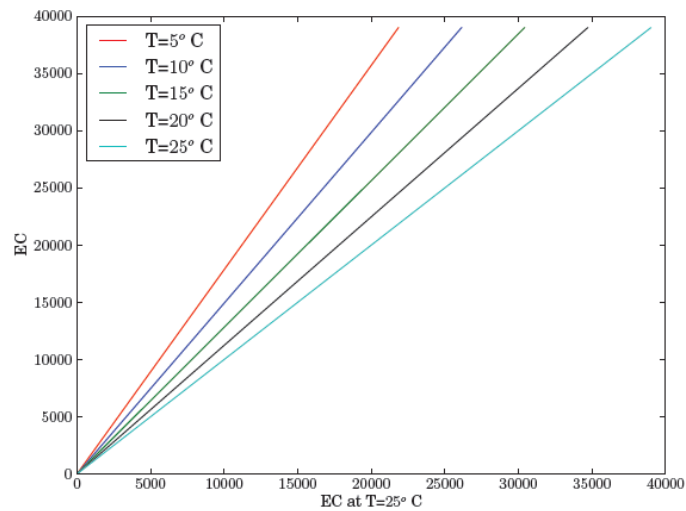

21 (b) EC and temperature standardized EC.

Airborne measurements

Measuring system	Physical parameter	Geology/terrain information
radar	EM traveltime	Terrain elevation
Infrared photography	Infrared radiation	Surface temperature
Time domain EM Frequency domain EM	Electr. resistivity from induced EM fields	Lithology Water salinity
Magnetic gradiometer	Magnetic field (variations)	Lithology (magnetite) Artefacts Steel/Iron objects
Spectral gamma	Radiation (gamma)	Soil type Surface lithology Recent disturbance

Source: Koos Groen

Surface measurements

Measuring system	Physical parameter	Geology/terrain information
Ground penetrating radar	EM traveltime, dielectric constant,	Lithology Soil moisture
ERT	Electr. resistivity	Lithology Water salinity
Time domain EM Frequency domain EM	Electr. resistivity	Lithology Water salinity
Magnetometer (total field, gradiometer)	Magnetic field (variations) magnetic susceptibility	Lithology (magnetite) Artefacts Steel/Iron objects (UXO)
Spectral gamma	Radiation (gamma)	Soil type Surface lithology Recent disturbance

Source: Koos Groen

Cone Penetration Tests

Measuring system	Physical parameter	Geology/terrain information
mechanical CPT	Cone resistance Friction resistance	Lithology Geotechnical parameters
Electrical conductivity	Electrical formation conductivity	Water salinity
Continuous water pressure	Water pressure	Lithology Piezometric head
Water pressure dissipation in clay layers	Water pressure in time	Permeability clays
BAT sampling in CPT casing		Water chemistry
ROST, MIP		Contamination of hydrocarbons (high concentration)
Camera sonde	Visual view	Lithology, contamination, gas

Source: Koos Groen

Monitoring salt in groundwater: Direct methods

Method	Advantage	Disadvantage
1. Observation well	<ul style="list-style-type: none"> •High accuracy •Detection trends 	<ul style="list-style-type: none"> •Costly •Point measurement
2. Well screens in observation well	<ul style="list-style-type: none"> •High accuracy •Detection trends •High vertical resolution 	<ul style="list-style-type: none"> •Costly
3. Sediment sample (extraction milliliters of water)	<ul style="list-style-type: none"> •High accuracy •High vertical resolution 	<ul style="list-style-type: none"> •Very costly and time consuming



Direct methods 1 and 2

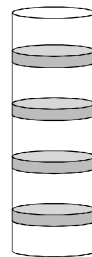

Source: V. Post, 2007

Monitoring salt in groundwater: Indirect methods

Indirect methods measure the **conductance** of:

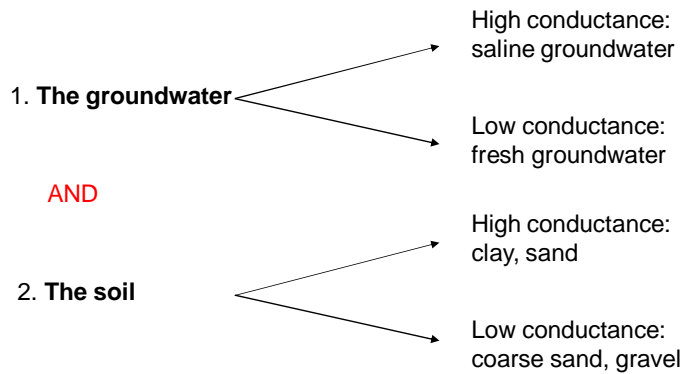

Hence information about the lithology (sand, clay etc) is needed!

Source: V. Post, 2007

Monitoring salt in groundwater: Indirect methods

Method	Advantages	Disadvantages
1. Electrical conductance measurements	<ul style="list-style-type: none"> •High resolution (3D) •Depth ~200 m 	<ul style="list-style-type: none"> •Time consuming
2. Electromagnetic measurements	<ul style="list-style-type: none"> •Fast 	<ul style="list-style-type: none"> •Limited vertical resolution •Sensitive for underground conductors (pipes)
3. Satellites	<ul style="list-style-type: none"> •Suitable for large areas 	<ul style="list-style-type: none"> •Small vertical resolution •Low accuracy

Source: V. Post, 2007

Method used at Deltares

Number of measurements bottom Holocene top layer :
direct methods and Vertical Electric Soundings (VES)

- Combination of:
- Direct measurements
 - Electrical conductance measurements
 - Surface (VES)
 - Borehole

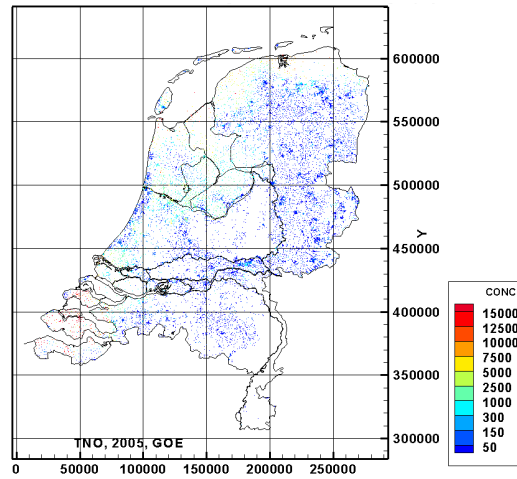

Source: Oude Essink et al (2005)

Electrical conductance measurements

1. Measuring:

- **Inside a borehole**
- From surface level
- From the air



Source: TNO

Source: V. Post, 2007

Electrical conductance measurements

1. Measuring:

- Inside a borehole
- **From surface level (depth ~ 200 m)**
- From the air



Source: V. Post, 2007



Source: Vitens

Principle geo-elektrical measurement

I: currentelektrode, V: potentialelektrodes, Ra: appearant elektrical resistiuivity

$$Ra = \text{constant} * V/I$$

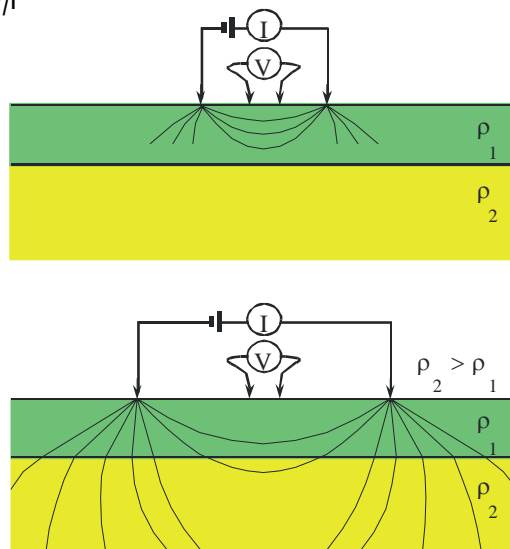

20120622 SWIM22

Types geo-electrical measurements

- I Vertical Electrical Sounding (VES)
- 4 elektrodes at surface
- 1D elektrical resistivity profile
- Labor intense
- Accurate, great depths
- Deep hydrogeology

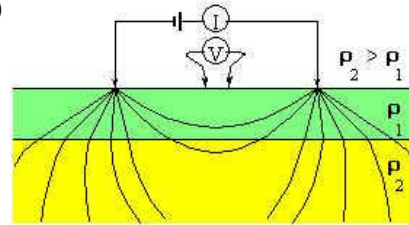

- II Continue Vertical Elektrical Sounding (CVES)
- >80 elektrodes at surface
- 2D elektrical resistivity subsurface
- Limited depth (~30 m)

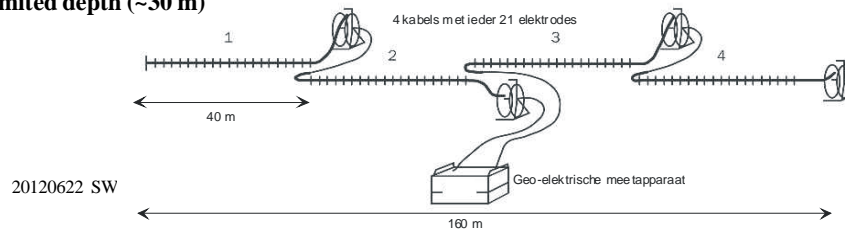

VES measurement end 1950s/begin 1960s



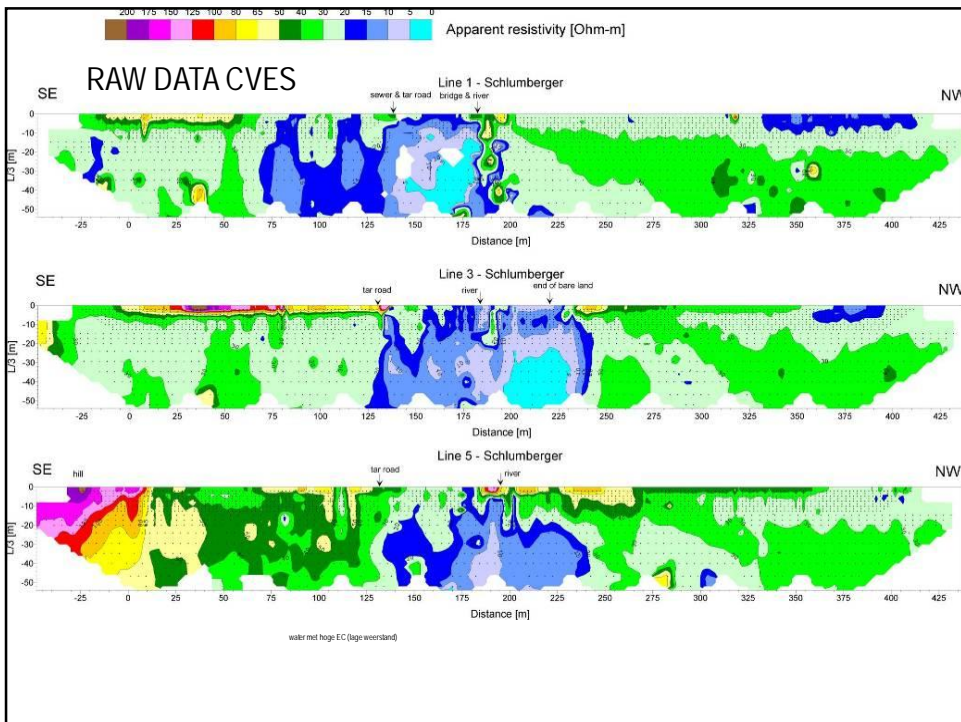

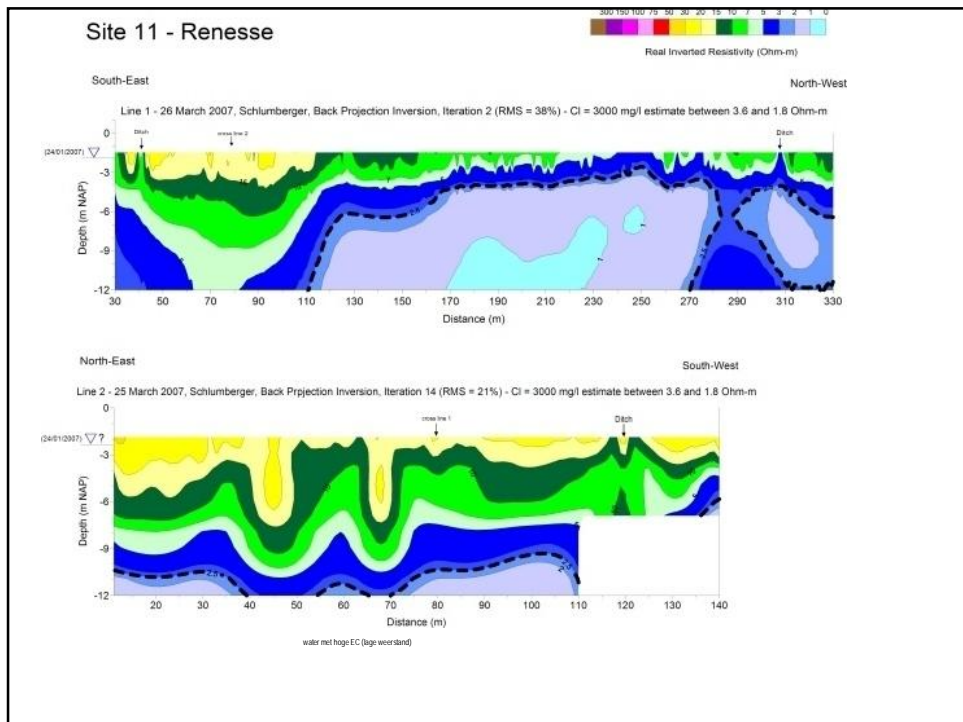
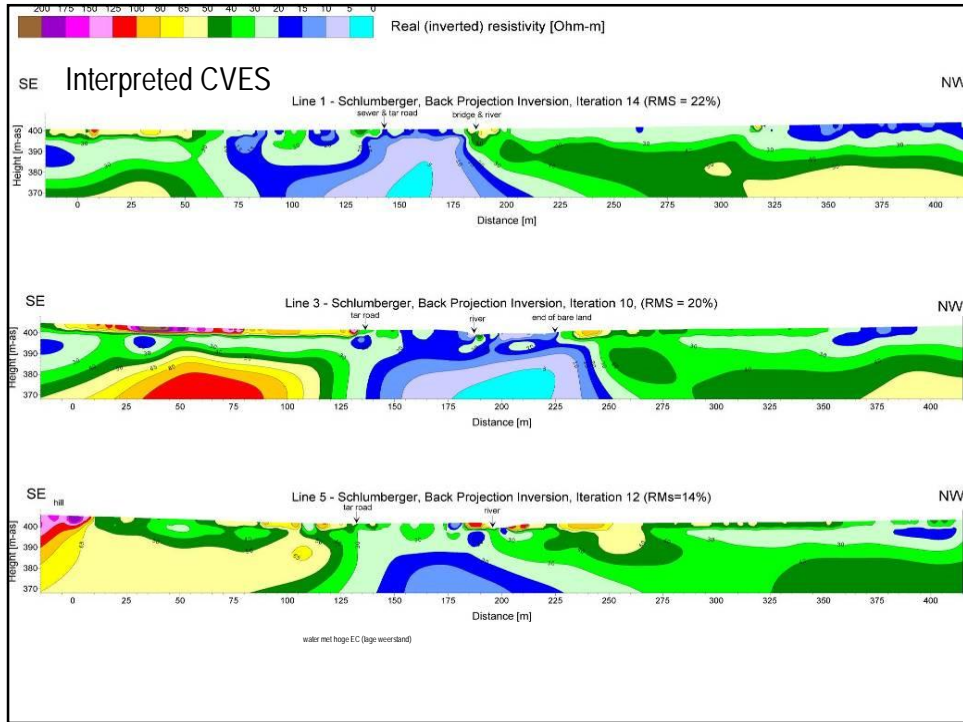

Possible measures for sandy creeks

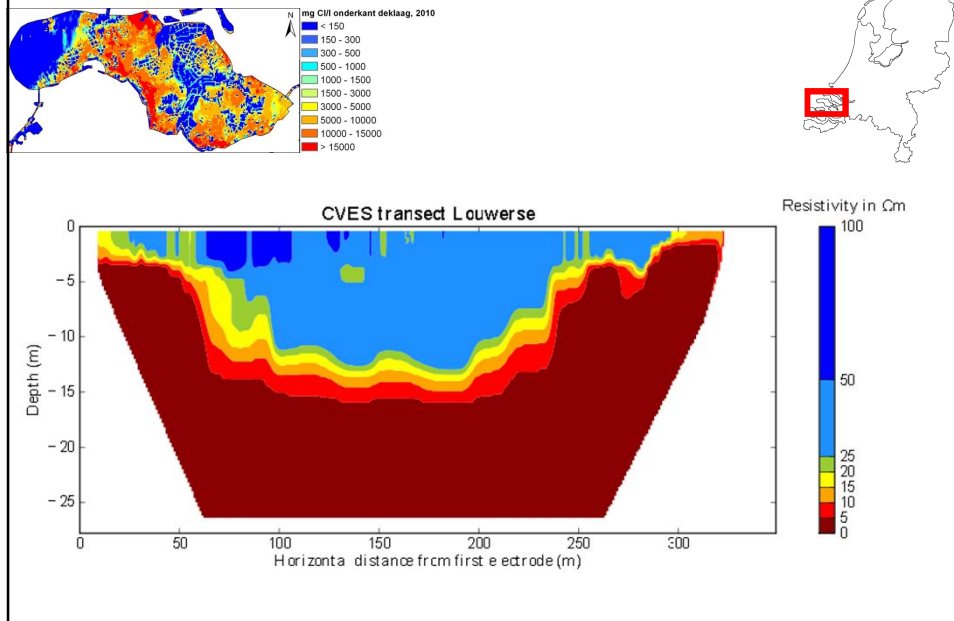

Monitoring salt in groundwater: Indirect methods

- Electrical conductance measurements

$$\rho_s = F \cdot \rho_w$$

ρ_s = resistance subsoil & groundwater

ρ_w = resistance groundwater

F = formation factor

Lithology	F
Gravel with sand	7
Coarse sand	5
Sand with silt	2 - 3
Clay	1-3*
peat	1*

F varies with the resistance of the groundwater

If the lithology is known AND the measurement is in an aquifer
 $\rightarrow \rho_w$ can be calculated

VES measurements are used in combination with borehole logging

Source: Oude Essink, 2005

Result: chloride concentration bottom Holocene toplayer

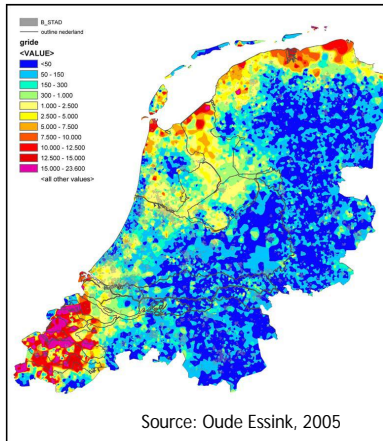

- Software Geological Survey of the Netherlands (TNO) is used to determine the salt concentration of the groundwater in the measurements
- Inter- and extrapolation is used to make a continuous field
- 2D Result is a combination of:
 1. Direct measurements (3500)
 2. Electrical conductance in boreholes (2000)
 3. Vertical Electric Sounding (VES) measurements (10.000)

T-EC probe

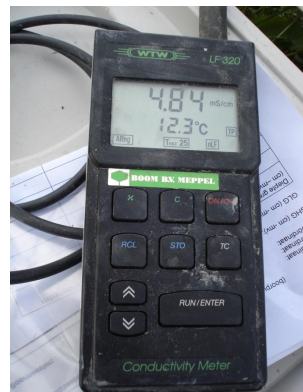

T EC fieldwork

Altitude measurements



Use field measurements to understand the process

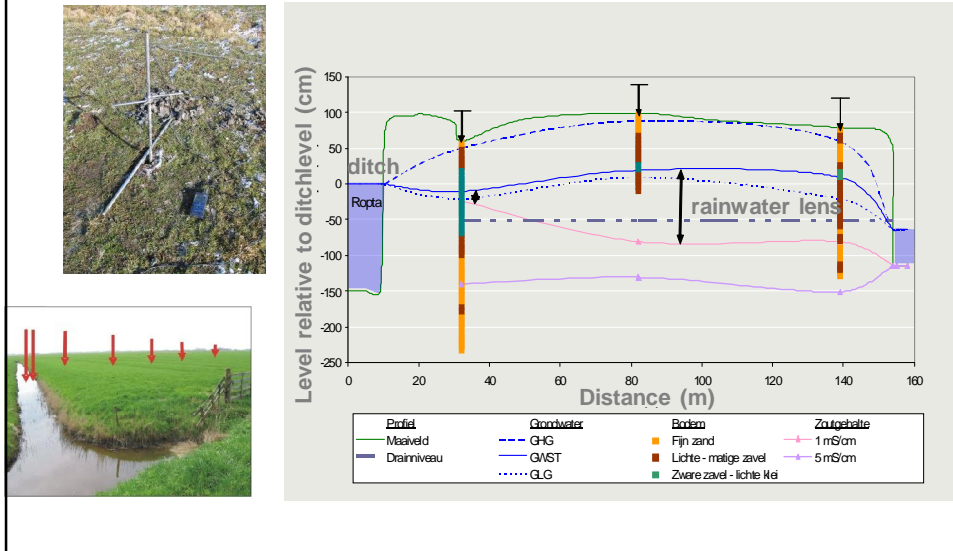

TEC-probe Monitoring campaign 2005-2009

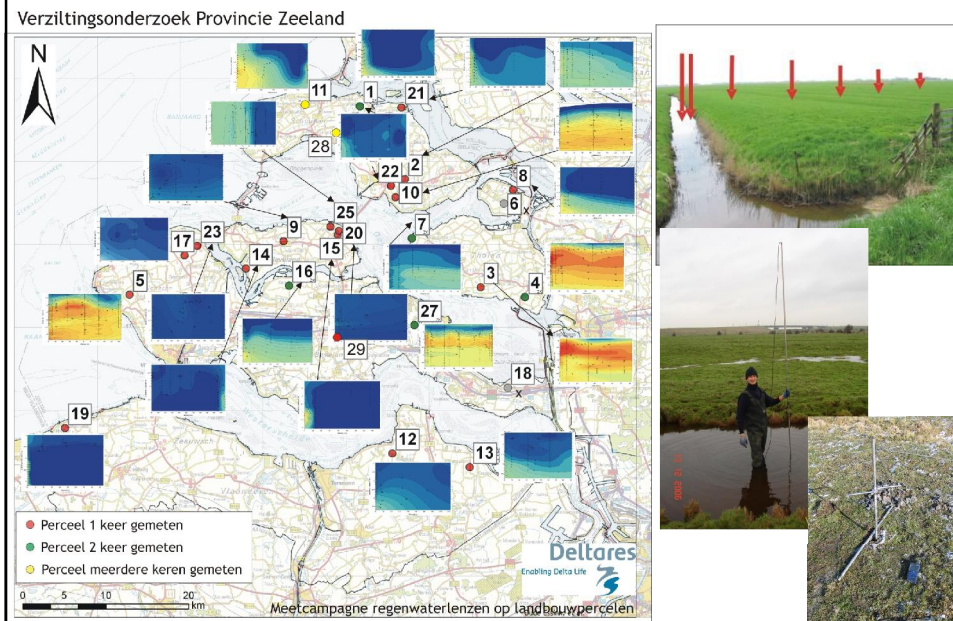

CliWat www.cliwat.eu

- Transnational project in the North Sea Region
- Main objectives:
 - to evaluate the physical and chemical impacts of climate change on groundwater and surface water systems
 - to provide data for adaptive and sustainable water management and infrastructure.
- Different innovative monitoring techniques (Helicopter EM, CVES, CPT, TEC-probe) are used to map the salinization status of the coastal groundwater system.



Description local area

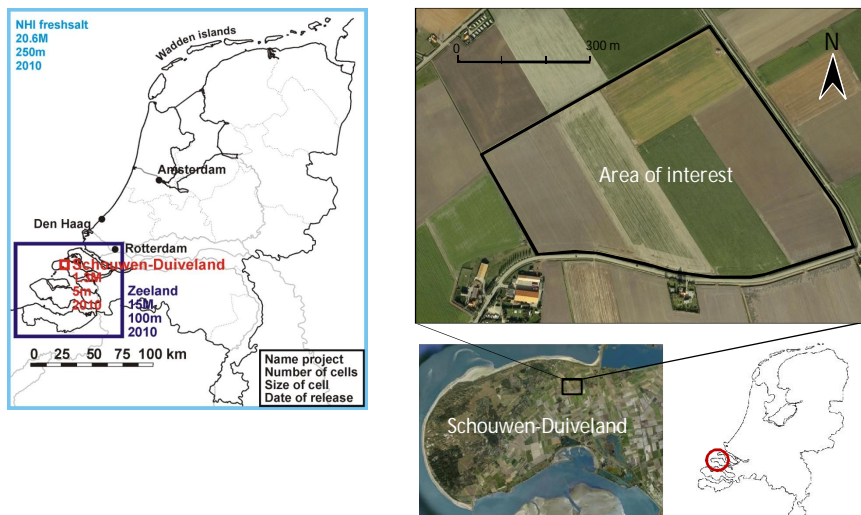

Monitoring network in our Pilot Area Zeeland

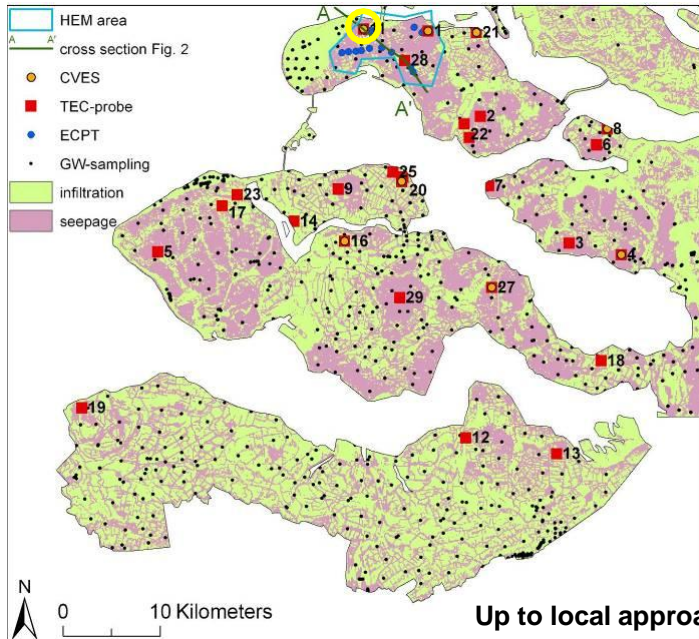

Up to local approach

Example: Assessing effect of climate change on salt water intrusion

Monitoring:

- piezometric head and solute concentration
- TEC probes, CVES
- online

Source: Oude Essink, 2009

TEC probe

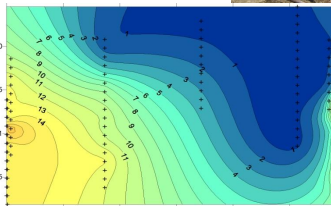

Site 11 - Renesse

CVES

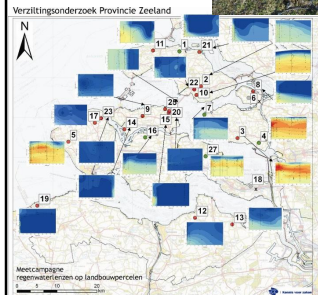
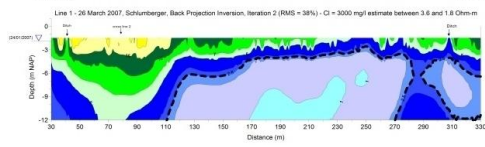

Site 11: from infiltration to seepage

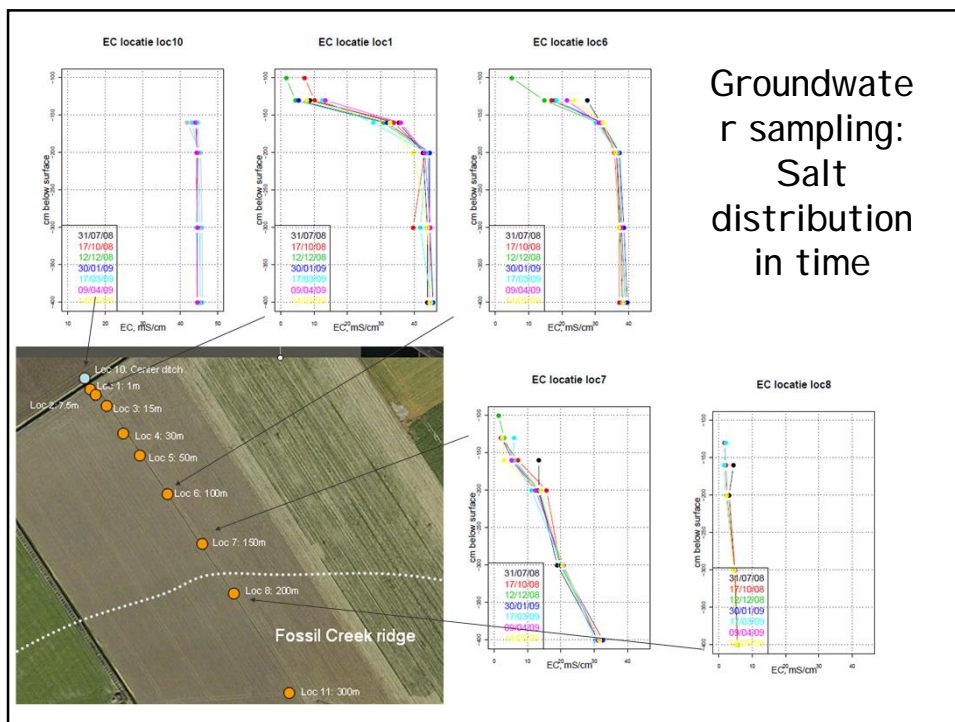
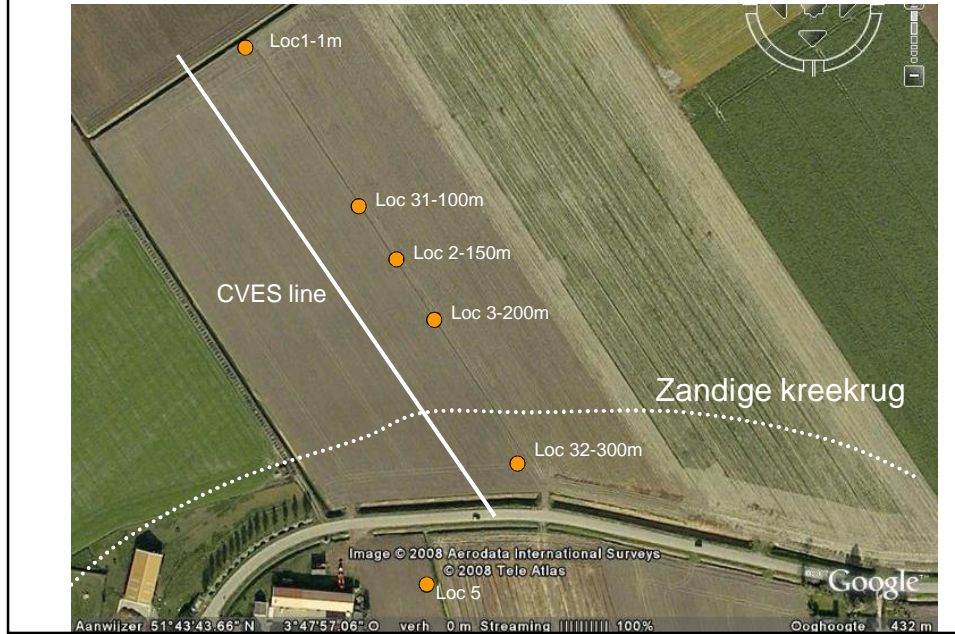

Factors controlling fresh-salt interface

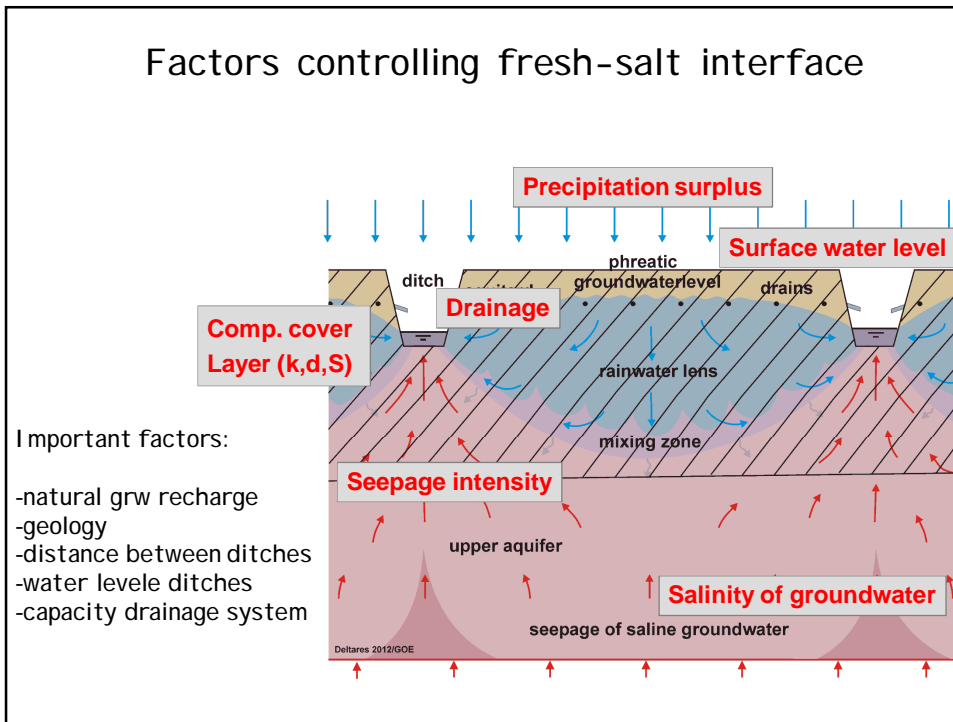

Lens characteristics

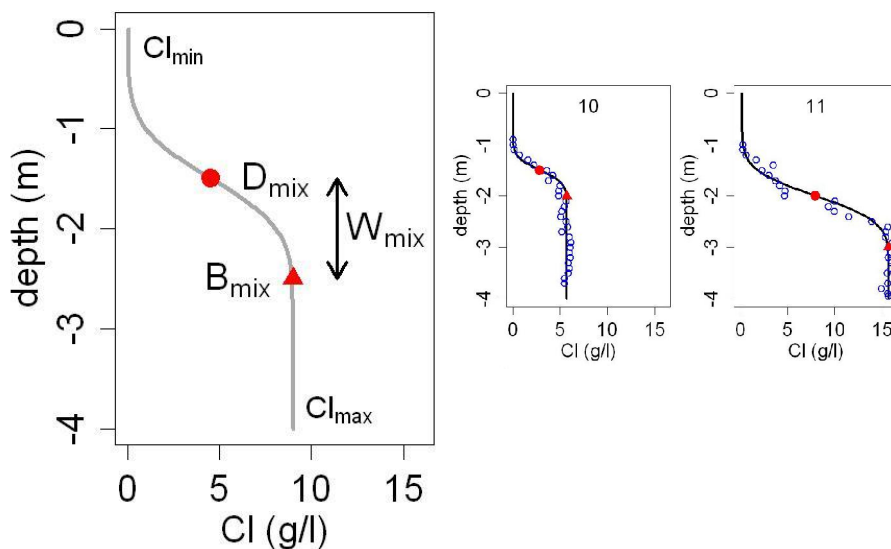

Louw, P.G.B., de Eeman, S., Siemon, B., Voortman, B.R., Gunnink, J., Baaren, E.S., van and G.H.P. Oude Essink, Shallow rainwater lenses in deltaic areas with saline seepage, *Hydrol. Earth Syst. Sci. Discuss.*, 8, 7657-7707, 2011.

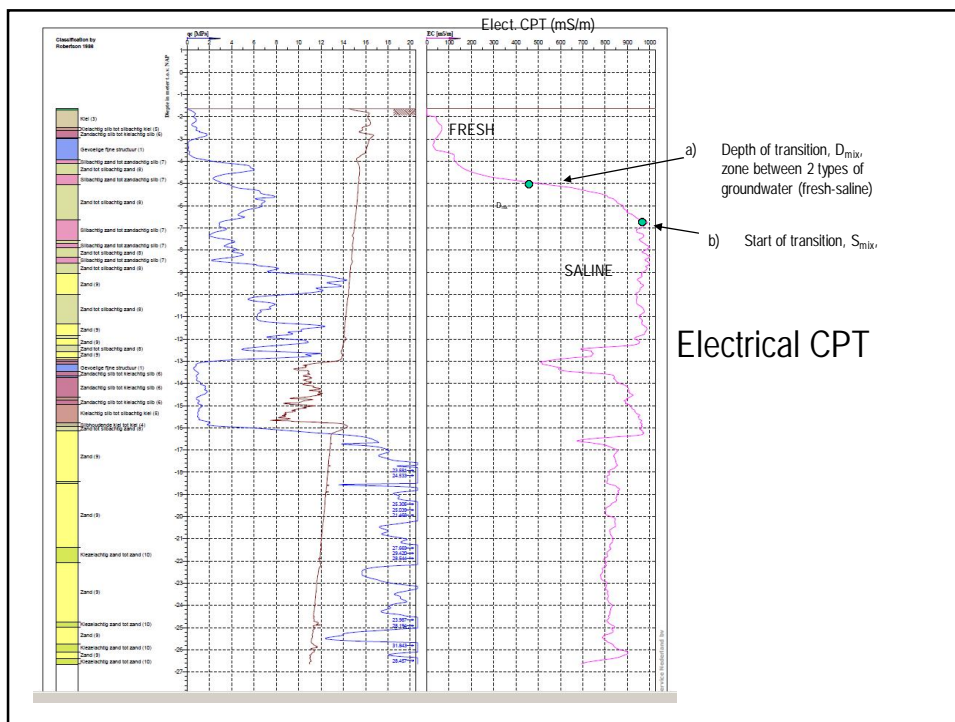
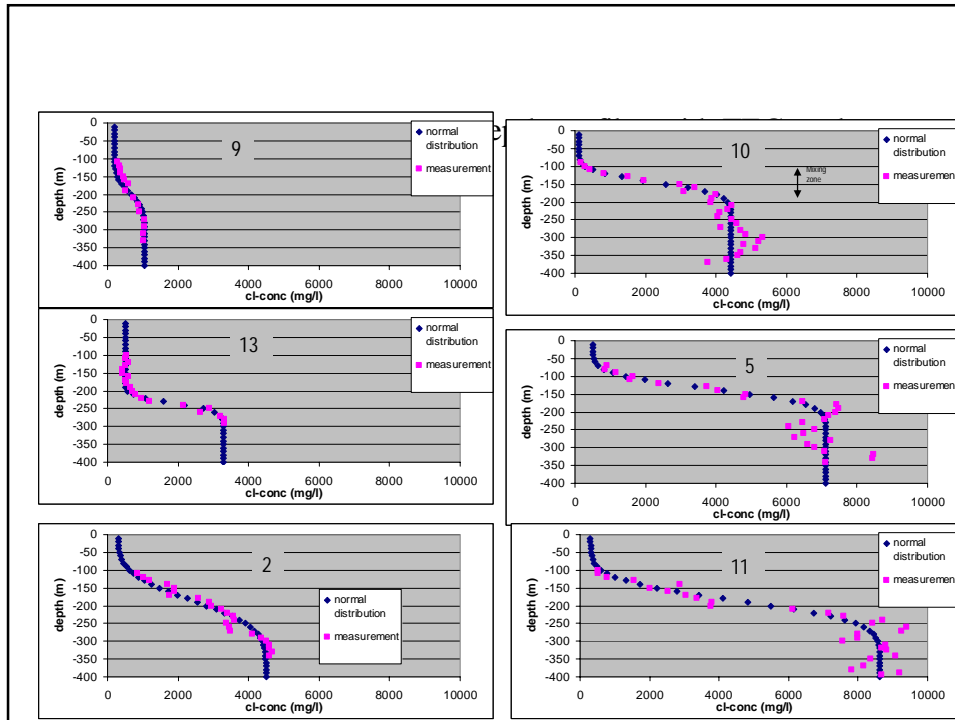

Results from ECPT's (soundings)

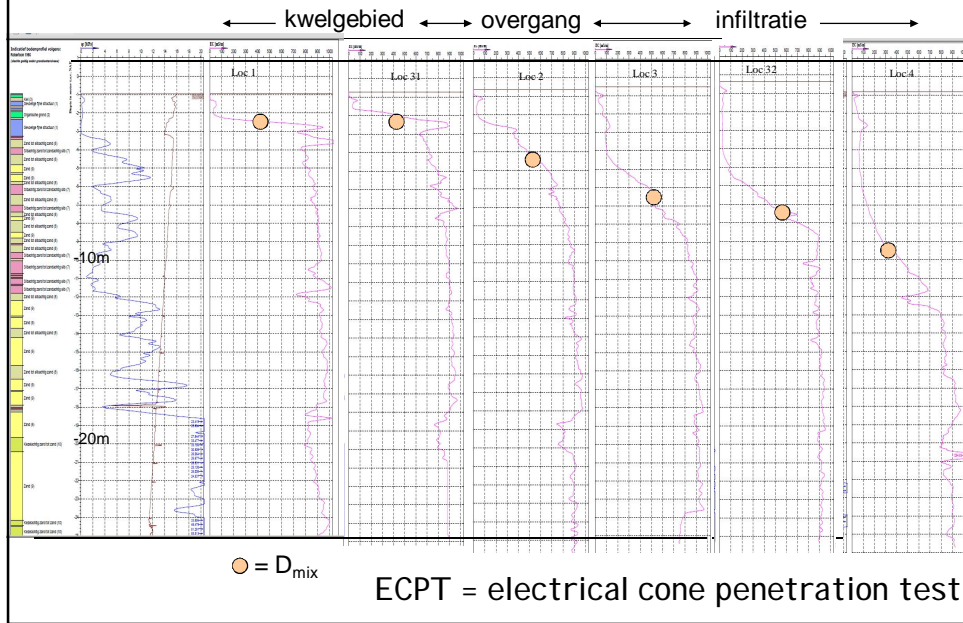

CVES

CVES: continuous vertical electrical sounding

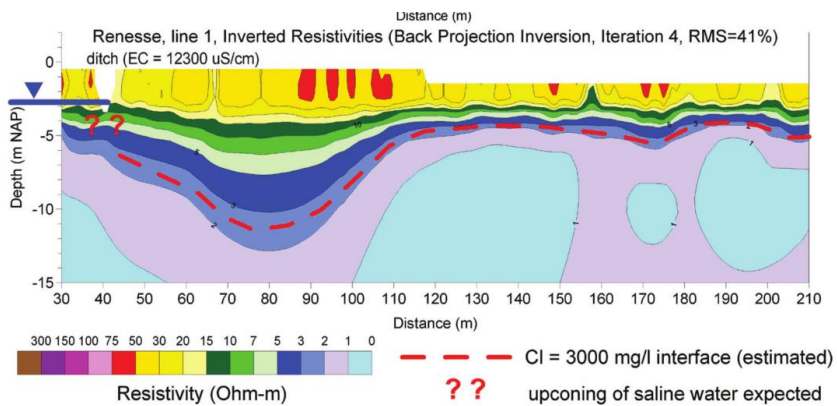

Seepage / infiltration determines thickness rainwater lens

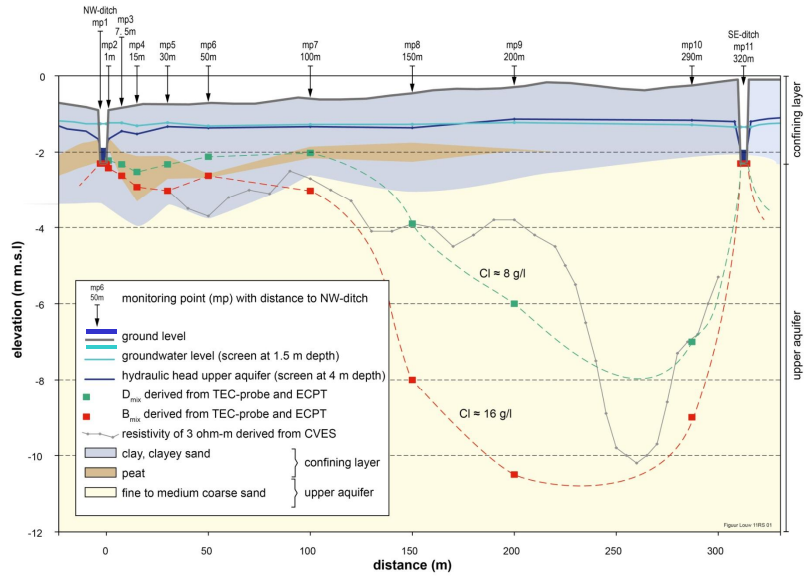

TEC-probe results

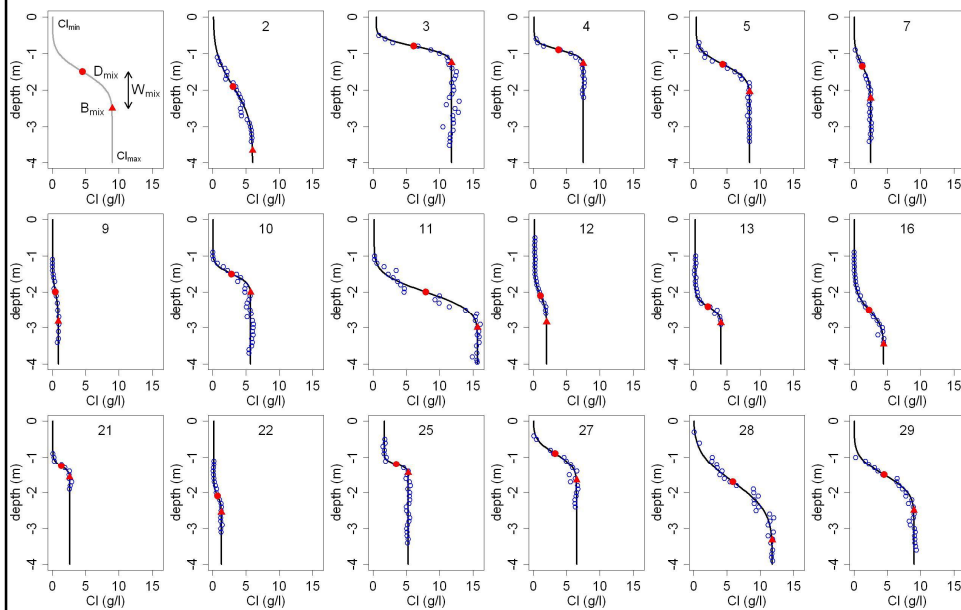

Electrical conductance measurements



10 juni 2013

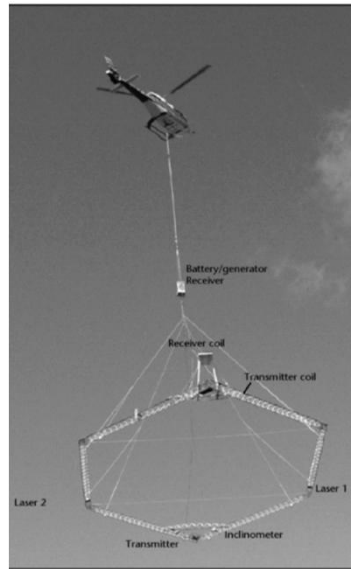

From bulk to groundwater resistivity



EC^{bulk}

EC lithology

EC groundwater
→ fresh-brackish-saline

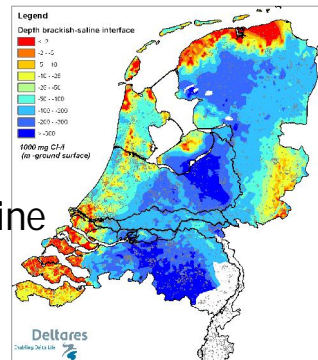
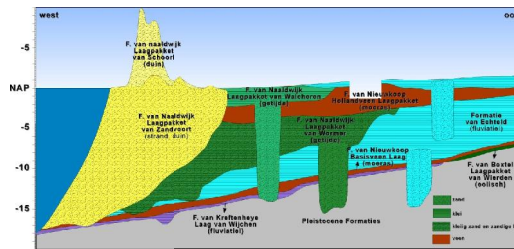

EC = Electrical Conductivity = conductivity

BGR helicopter-borne geophysical system

Airborne geophysical survey system	
Helicopter:	Sikorsky S-76B
Helicopter equipment:	GPS-Navigation GPS-Tracking Radar and barometric altimeters Video camera
Standard equipment:	Electromagnetic system Magnetometer Laser altimeter Gamma-ray spectrometer
Optional equipment:	Laser scanner Pulse radar <i>Stepped frequency</i> - Radar Gravimeter Differential GPS Photogrammetric camera Infrared camera
Base station equipment:	Magnetic total field sensor Air pressure sensor Differential GPS
Survey speed:	130 – 160 km/h
Sampling distance:	~ 4 and 40 m
Line separation	50 – 2000 m

Meeting in Utrecht Feb. 25th 2014

BGR helicopter-borne geophysical system

Recent six-frequency HEM system		
Type:	RESOLVE – Digital system Modified BKS36a DSP and BKS60 DSP systems	
Length:	~ 10 m	
Weight:	~ 400 kg incl. cable (80 kg)	
Manufacturer:	Fugro Airborne Systems, Canada	
Frequency [Hz]	Coil separation[m]	Geometry
387	7.94	horizontal coplanar
1820	7.93	horizontal coplanar
5500	9.06	vertical coaxial
8225	7.93	horizontal coplanar
41550	7.91	horizontal coplanar
133200	7.92	horizontal coplanar

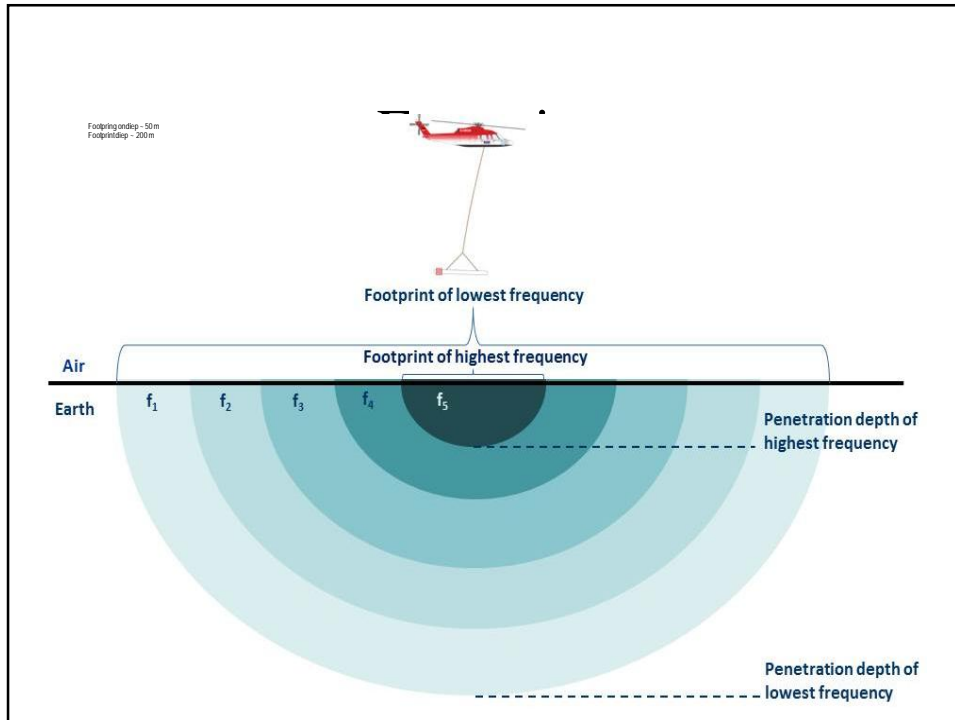

Typical resistivities / conductivities

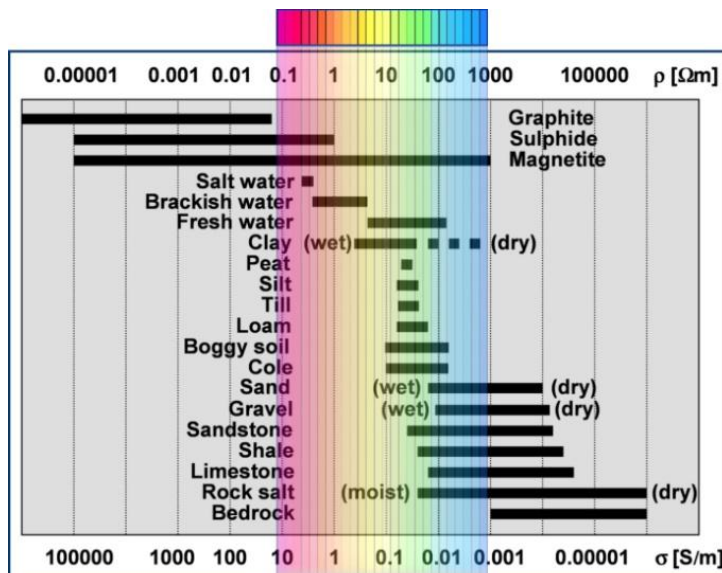

Case Wetterskip Fryslân

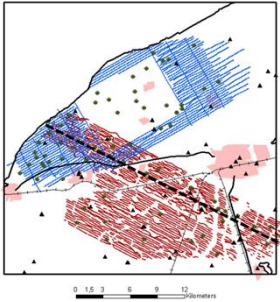

Legend

- ECPT
- ▲ CI measurements
- HEM
- skyTEM
- Geological cross-section

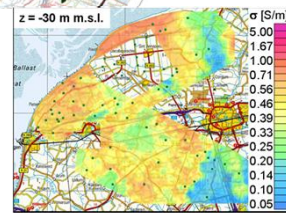
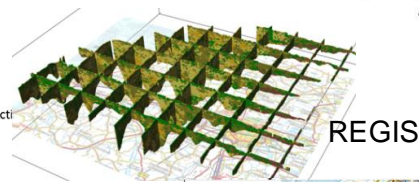

3D fresh-saline distribution

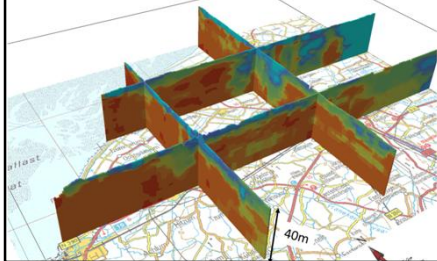

Cl [g/L]



Case Schouwen-Duiveland

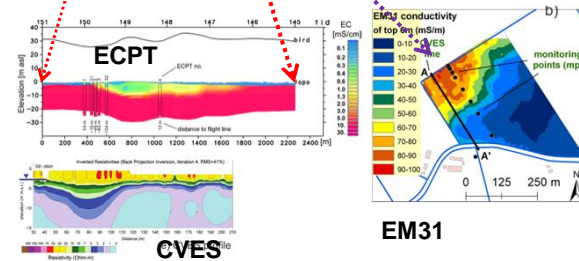
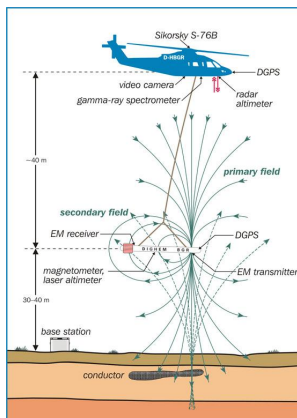
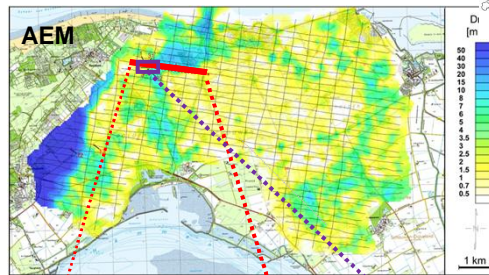

CVES^{le}

EM31

conventional monitoring techniques

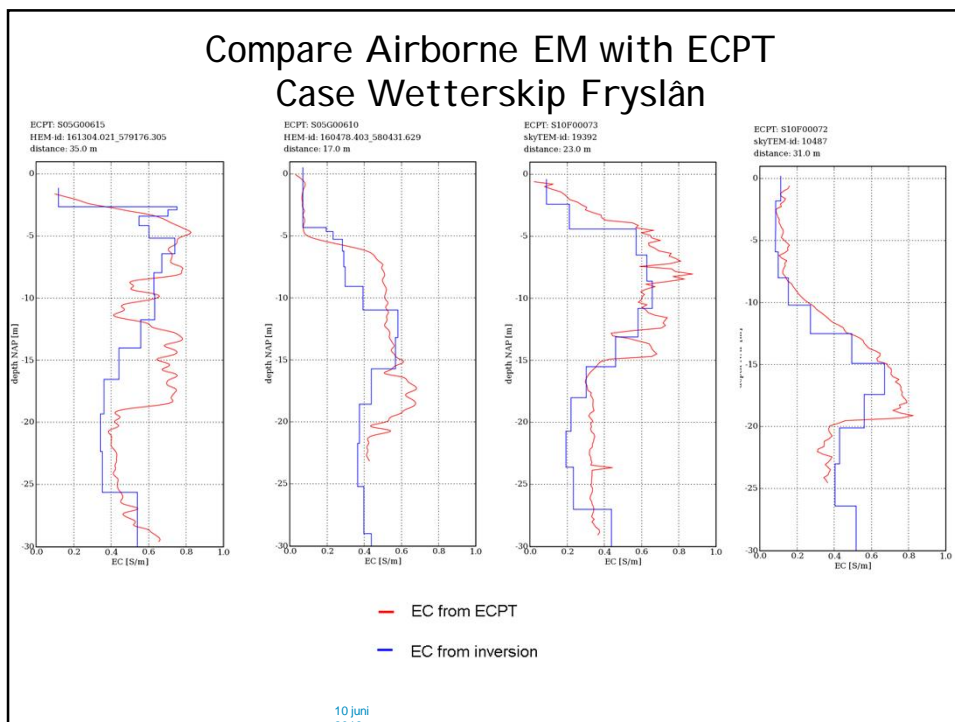
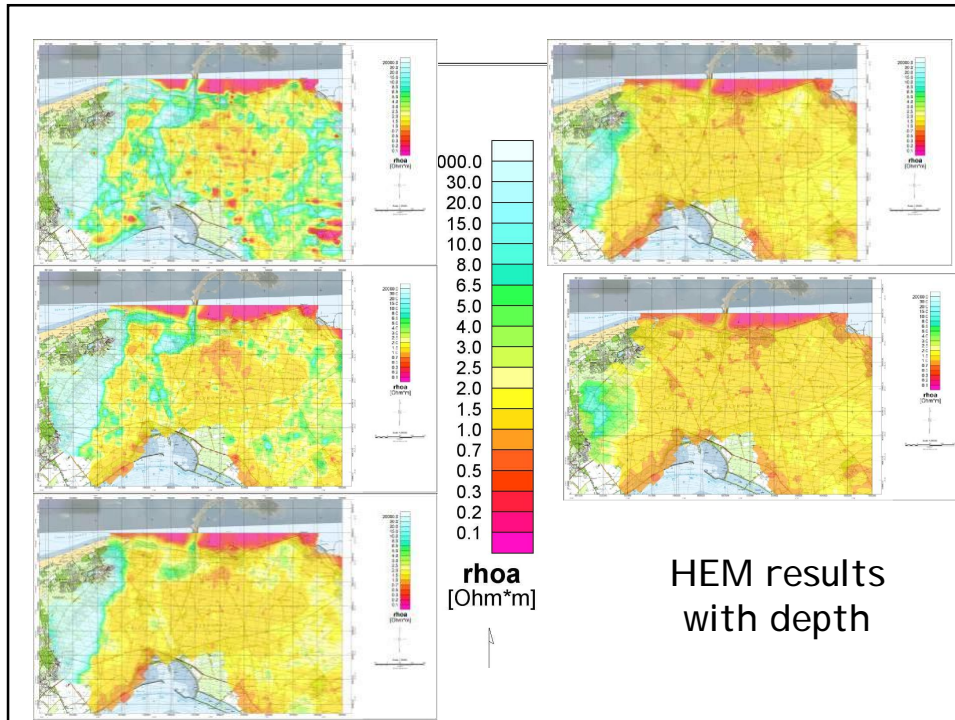

3D characterising fresh-saline groundwater

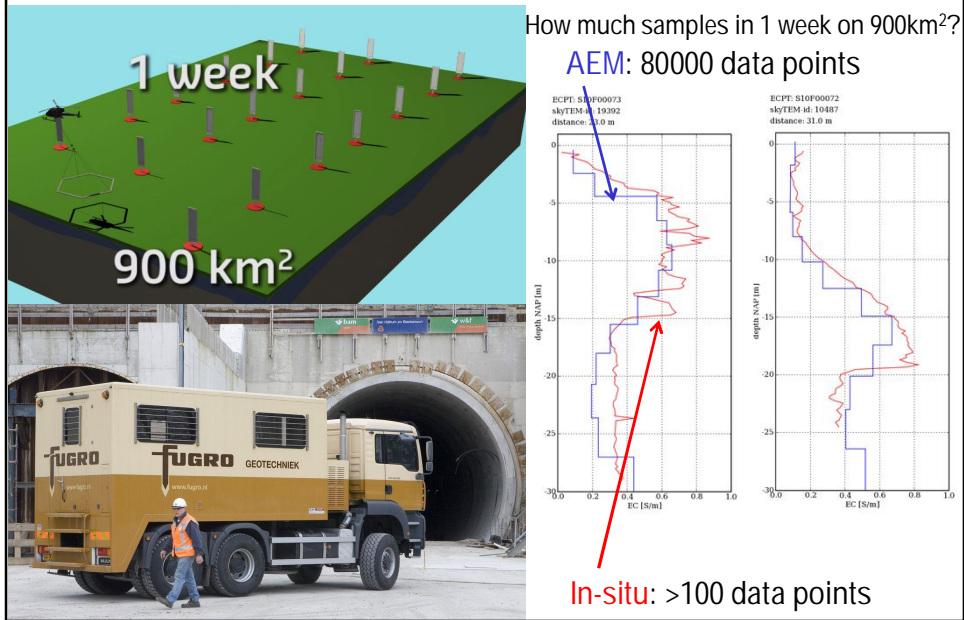

3D Characterisation of the subsoil

Airborne EM surveys:
 much cheaper, faster, 3D,
 and as equal accurate as
 conventional geophysical methods

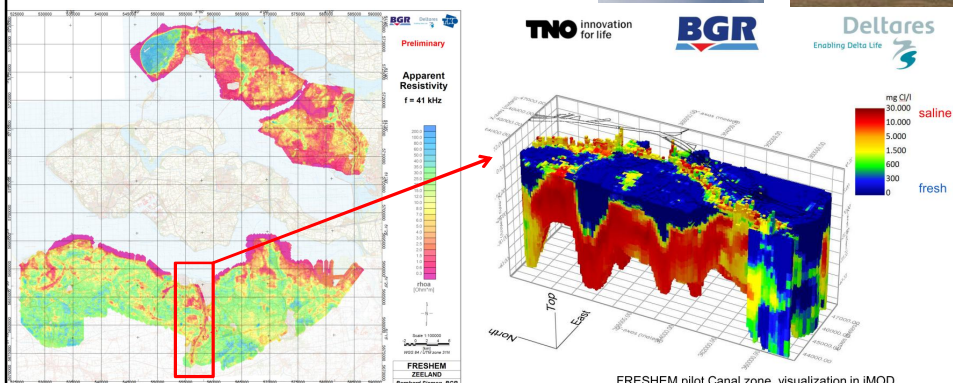

Example NL, Zeeland, project FRESHEM

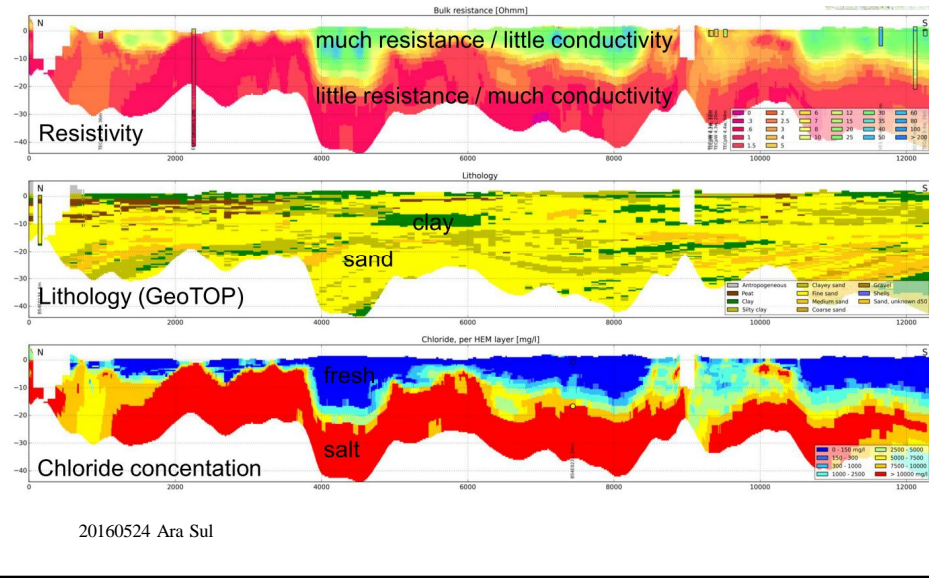

Combining monitoring techniques

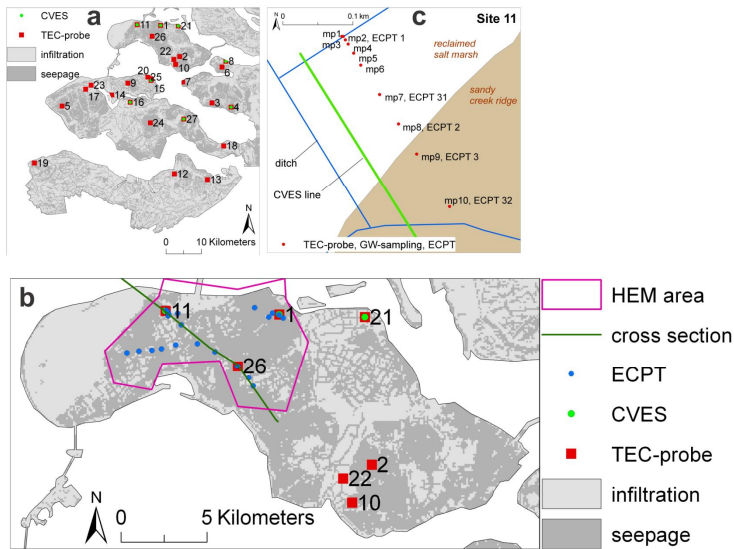

10 juni 2013

Helicopter-EM data for mapping fresh-saline groundwater

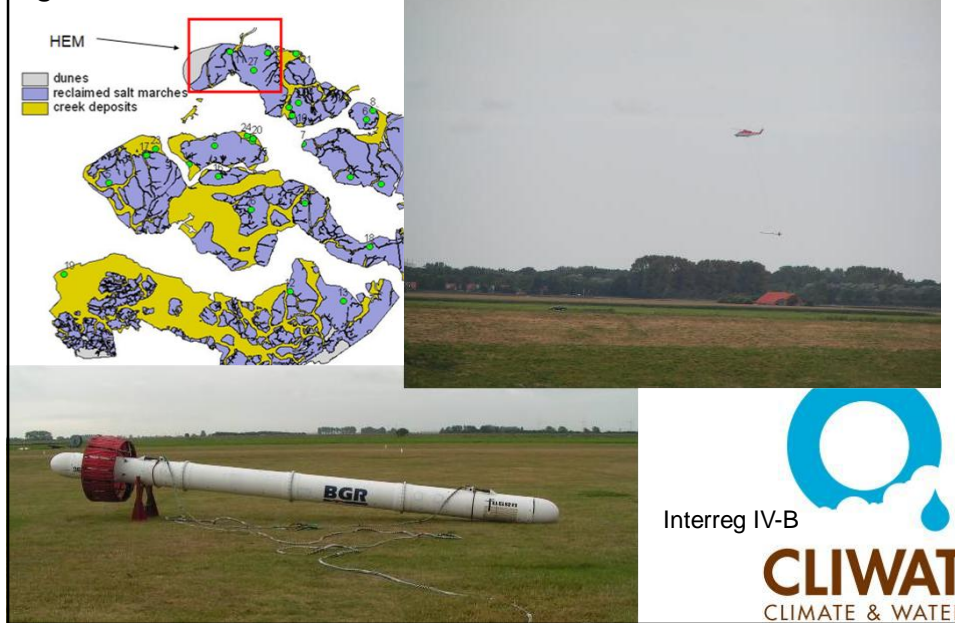

Thickness rainwater lens (D_{mix}) by HEM

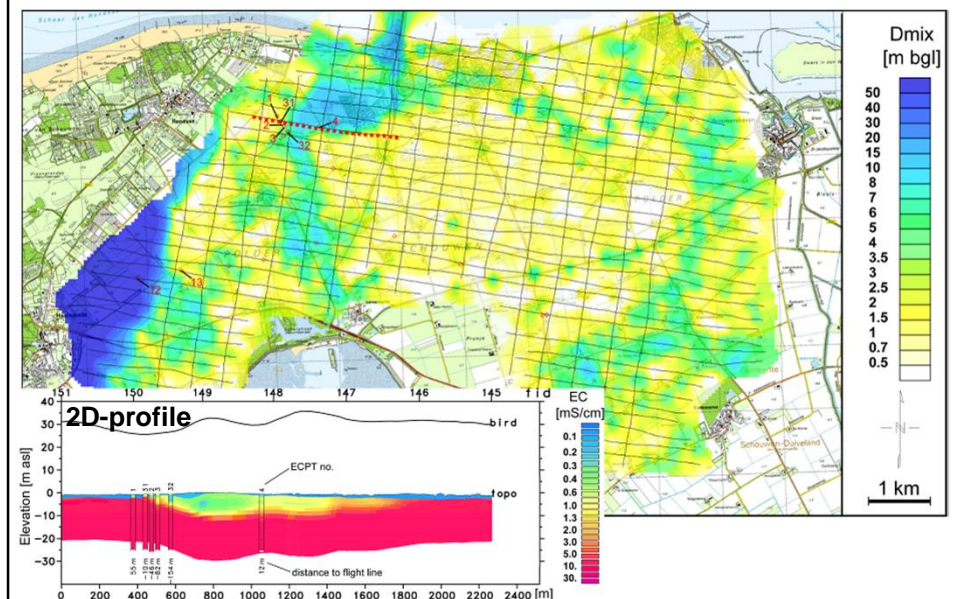

Thickness rainwater lens (D_{mix}) by HEM

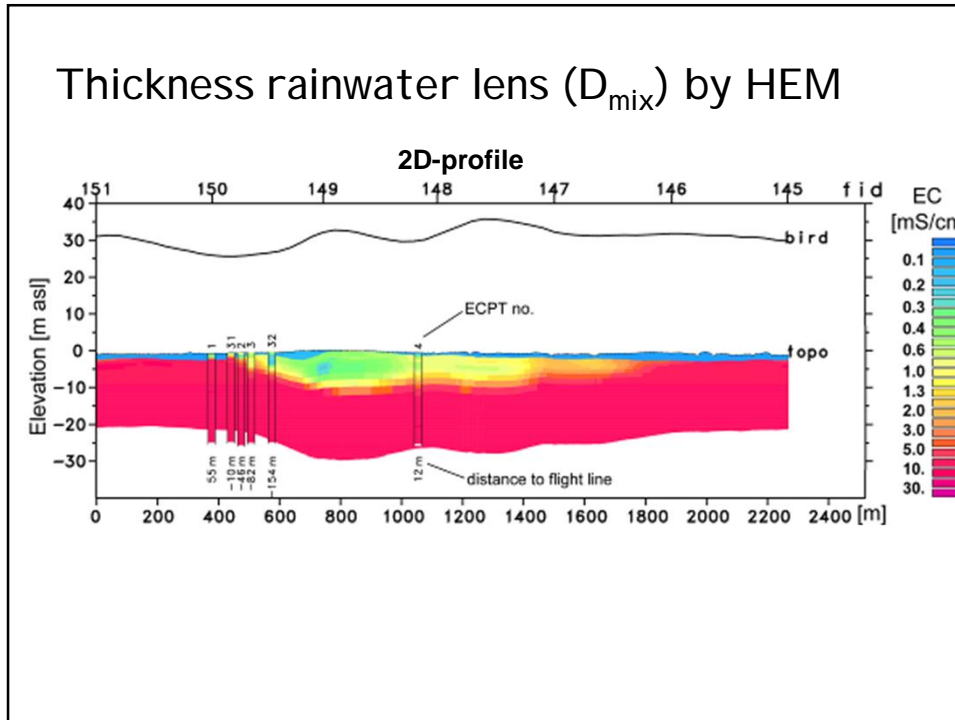

Comparison monitoring data with model results

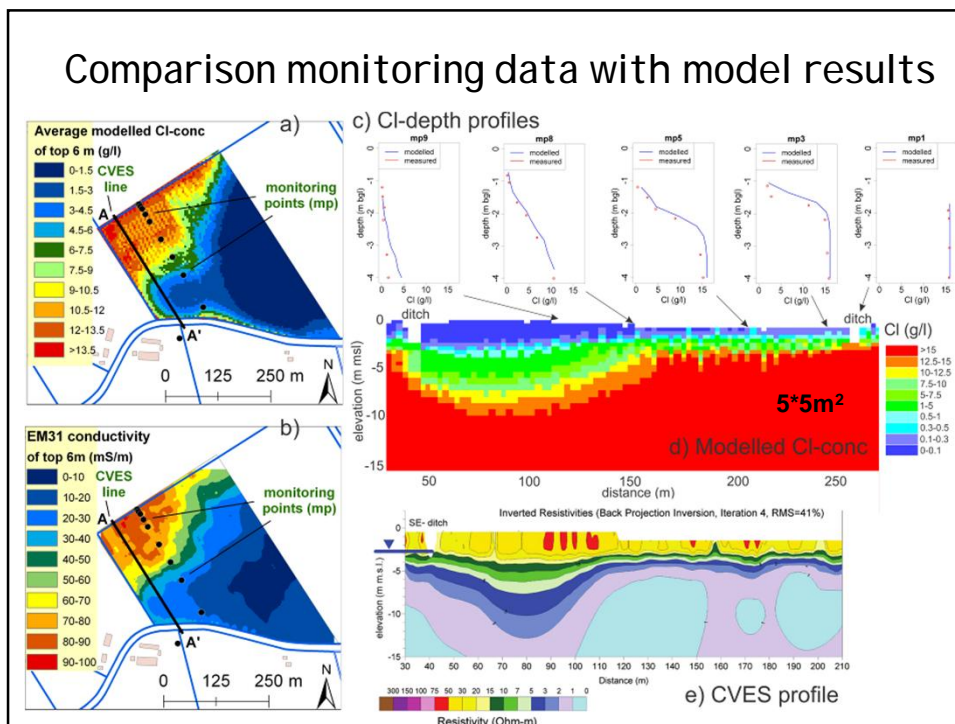

Comparison HEM - ECPT

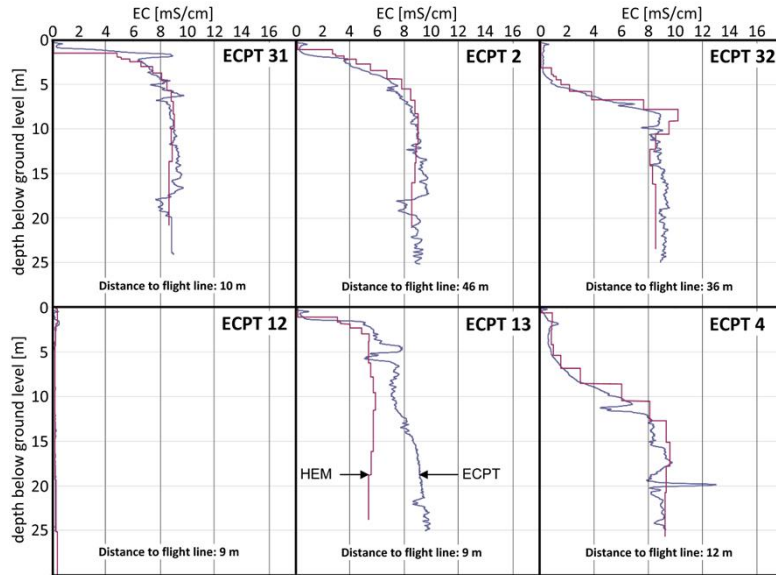

Bundesanstalt für
 Geowissenschaften
 und Rohstoffe
TRUM HANNOVER

Rainwater lens thickness (D_{mix} = average position mixing zone) mapped with HEM

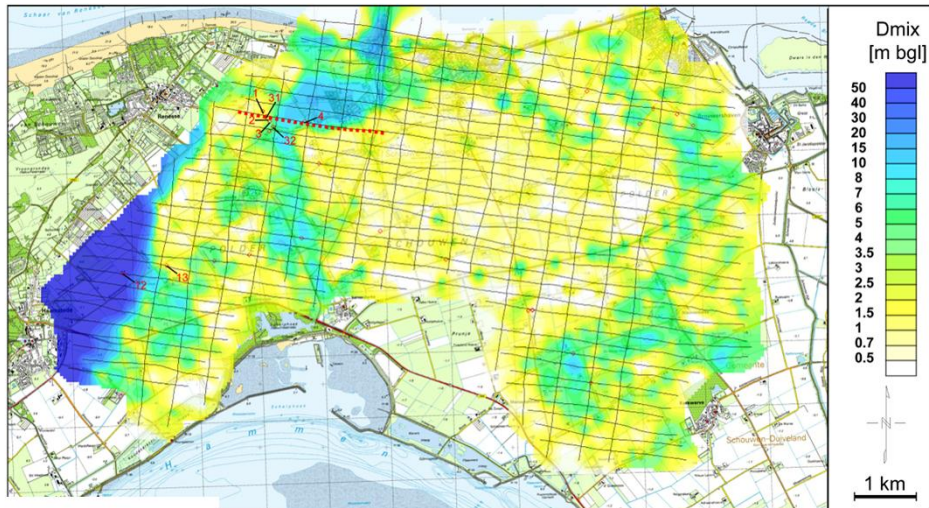

BGR Bundesanstalt für
 Geowissenschaften
 und Rohstoffe
GEOZENTRUM HANNOVER

Rainwater lens thickness (D_{mix} = average position mixing zone)
mapped with HEM

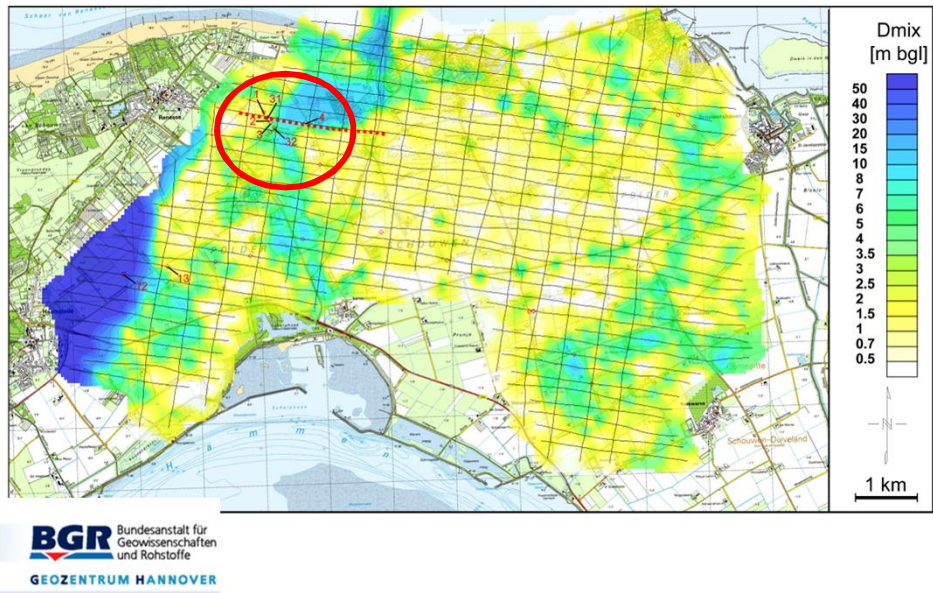

Salty boils

Louw, P.G.B., de Oude Essink, G.H.P., Stuyfzand, P.J., Zee, van der, S.E.A.T.M.,
2010, Upward groundwater flow in boils as the dominant mechanism of salinization
in deep polders, The Netherlands, J. Hydrol. 394, 494-506.

Upward groundwater seepage in a deep polder and paleochannel belts as preferential flow paths

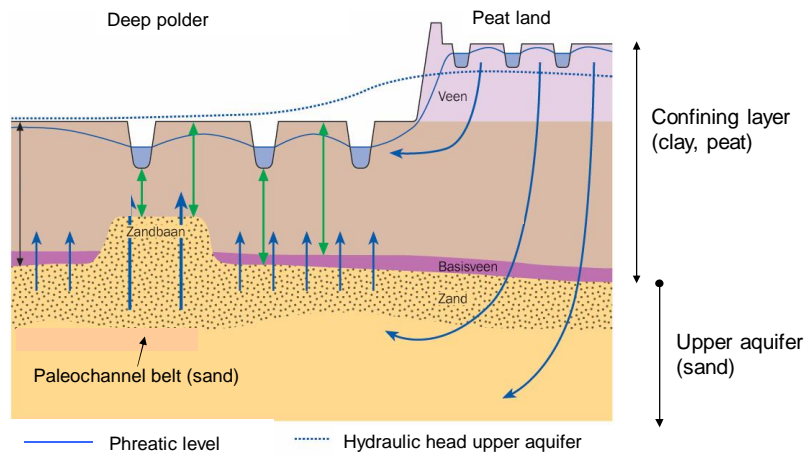

(Buried)

Paleochannel belts

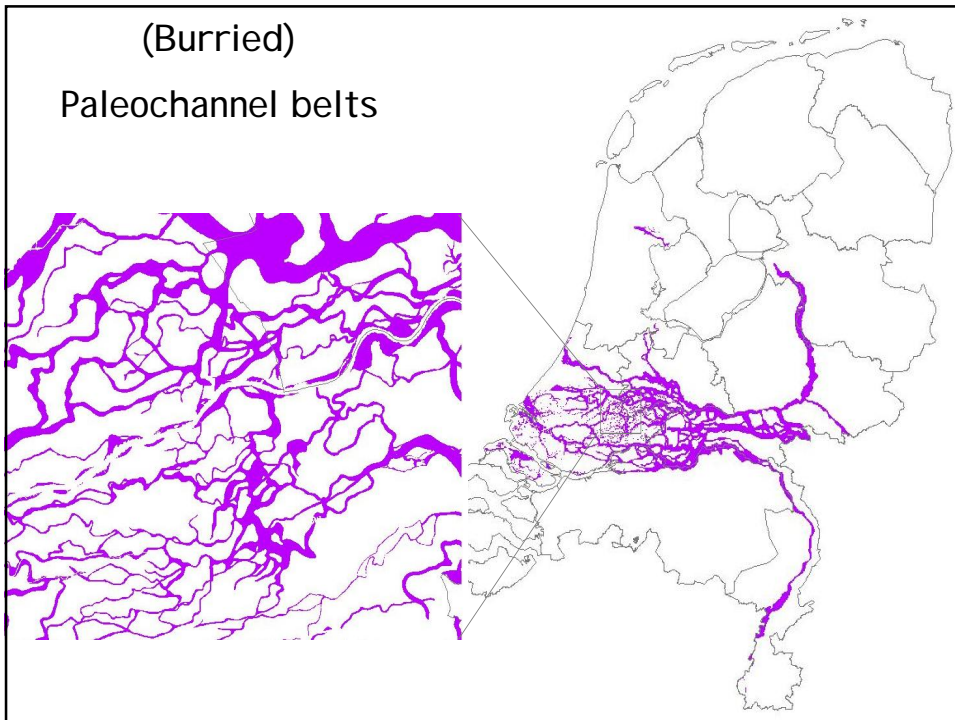

Preferential seepage via boils

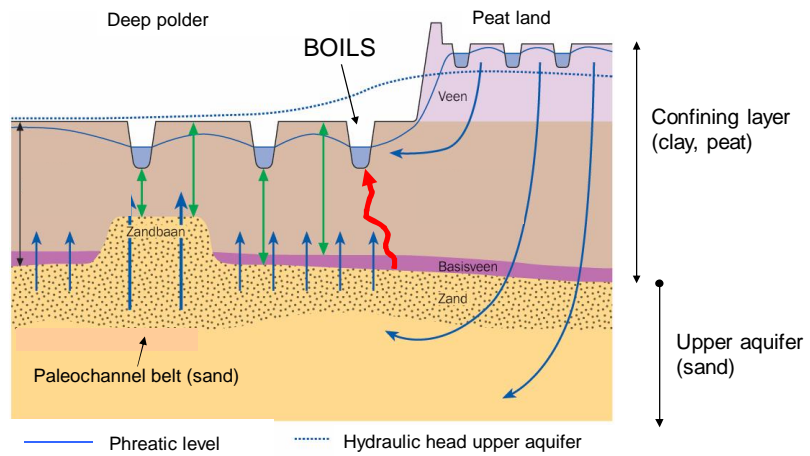

Preferential saline seepage via boils



Preferential saline seepage via boils



Three types of upward groundwater seepage

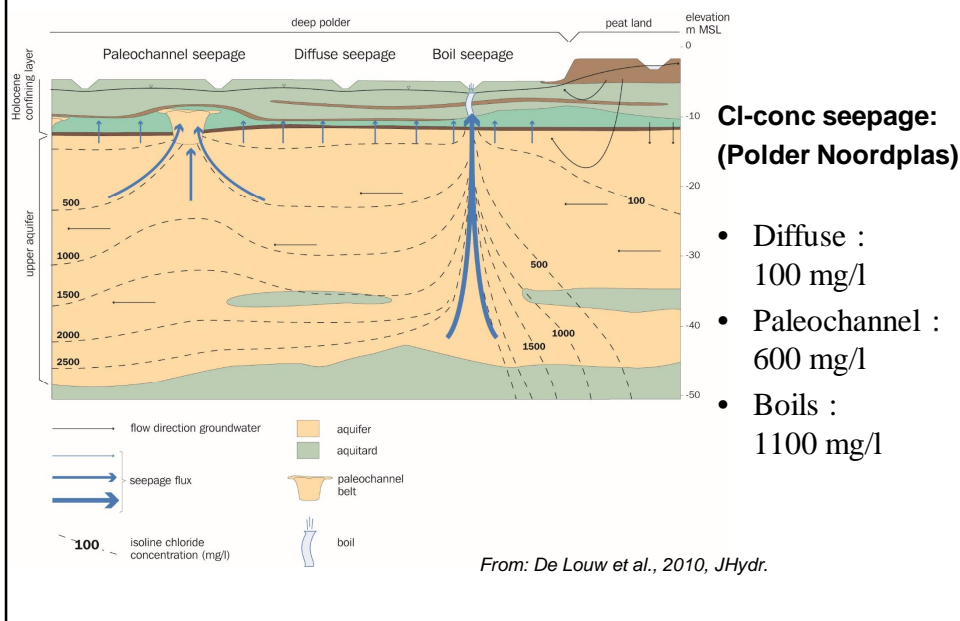



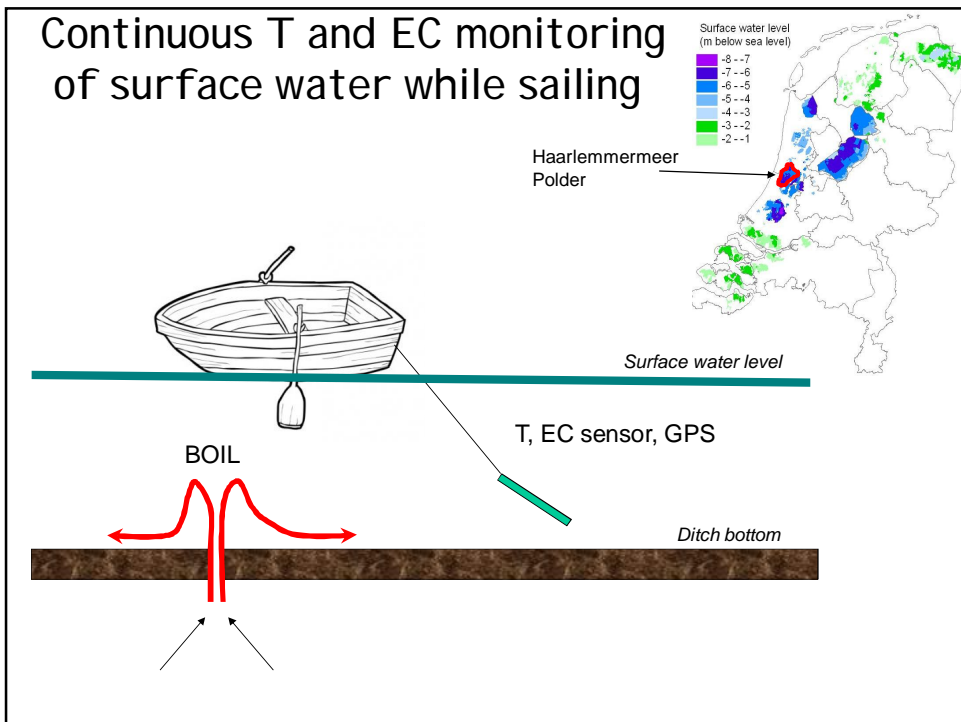

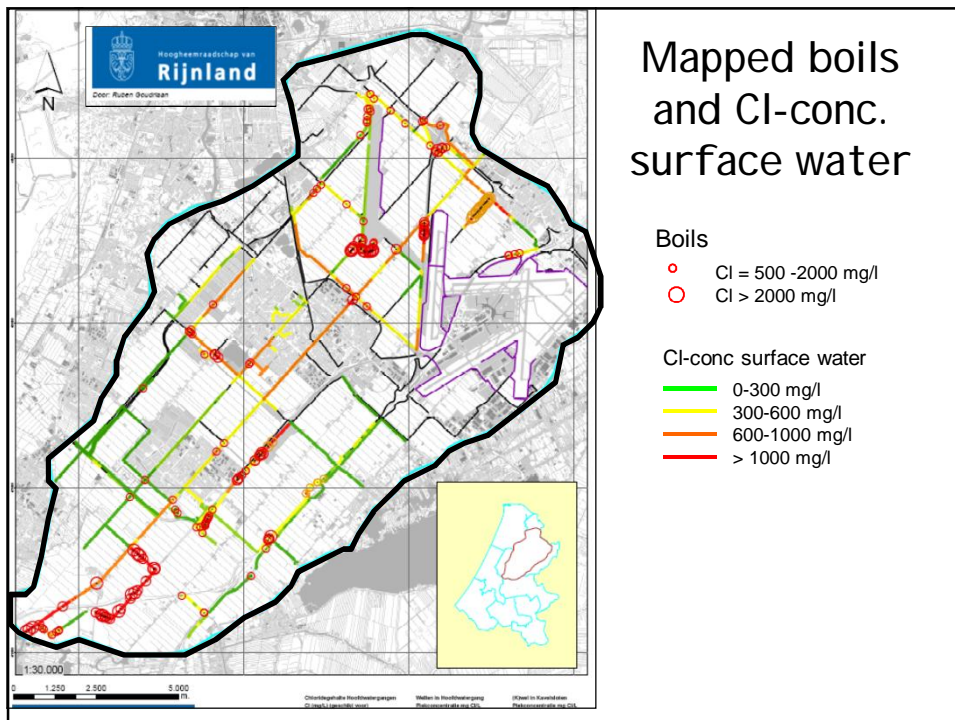
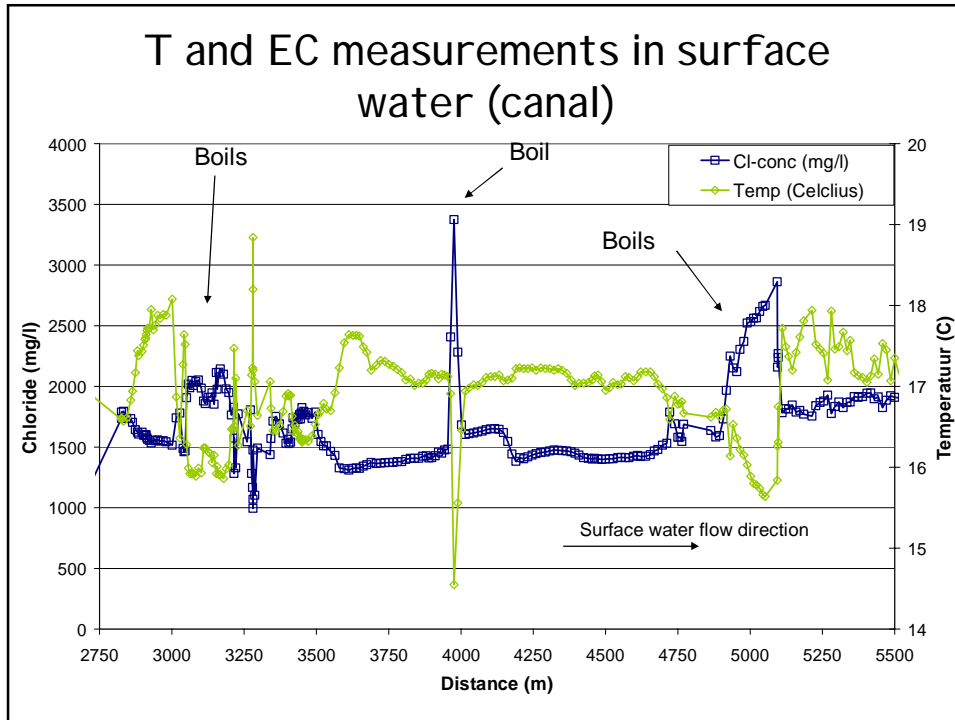

LARS technology (TNO Industry): Thermal Infra-red

- Altitude: 0-150 m
- Temp-detection using Thermal Infra Red sensors (only surface !)

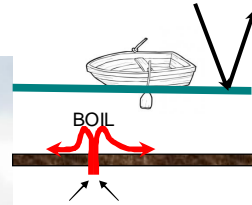

Thermal infra-red results (blue is cold, red is warm)

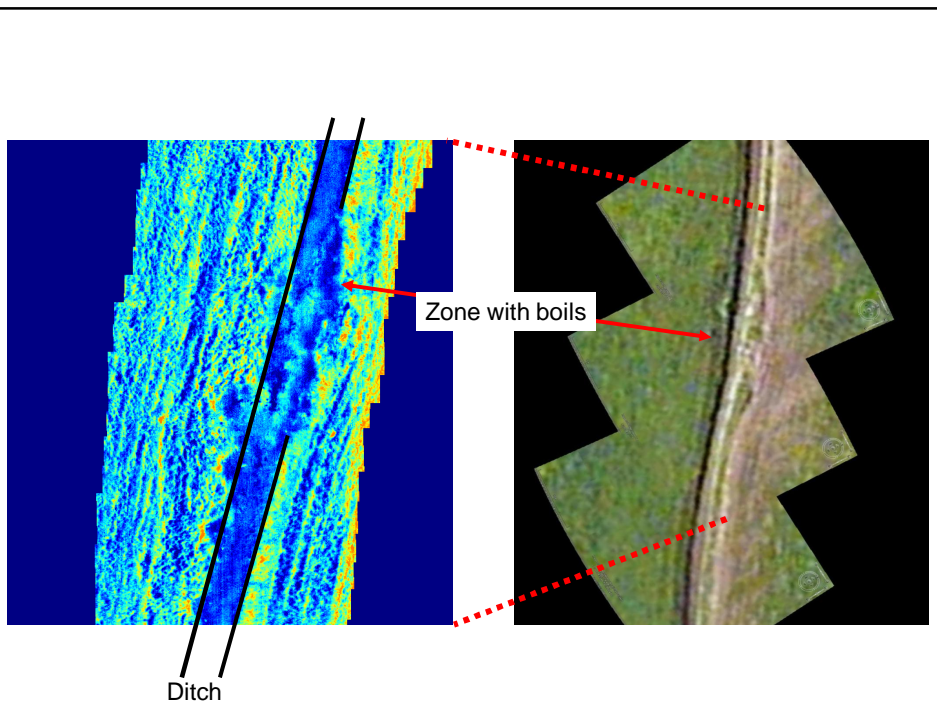
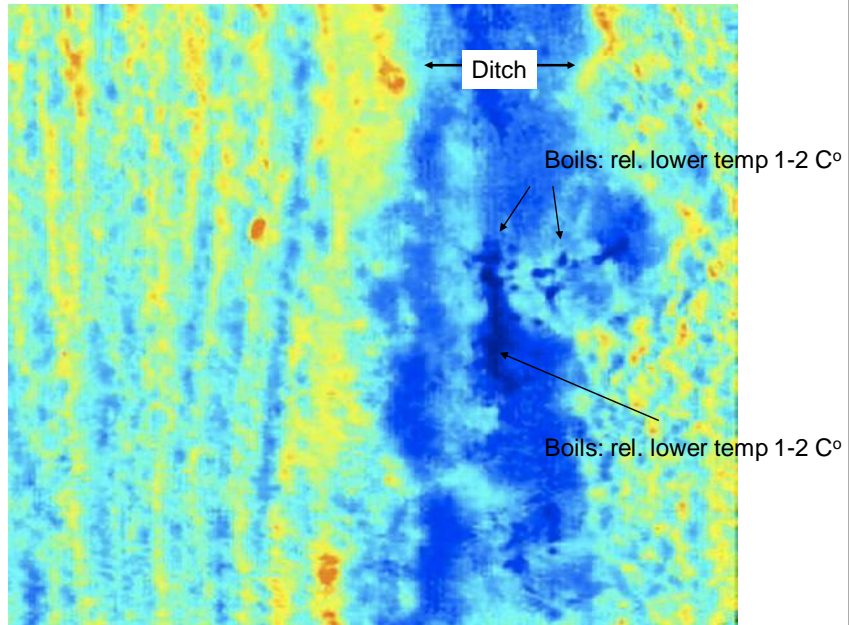

To get an idea about the possible future effects of sea level rise and climate change in your delta ...

evaluate of the past water management in the Dutch delta

Salt water intrusion in the Netherlands

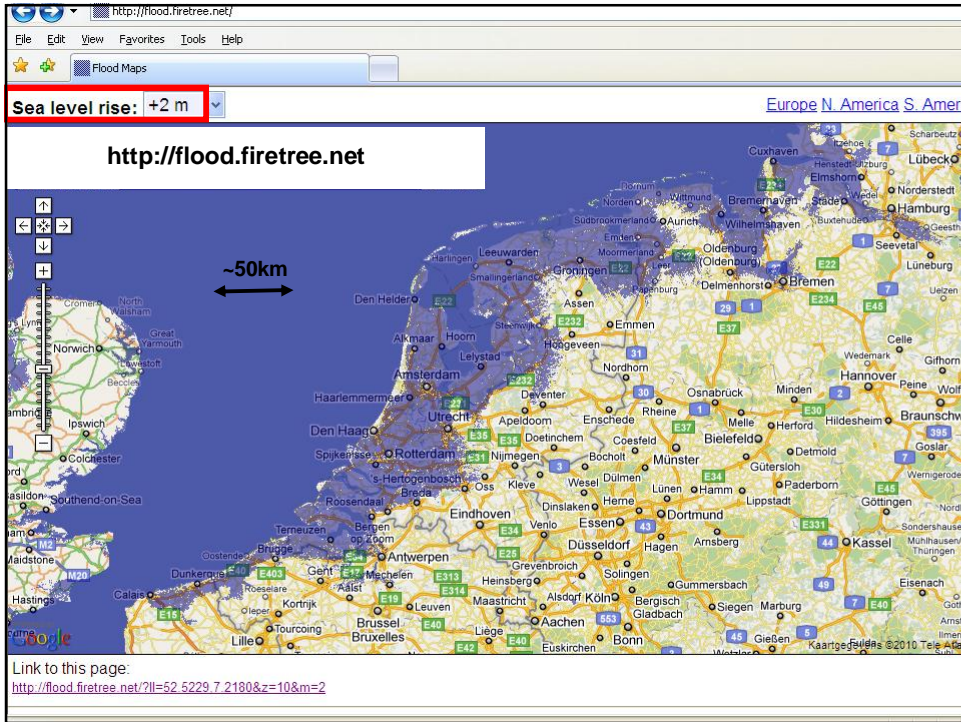

The 'low-lying' lands: Netherlands

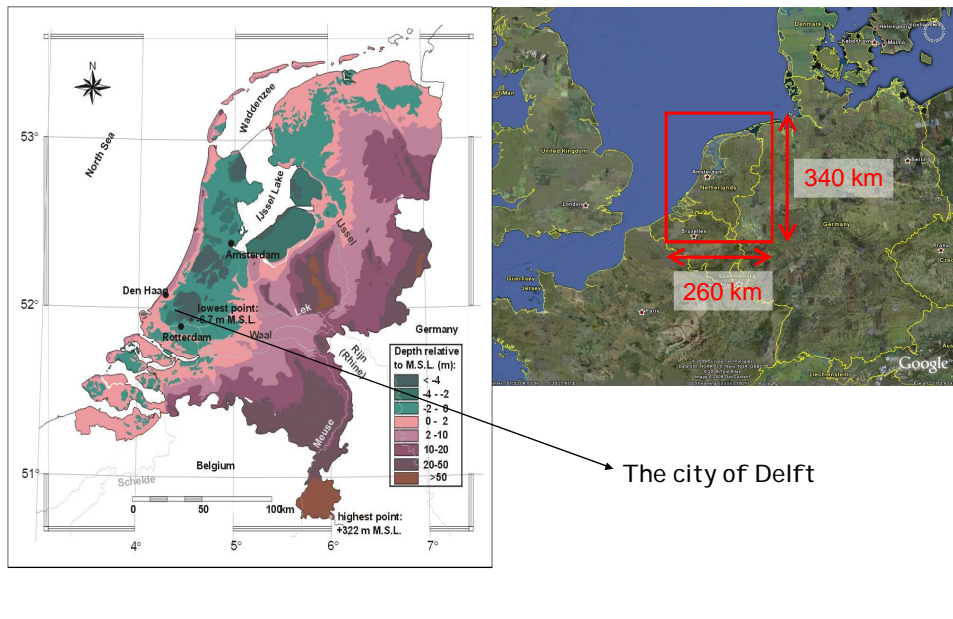

Case study: The Netherlands

The Dutch coastal zone is already theathened by sea level rise and land subsidence for many centuries

I ntensive water management system

Coping with salt water intrusion problems since 1950's



The 'low-lying' lands: Netherlands

The facts:

- a deltaic area with 3 rivers: Meuse, Scheldt & Rhine
- 25% of land surface is lying below mean sea level
- 65 % would be flooded regularly if there were no dunes and dikes
- 8 million people would be endangered



The Great Flooding in february 1953

Combination of high tide and heavy storm:

- 1853 casualties
- 2000 km² flooded



Infrastructure to protect our low-lying land from flooding

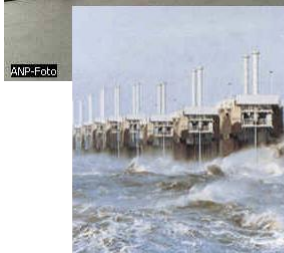

River flooding in 1995

Combination of heavy rains upstream the catchment
& short retention time



Dike collapse 2003

Combination of peat dike instability and very dry summer



Estimated water management costs 'to keep our feet dry'

Costs up till 2050 in billion euros:

ivers: upper part	5.7
ivers: lower part	5.6
low-lands	1.7
coastal zone	8.0
infrastructure	3.5
purchase of ground	2.0
	-----+
	26.5 billion euros

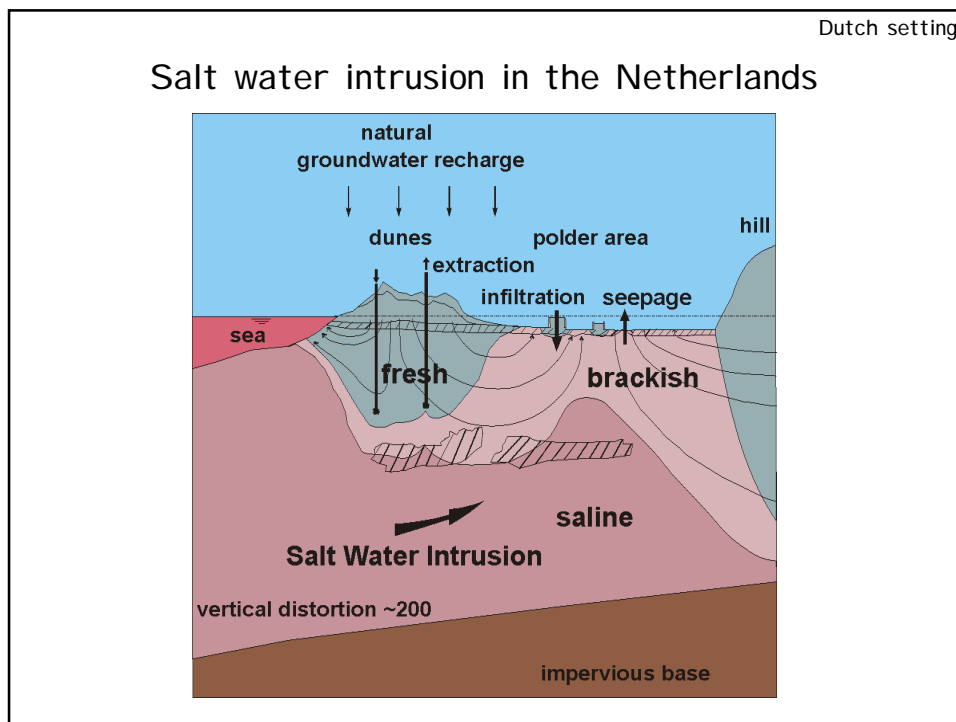

Present ground surface in the Netherlands

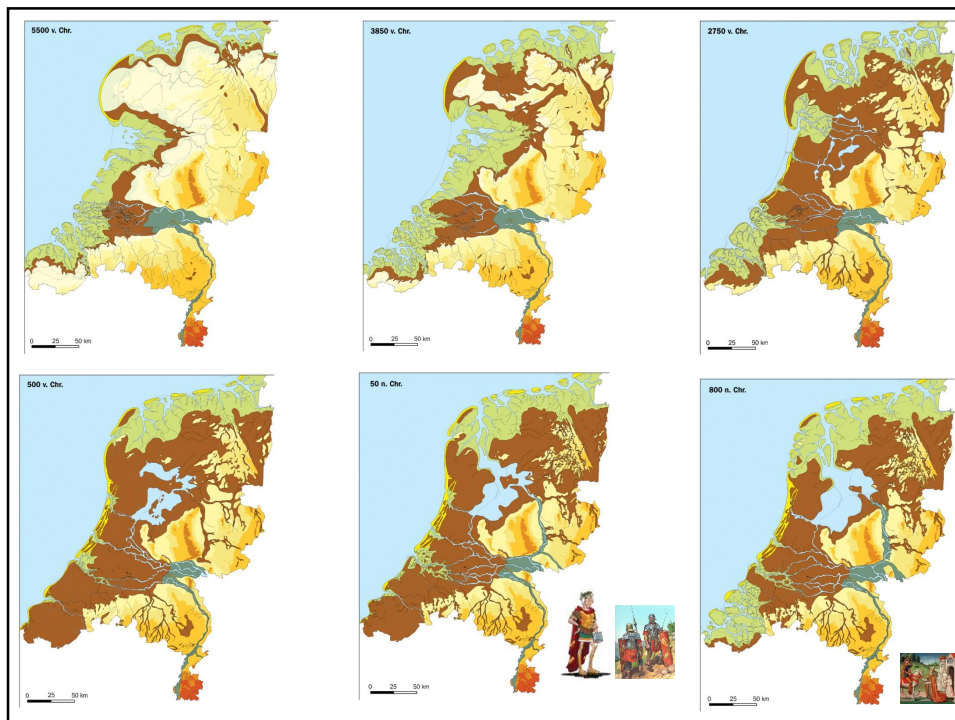
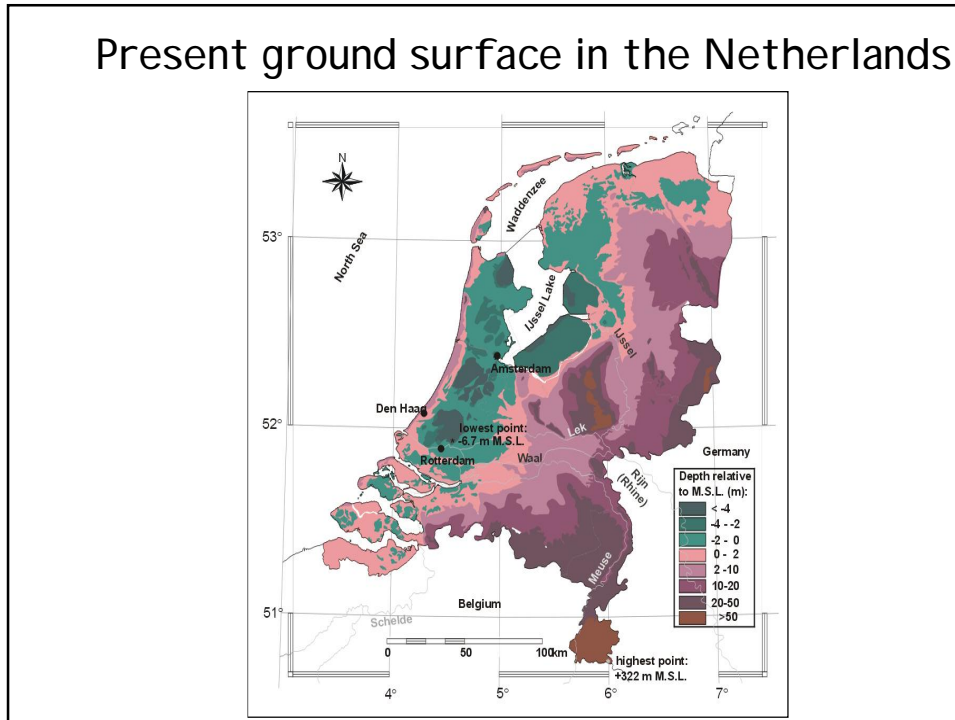

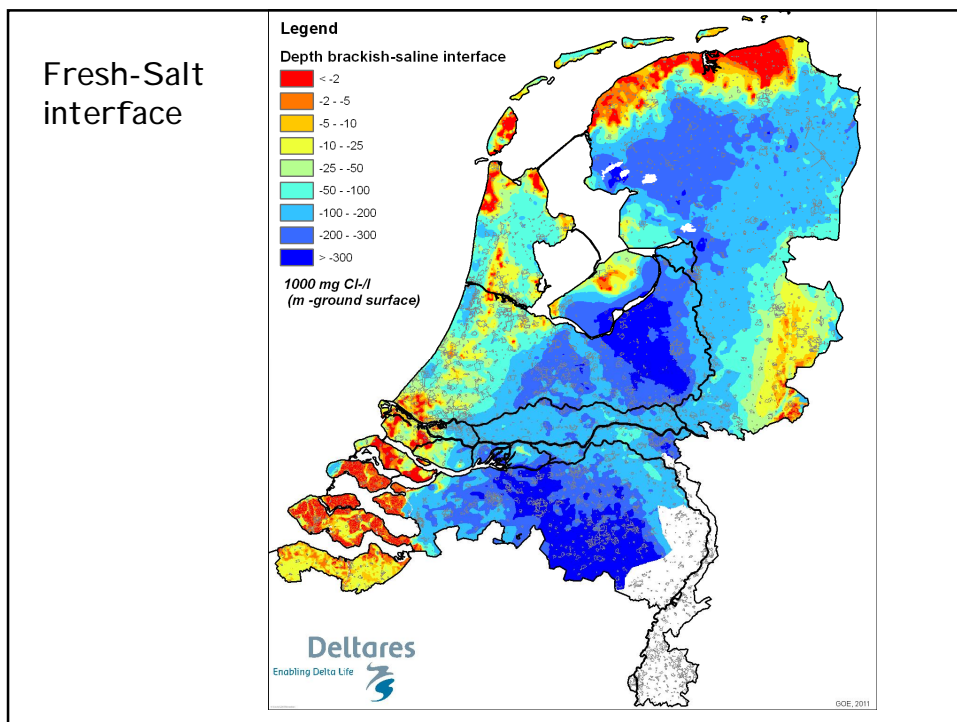
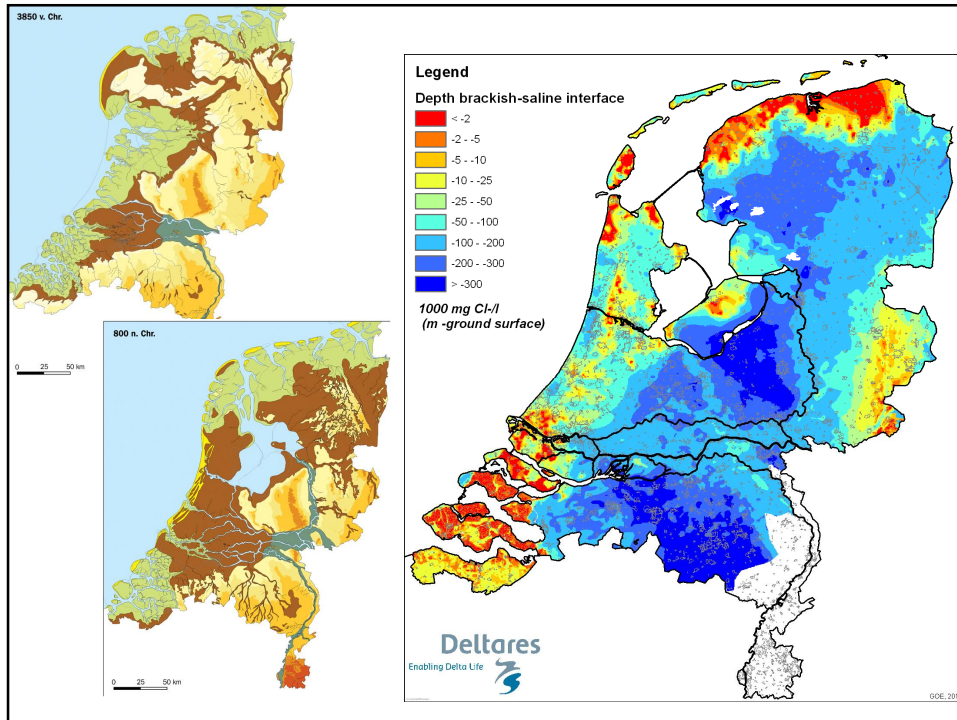

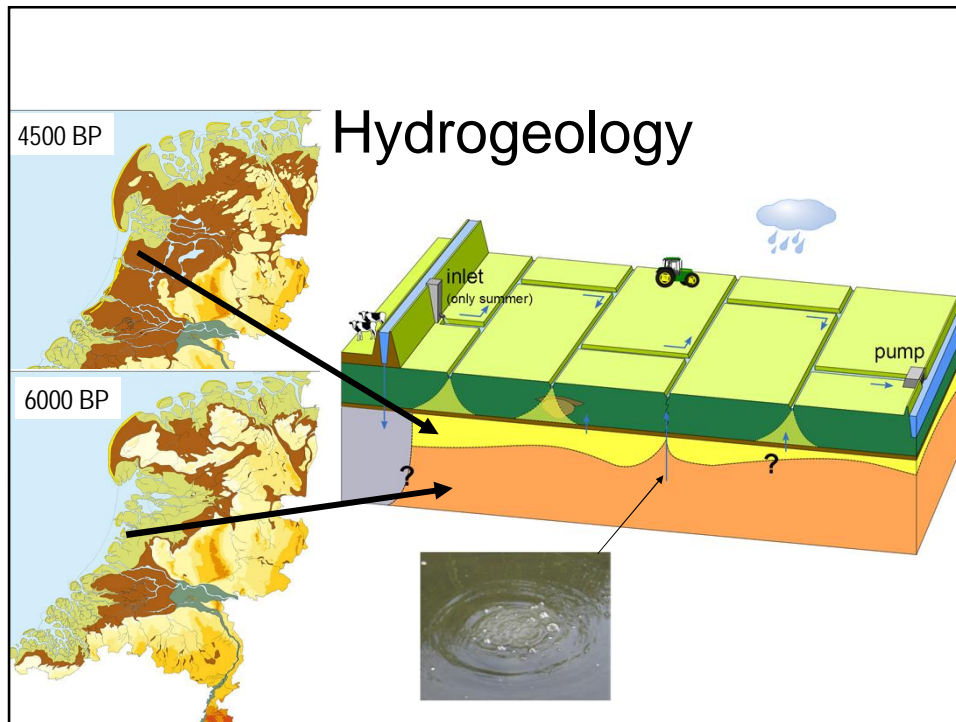

Dutch setting

Salinisation of the Dutch subsurface

Physical transport processes:

- advective: e.g. trans- and regressions
- dispersive: mixing with marine deposits
- diffusive: e.g. I Jsselmeer lake
- chemical: solution, precipitation, ion-exchange

Anthropogenic causes:

- land subsidence
- polder level lowering
- groundwater extractions

Future developments (climate change):

- sea level rise
- changes in recharge

Dutch setting

Abrupt land subsidence

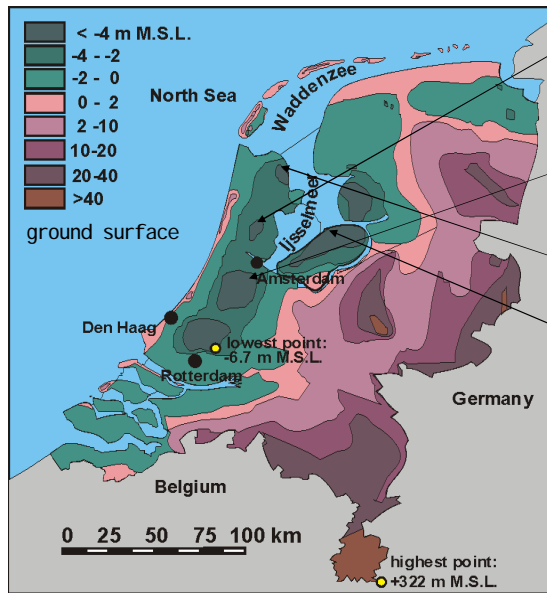

position polders:

- Beemster 1608-1612
- Wormer 1625-1626
- Schermer 1633-1635
- Purmer 1618-1622
- Haarlemmermeer polder 1850-1852
- Wieringermeer polder ~1930
- Flevo polders 1950-60s

Land reclamation since 1300

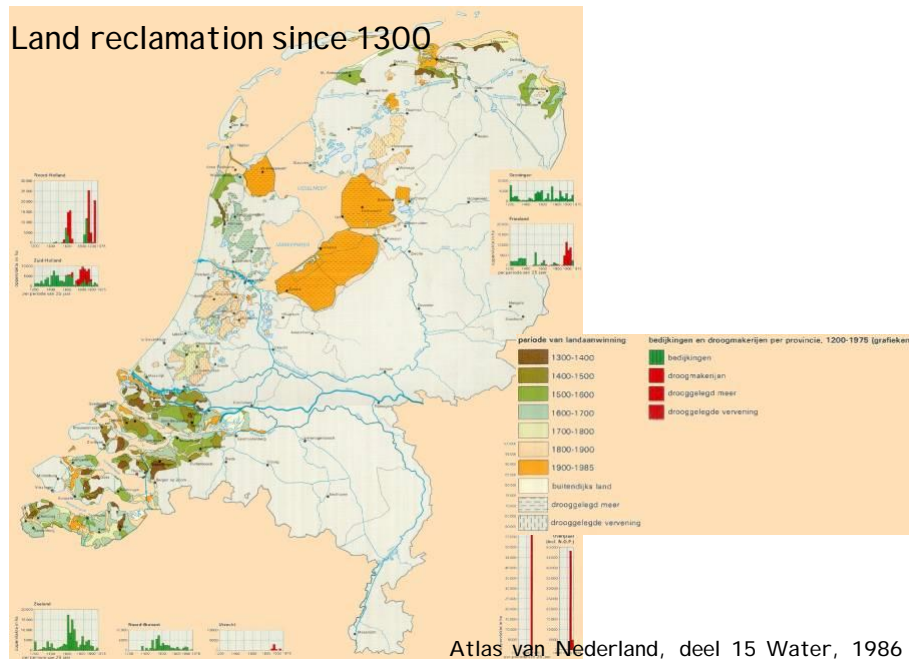

Development of the Dutch 'Polder' Landscape

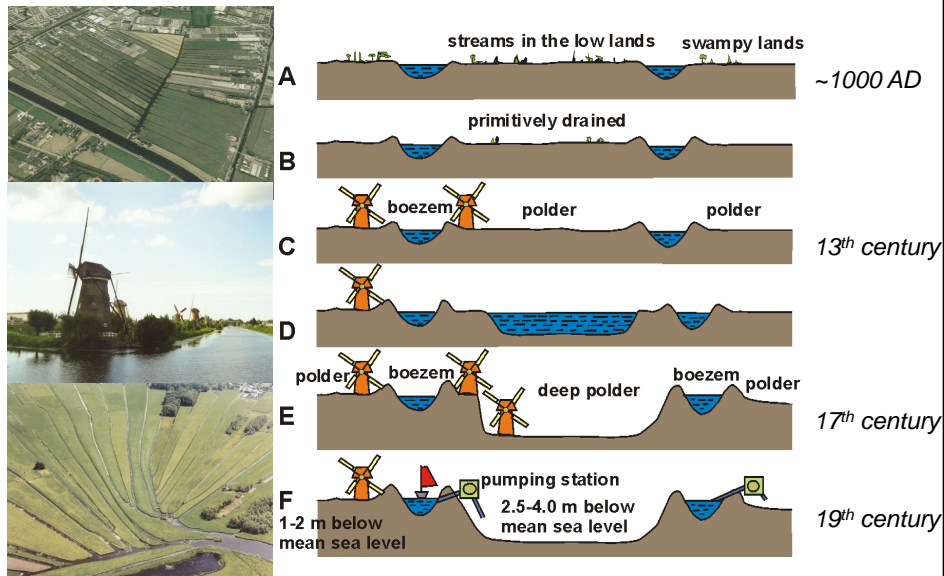

From fresh water outflow to salt water inflow

Causes:

- Autonomous processes
- Land subsidence
- Abrupt land reclamation
- Climate change
- Sea level rise
- Change in net recharge

Historical subsidence of the ground surface in Holland

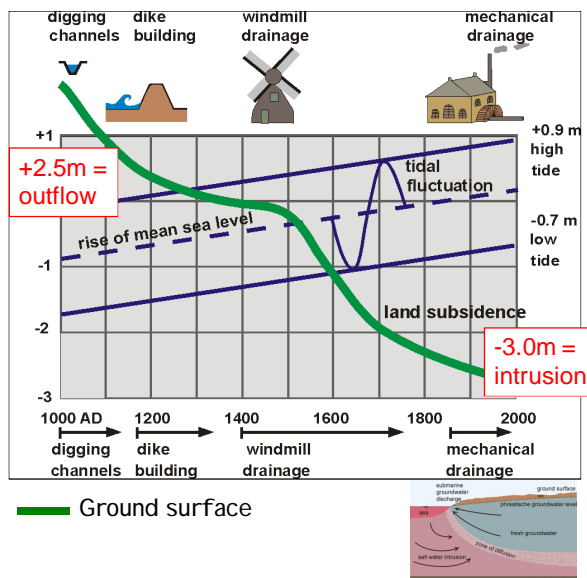

Land subsidence related to M.S.L.

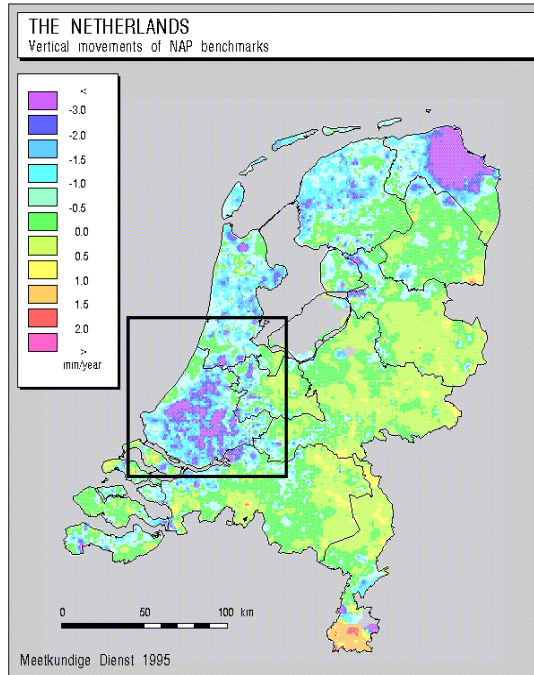

Land subsidence



up to 1 m per century



The polder system

A land below the sea with an excess of water needs..
a sophisticated drainage system

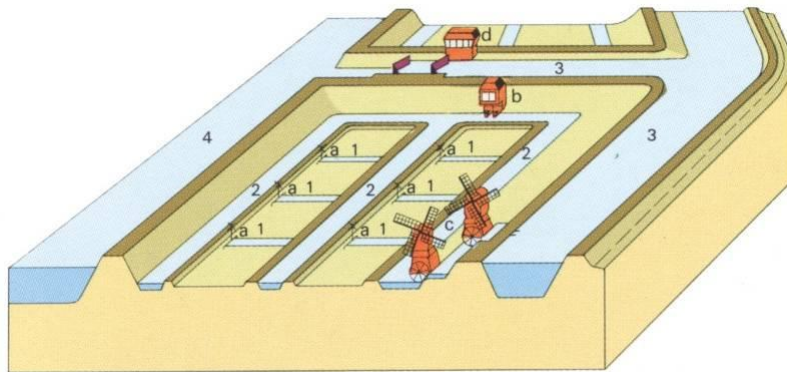

The polder system

*Many agricultural plots with
different water levels
throughout the season*



The polder system



The polder system



Bulb farms at the landside of the sand dunes



Salt damage in 1976 (very dry year)

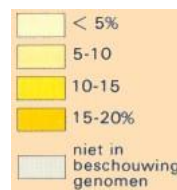

Salt damage [percentage] in potential crop-production

Atlas van Nederland, deel 15 Water, 1986

Drought damage in 1976 (very dry year)

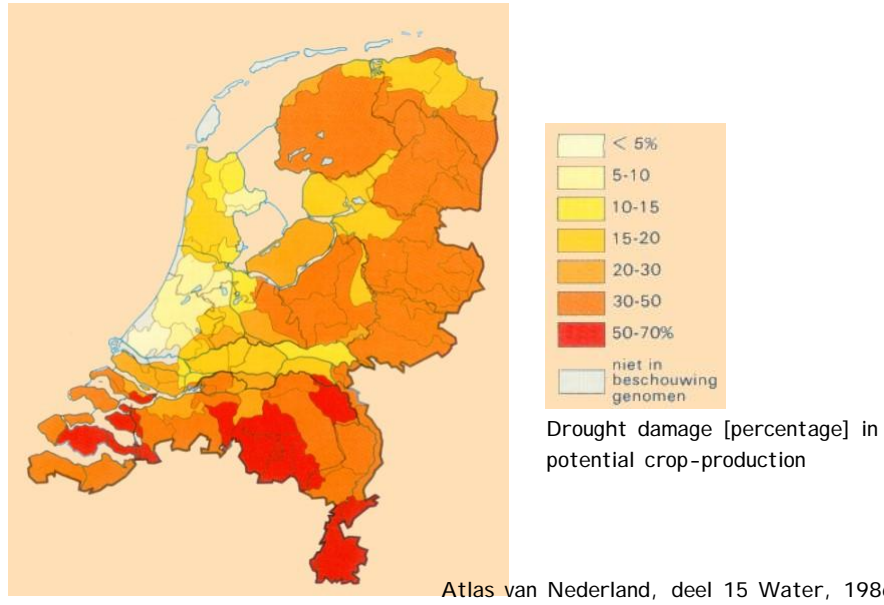

Impacts

'Wetting' damage



Normal situation

Crop damage due to a reduction in groundwater extraction in the dune area



Now focus on groundwater...

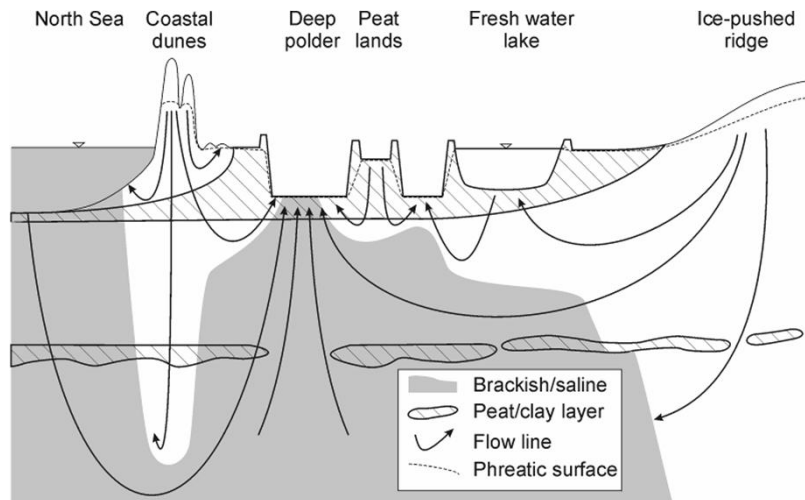

Threats to water management due to climate change:

Short term threats:

- flooding
- dike collapse
- drought

asks for operational water management

Long term threats:

- salt water intrusion
- land subsidence
- smaller fresh groundwater resources

asks for strategic water management

Past and future sea level rise in the Netherlands

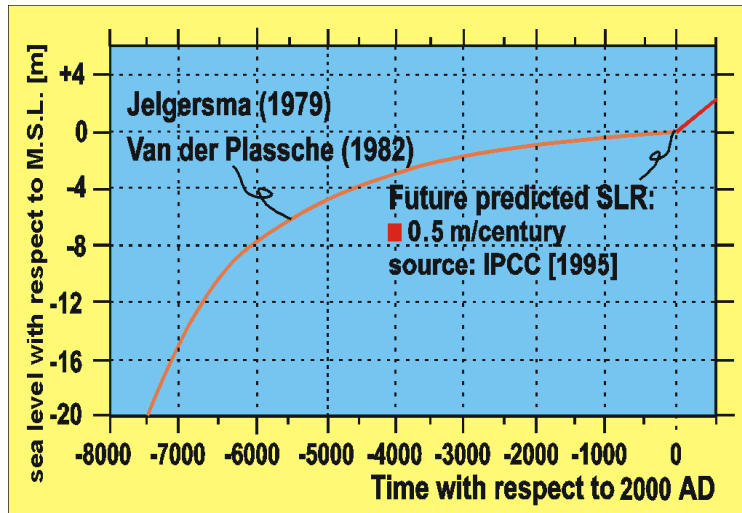

Numerical variable density models at Deltares

Characteristics:

- variable-density groundwater
- fresh, brackish and saline
- 3D, non-steady
- coupled solute transport

Code (MODFLOW family):

MOCDENS3D
SEAWAT

Assessing effects:

- autonomous salinisation
- sea level rise
- changing recharge pattern
- land subsidence
- changing extraction rates
- adaption measures

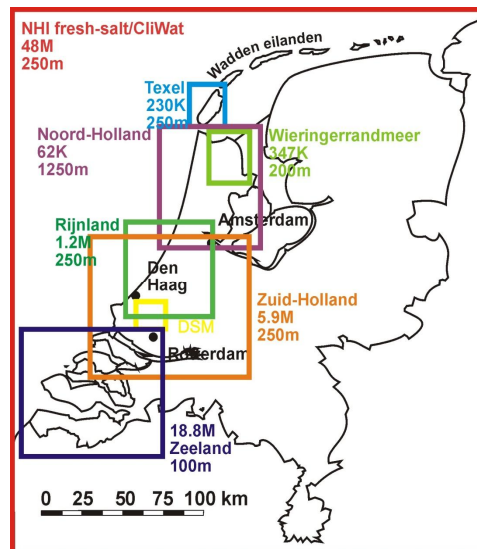

'DO NOT DO THIS AT HOME!' (DATA PROBLEM)

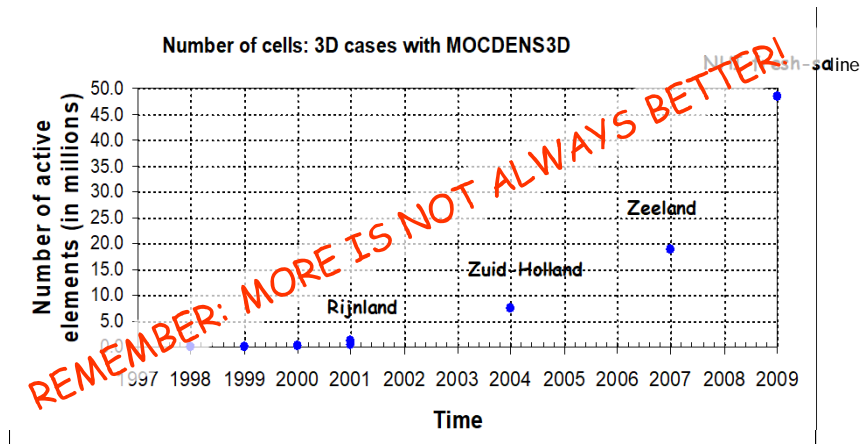

Modelling effect sea level rise on salt water intrusion

2D models

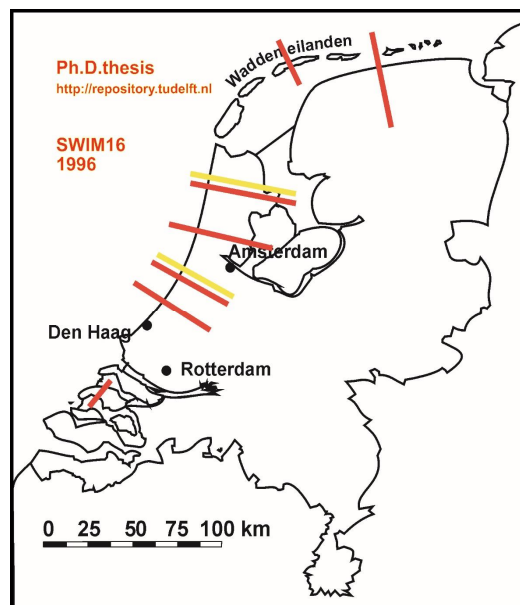

Modelling effect sea level rise on salt water intrusion

3D models

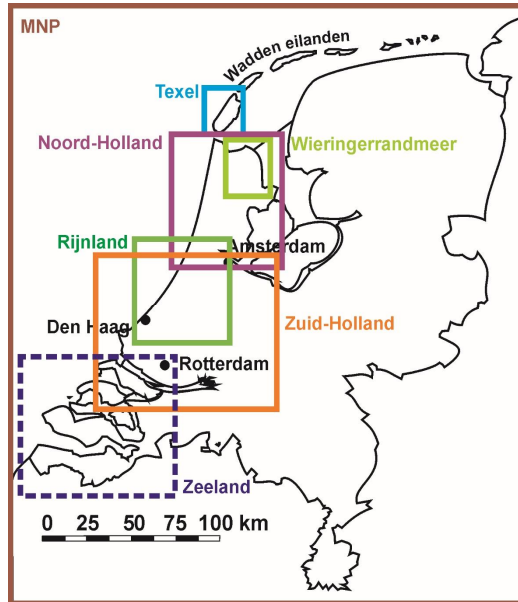

Modelling effect sea level rise on salt water intrusion

3D models SWIM

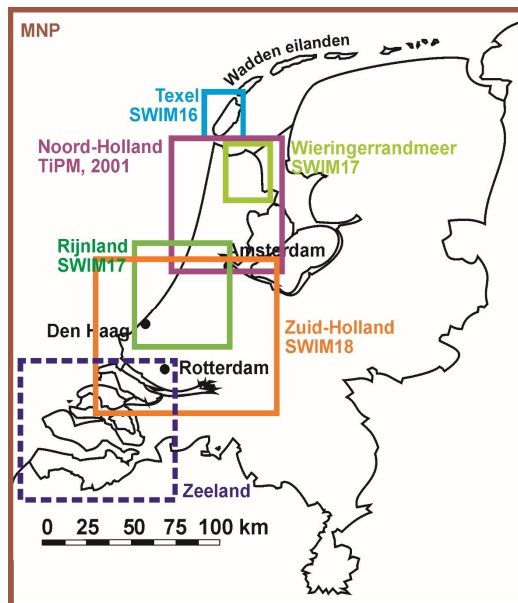

Modelling effect sea level rise on salt water intrusion

**3D models
number cells**

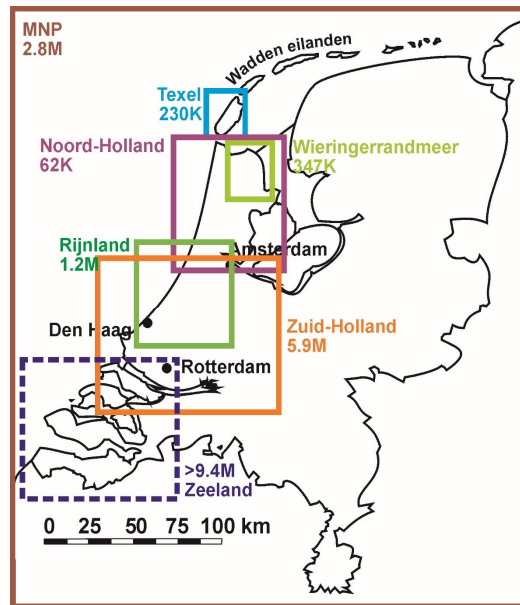

Recent model study for the whole Netherlands on the effect of sea level rise of water management (1)

Using the national subsoil parametrisation

- REGIS V2
- Top geological system from +10m up to -280m M.S.L.
- 31 model layers with thicknesses: 2*5m; 10*2m; 8*5m en 11*20m
- cellsize 1000x1000m (coarse)

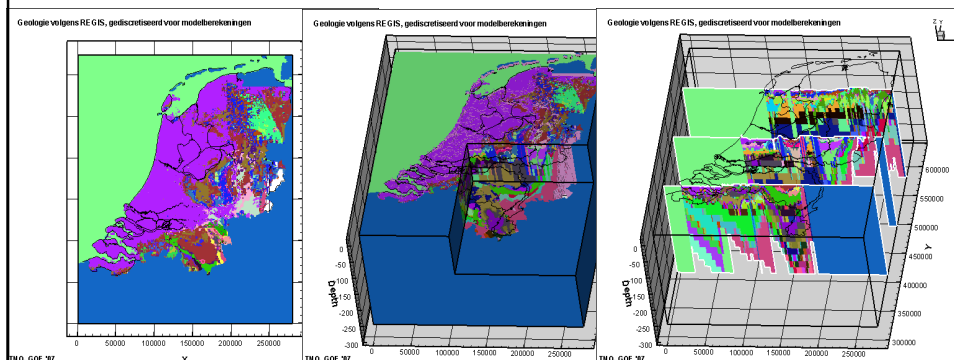

Recent model study for the whole Netherlands on the effect of sea level rise of water management (2)

Using the national 3D salt concentration in groundwater
 Fresh-Salt REGIS: ~65000 measuring points (analyses, VES, Borehole)

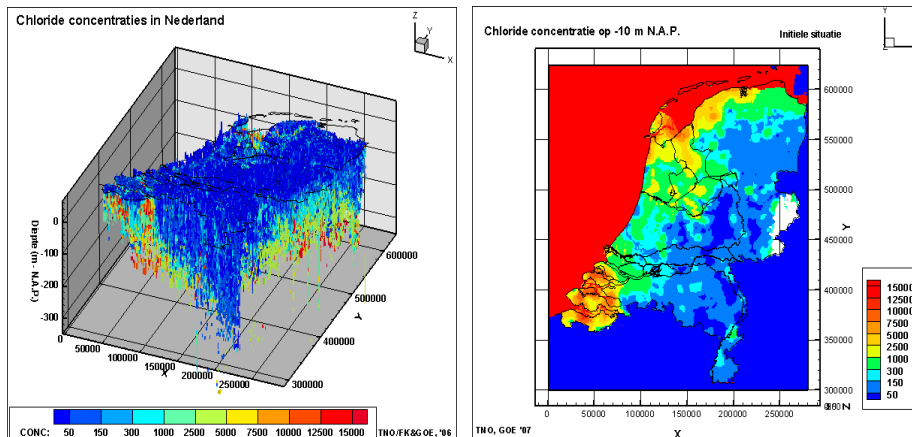

Recent model study for the whole Netherlands on the effect of sea level rise of water management (3)

- Variable-density 3D groundwater flow model and coupled solute transport
 - 10 scenario's, including extreme sea level rise
 - including land subsidence estimates

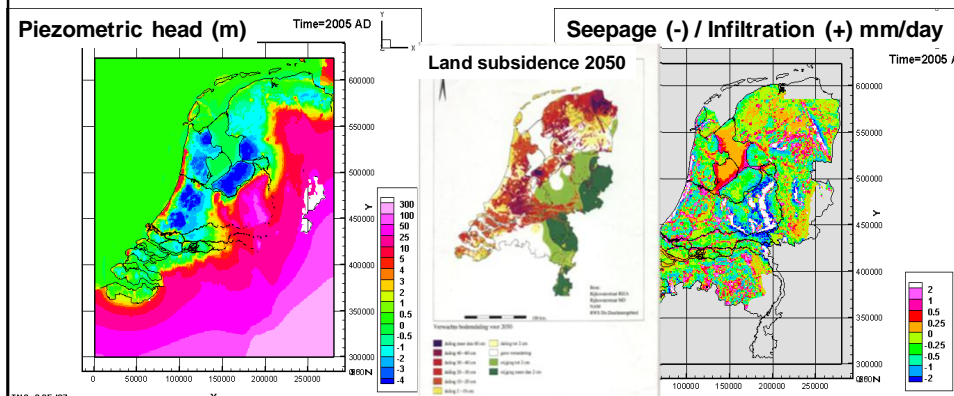

Results: zone of influence 1m sea level rise

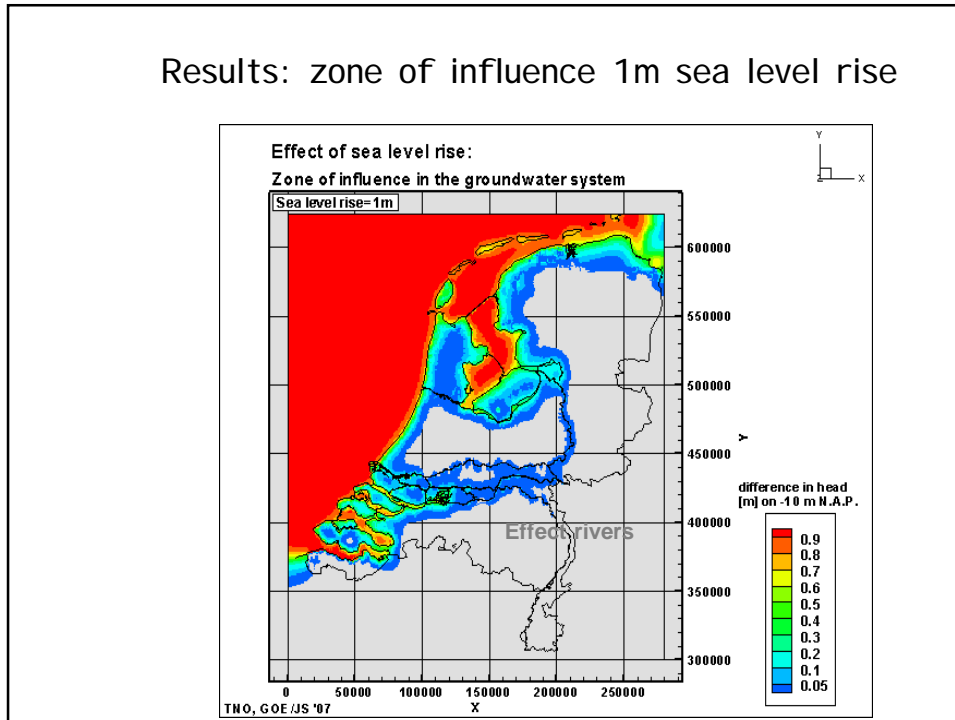

Salinisation over the period 2000-2050

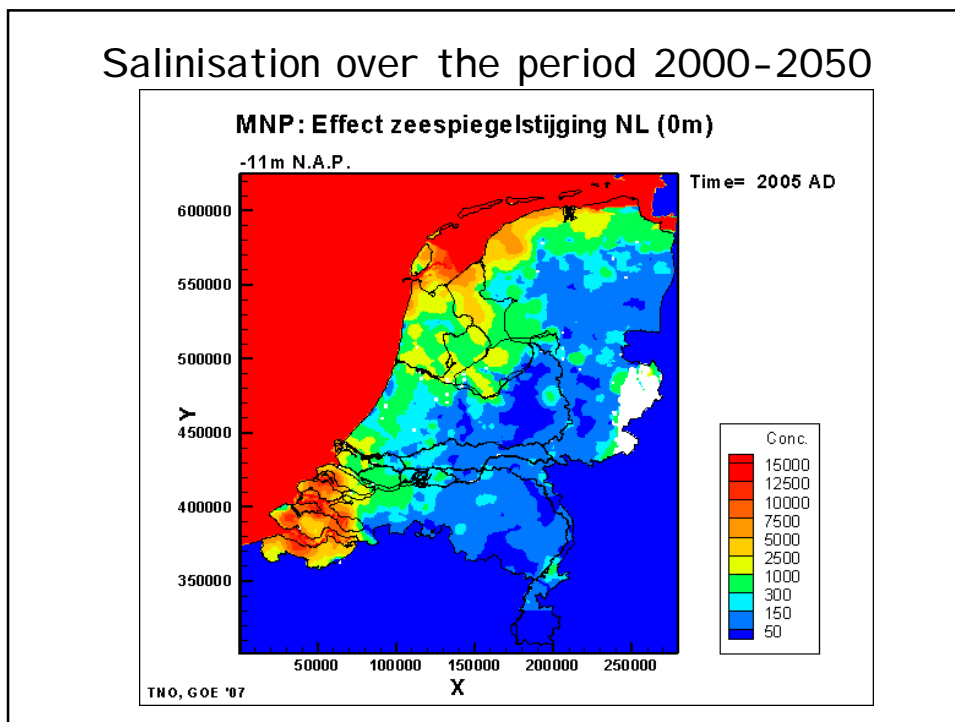

Salinisation subsoil at 0m sea level rise in 2050

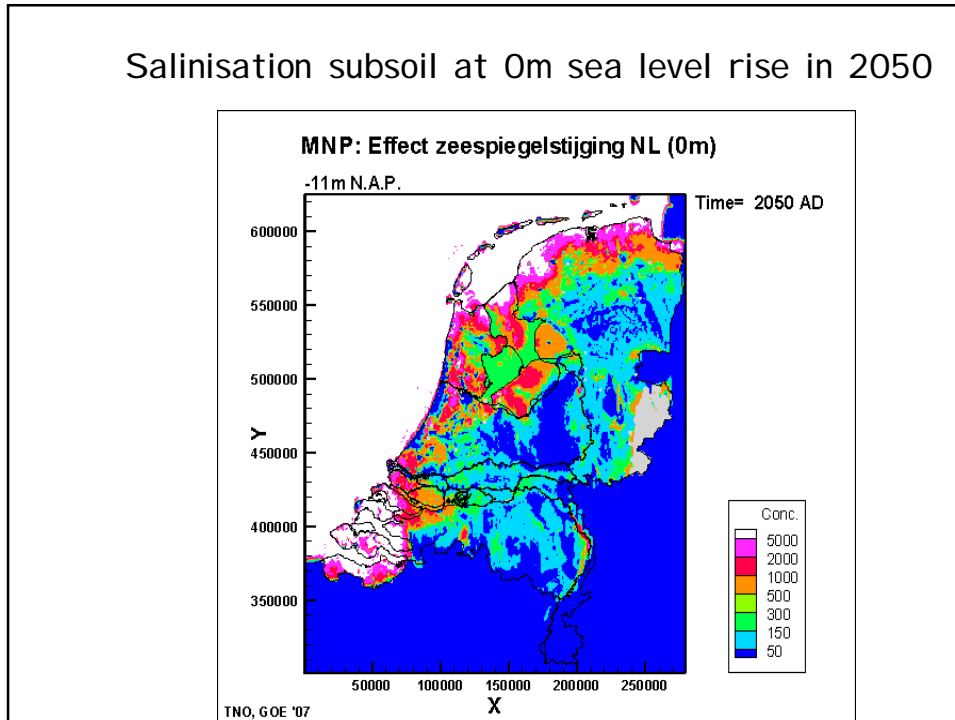

Salinisation subsoil at 2m sea level rise in 2050

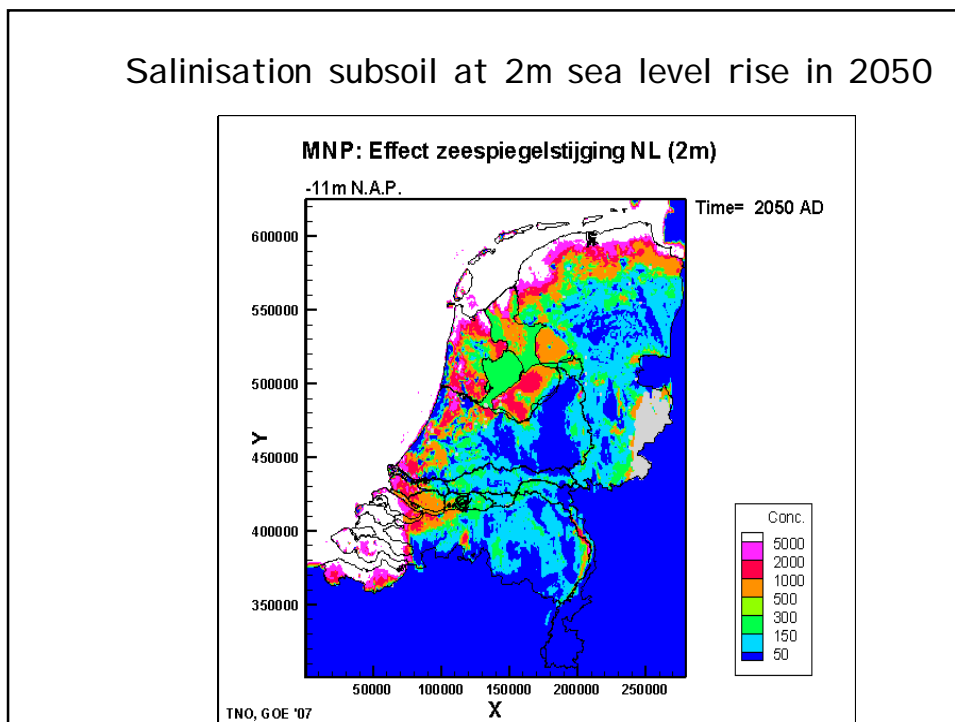

Salinisation subsoil at 4m sea level rise in 2050

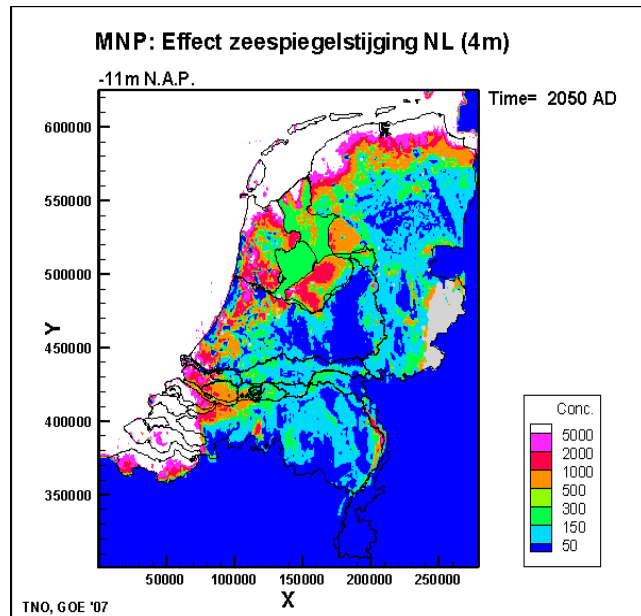

Salty wells

Seepage and infiltration situation around deep polders

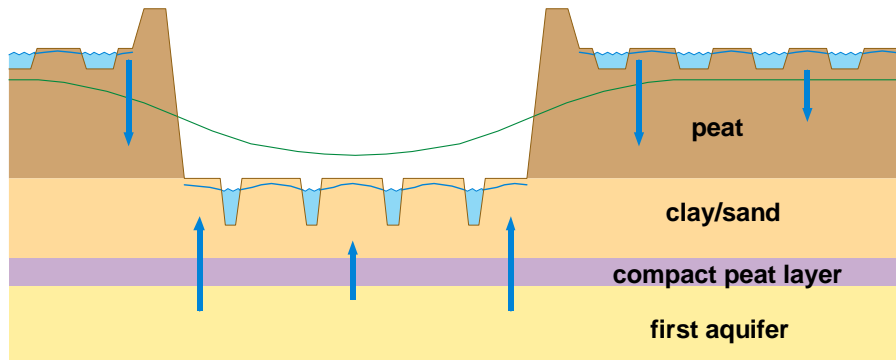

Risk of instable Holocene aquitards (1)

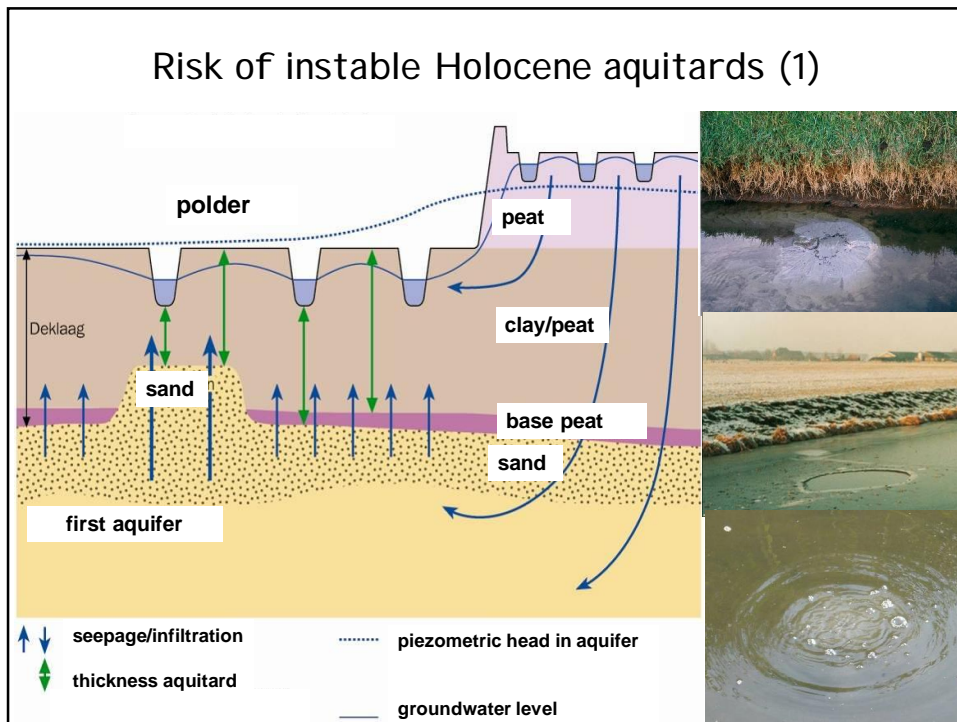

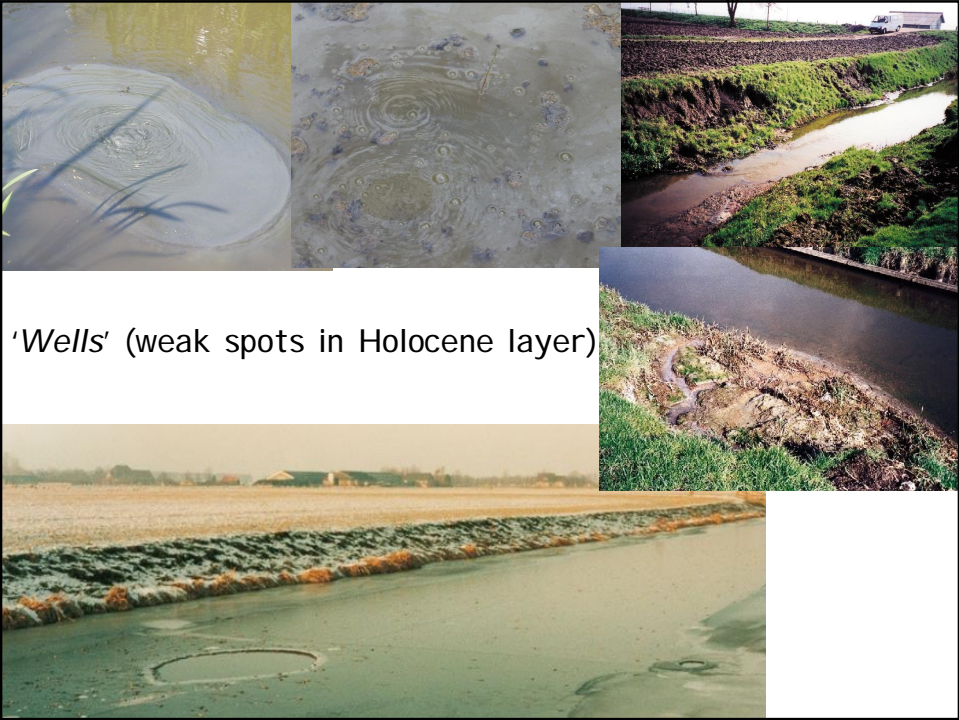
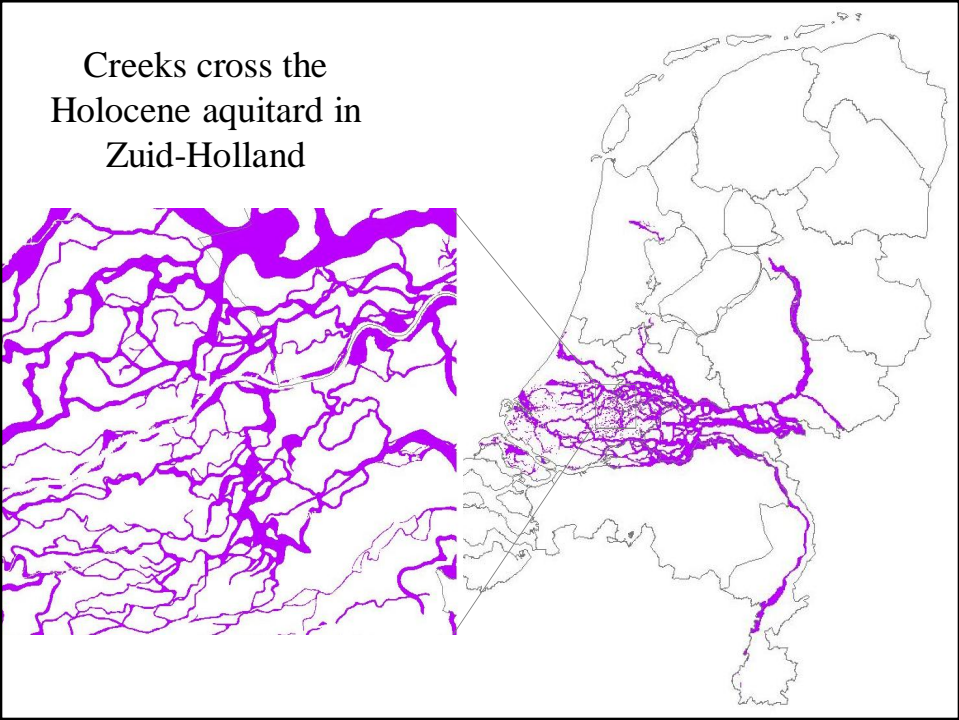

Temperature measurements

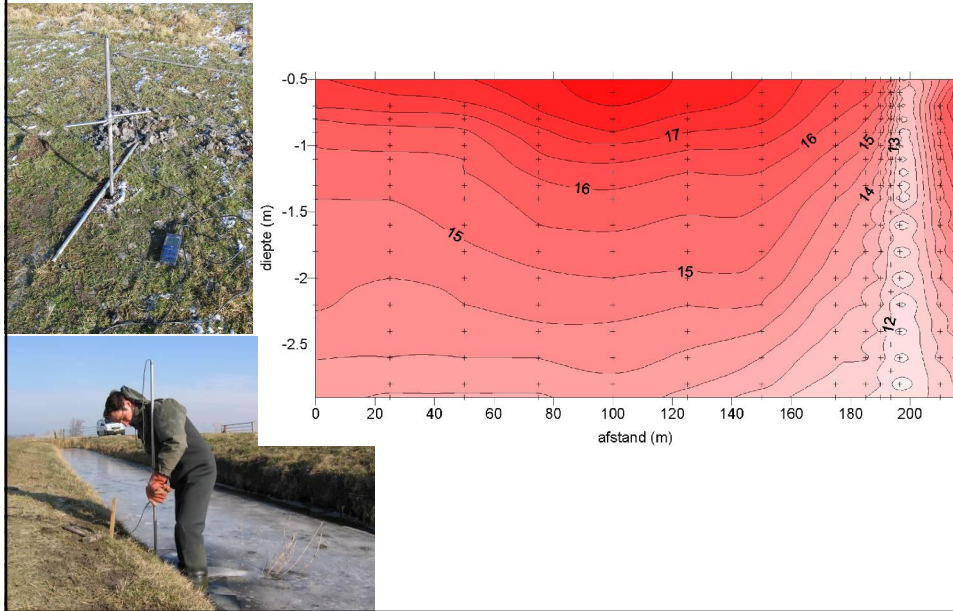

Simulation of salt groundwater towards wells

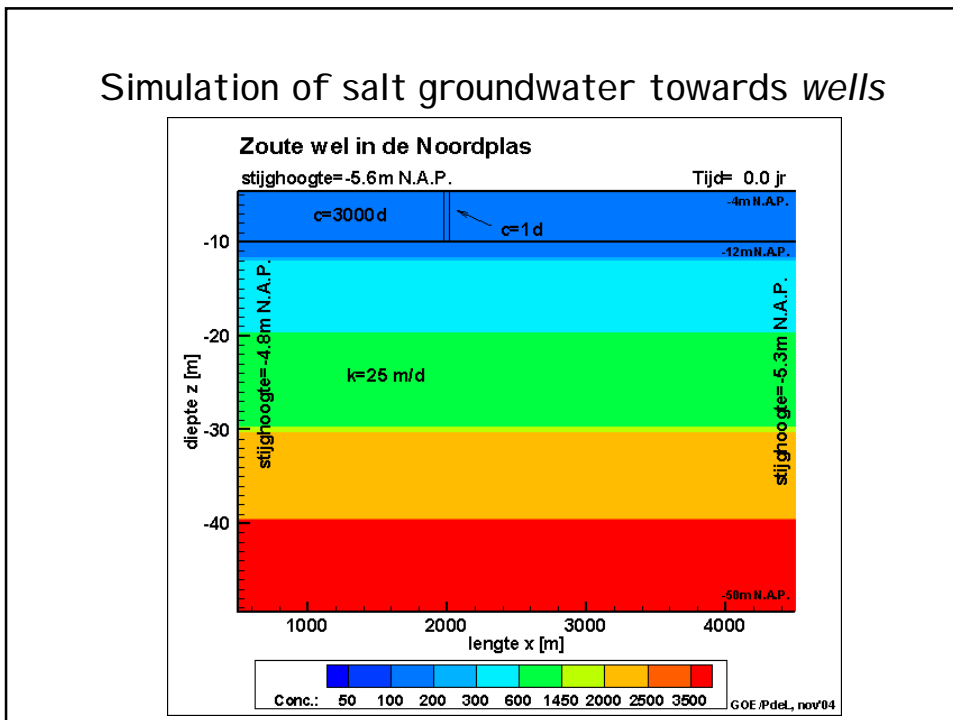

Risk of instable Holocene aquitards (2)

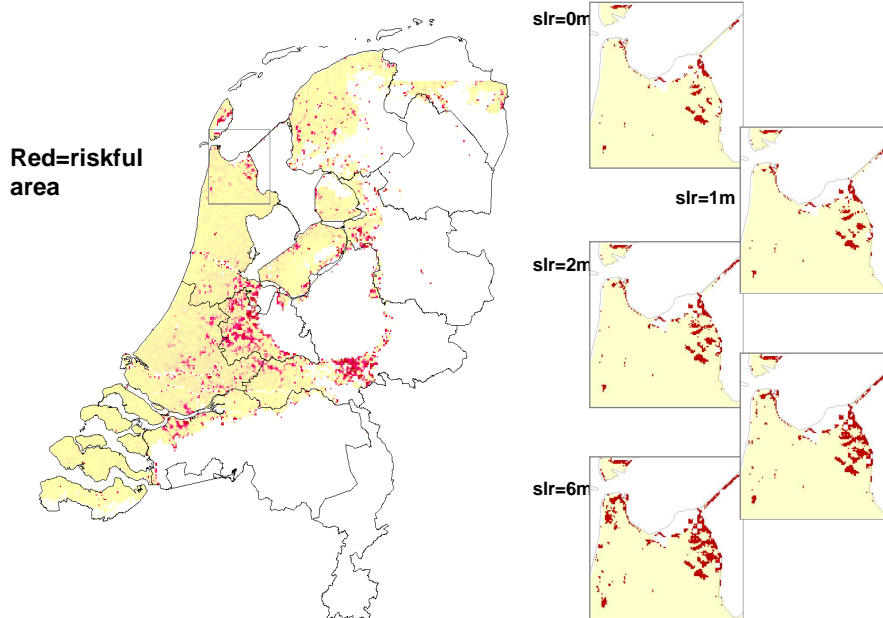

Quantification hydrogeological impacts of sea level rise

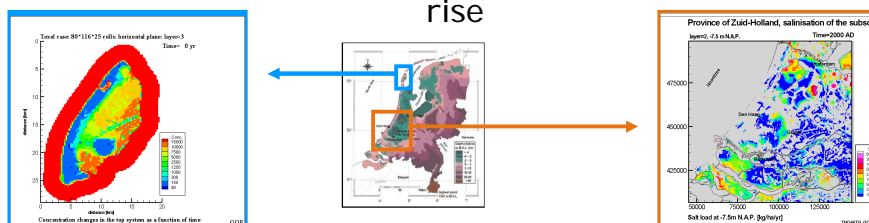

Situation at 2100 AD with sea level rise of 0.5m/century,

Including land subsidence at Zuid-Holland (max 1.0m/century)

	<u>Texel</u>	<u>Zuid-Holland</u>
Increase seepage (%)	+22	+4
Increase salt load (%)	+46	+34
Hinge area: from infiltration to seepage (% land surface)	+3	+5

Modelling effect sea level rise on salt water intrusion

**3D models
number cells
grid size**

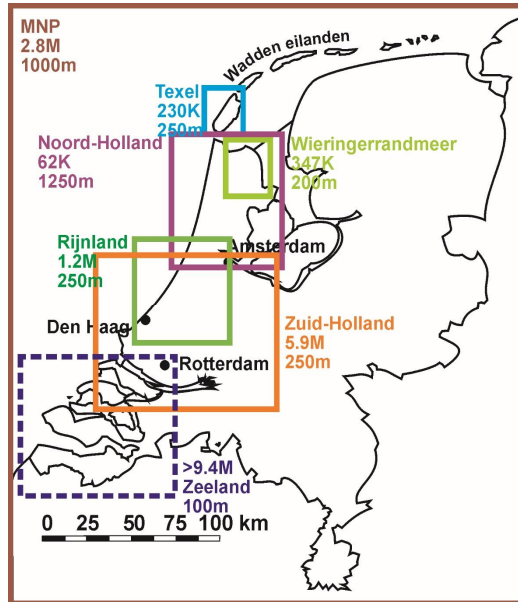

3D modelling

Characteristics 3D Cases (I): geometry & subsoil

Case	Kop van Noord-Holland	Texel	Wieringer-meerpolder	Rijnland
total land surface [km ²]	2150	130	200	1100
L _x *L _y modelled area [km]	65*51	20*29	23*27	52*60
depth system [m -N.A.P]	290	302	385	190
aquifer hydr.cond. [m/d]	5-70	5-30	15-40	12-70
aquitard hydr.cond. [m/d]	0.12-0.001	0.01-1	0.012-0.056	2.5E-4-0.8
porosity	0.35	0.3	0.25	0.25
anisotropy [k _z /k _x]	0.4	0.4	0.25	0.1
long. dispersivity α _L [m]**	2	2	2	1
# head&conc. observations	not applicable*	111	95	1632
characteristics head calibration	not applicable*	Δφ =0.24 m σ=0.77 m	Δφ =0.34 m σ=0.21 m	Δφ =0.60 m σ=0.77 m

* calibration with seepage & salt load in polders

**molecular diffusion=10⁻⁹ m²/s; trans. disp.=1/10 long. disp.

Characteristics 3D Cases (II): model parameters

Case	Kop van Noord-Holland	Texel	Wieringer-meerpolder	Rijnland (=391 EM RAM)
horizontal cell size [m]	1250*1250	250*250	200*200	250*250
vertical cell size [m]	10	1.5 to 20	2 to 70	5 to 10
total # active cells	~40.000	~126.000	~312.000	~1.200.000
# cells	41*52*29	80*116*23	116*136*22	209*241*24
# particles per cell	27	8	8	8
total time [yr]	1000	500	50	500

convergence head criterion= $10^{-5}/10^{-4}$ m
 flow time step $\Delta t=1$ year

Model of the island of Texel

Characteristics of the island of Texel (I)

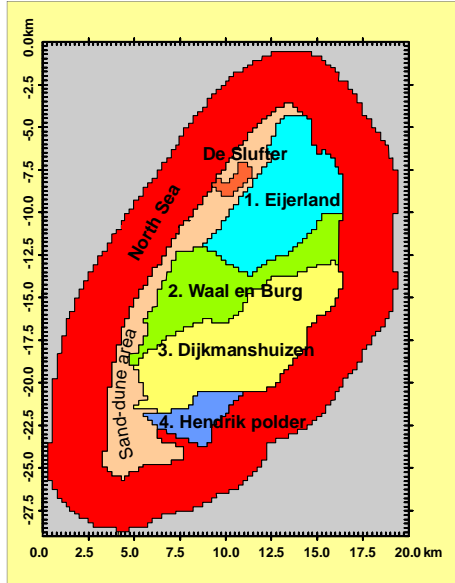

- Tourist island in summer time
- Land surface: 130 km²
- Polder areas:
 - 1. Eijerland
 - 2. Waal en Burg
 - 3. Dijkmanshuizen
 - 4. Hendrik polder
- Sand-dune area at western side
- 'De Slufter' is a tidal salt-marsh
- North Sea surrounds the island

Texel: present 3D chloride distribution

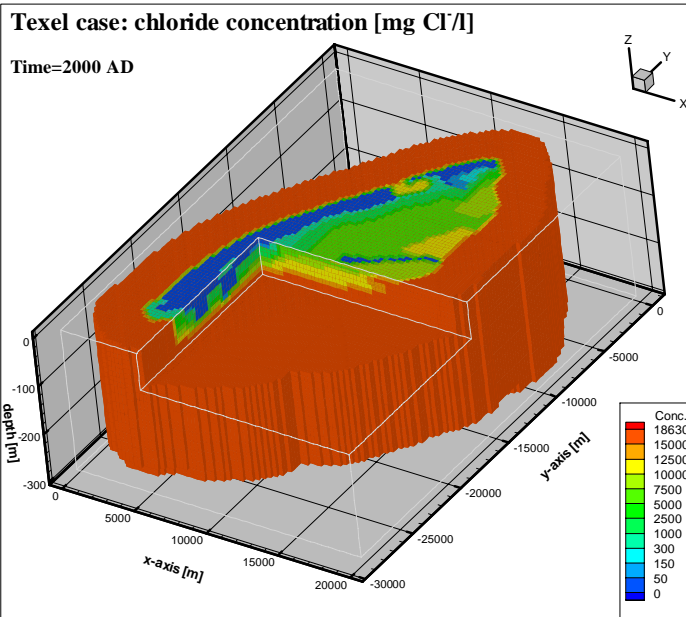

Texel: reference case=autonomous development

Texel

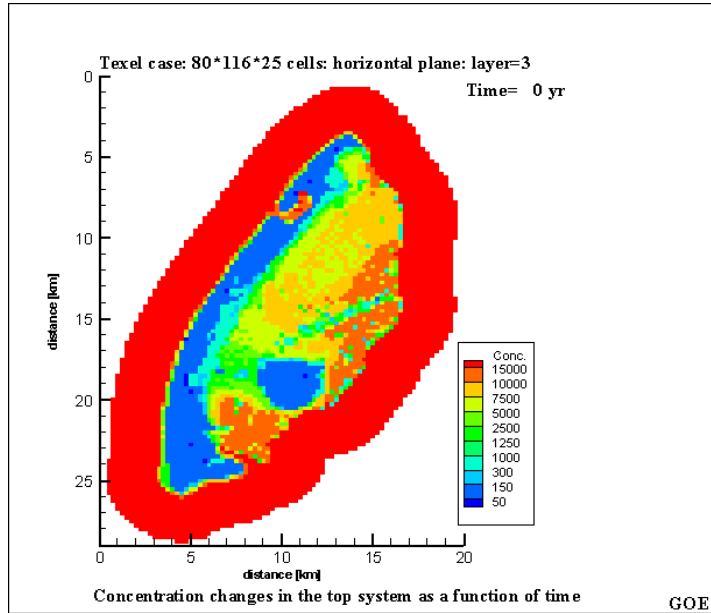

Texel: effect of sea level rise on salt load

Texel

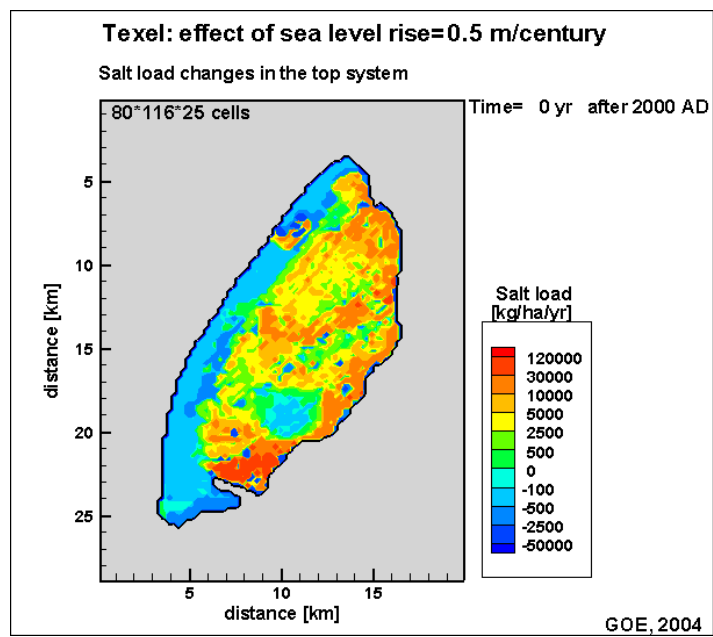

Texel: change in seepage of the four polders

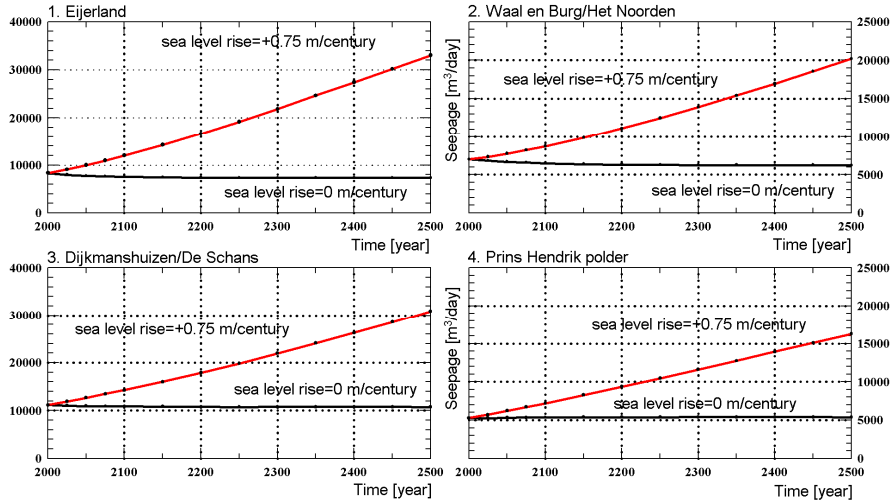

Texel: change in salt load of the four polders

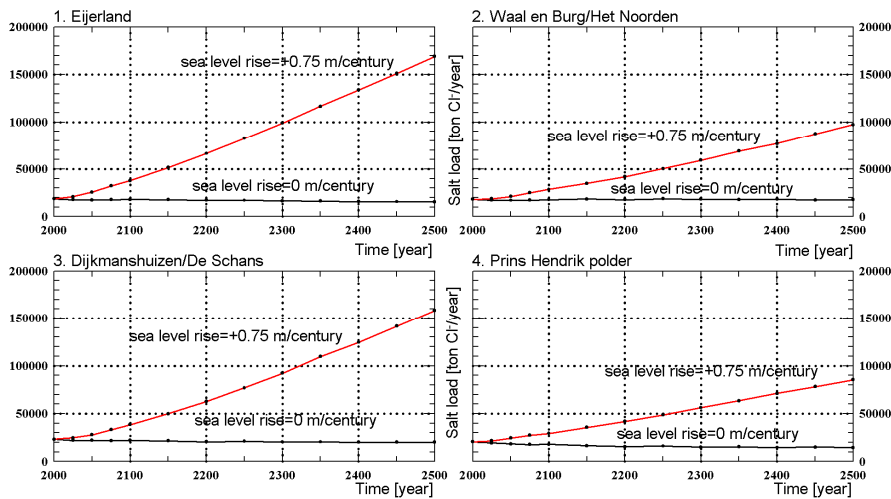

Model of the Province of Zuid-Holland

Case study: Province of Zuid-Holland

European water framework directive

“in 2015, state of all groundwaters and surface waters must be good“

Identification of all fresh groundwater bodies in the province

How fast is the salinisation process?

More seepage, more salt load?

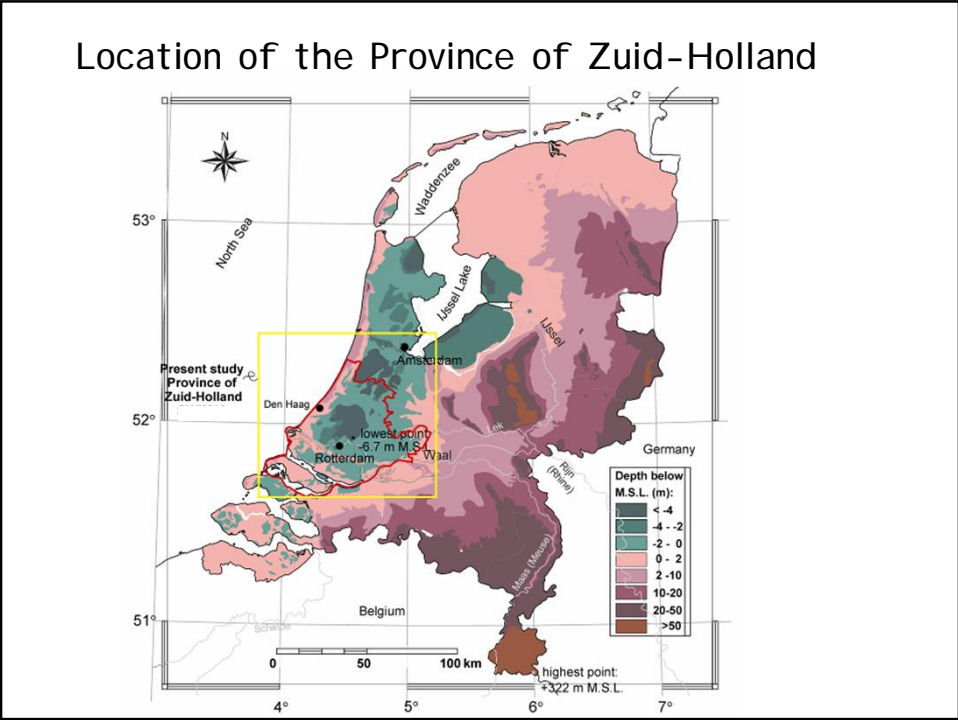
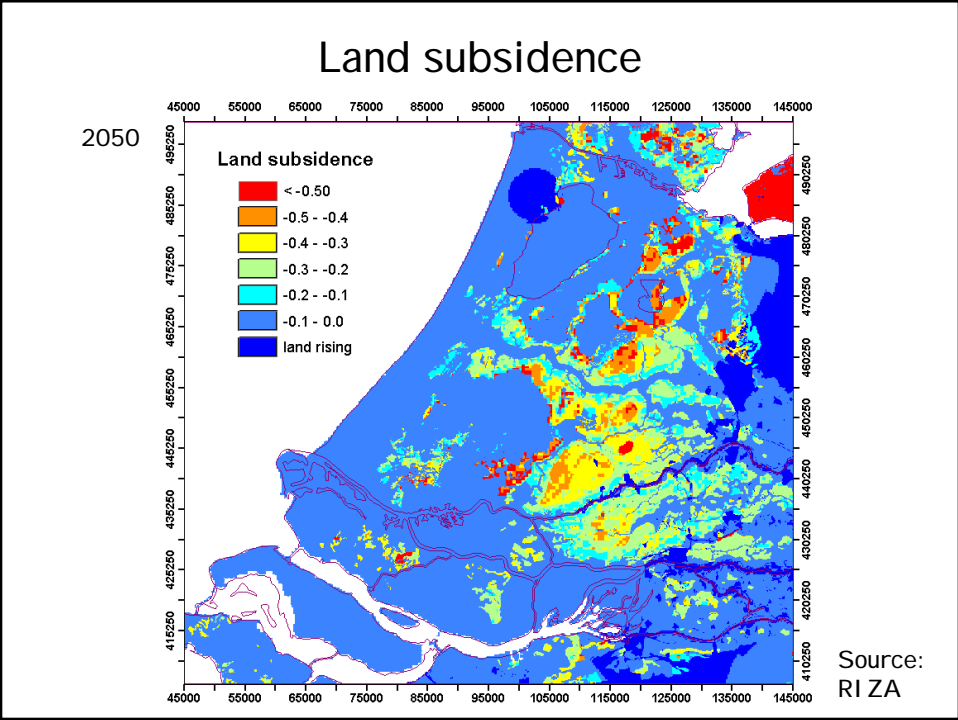

Numerical model description

- variable-density groundwater flow
- coupled solute transport
- MOCDENS3D
- area: 100km * 92.5km * 300m depth
- 400 * 370 cells, 40 layers
- ~4 million active cells
- uses most accurate Dutch 3D subsurface schematization available
- 9 aquifers and aquitards
- uses 5772 chloride concentration measurements

Position and name of aquitards

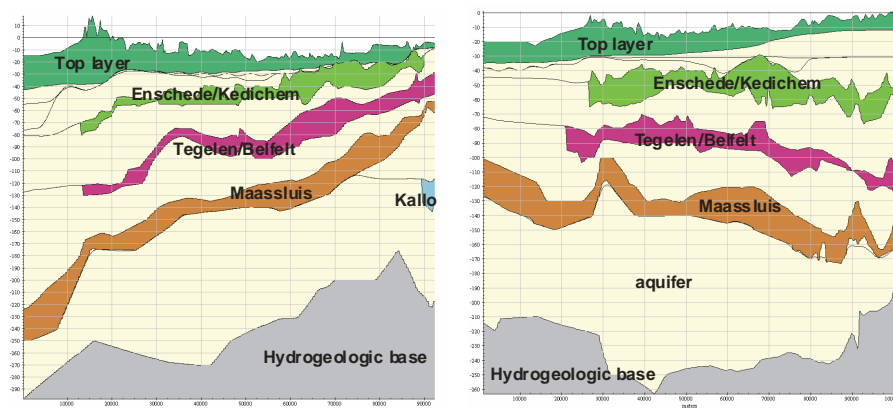

3D interpolation of chloride-concentration

Chloride concentration measurements in Province Zuid-Holland, used in 3D-density matrix

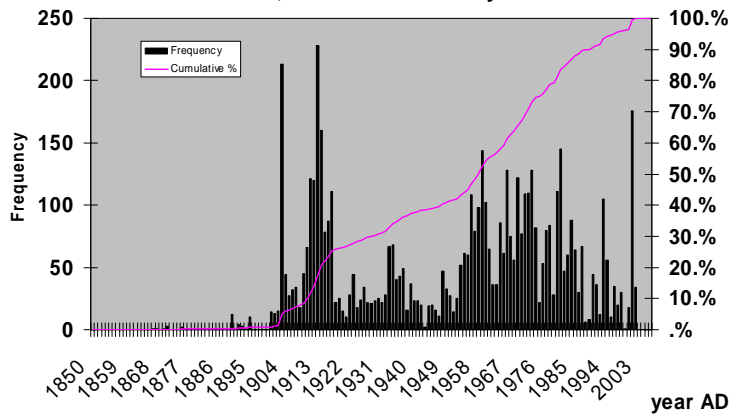

3D interpolation of chloride-concentration

Histogram: depth Chloride measurements

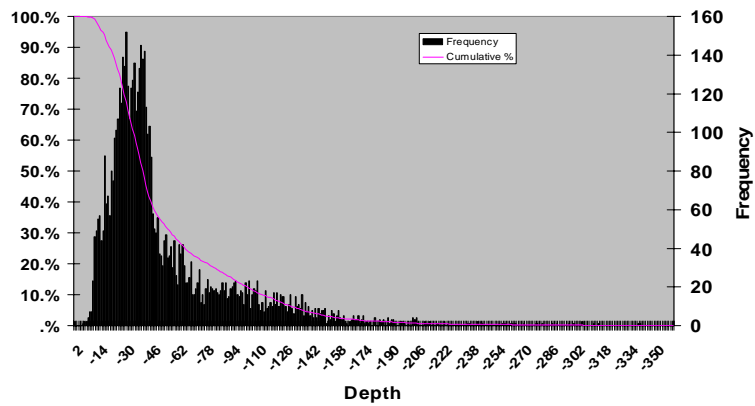

Initial chloride distribution

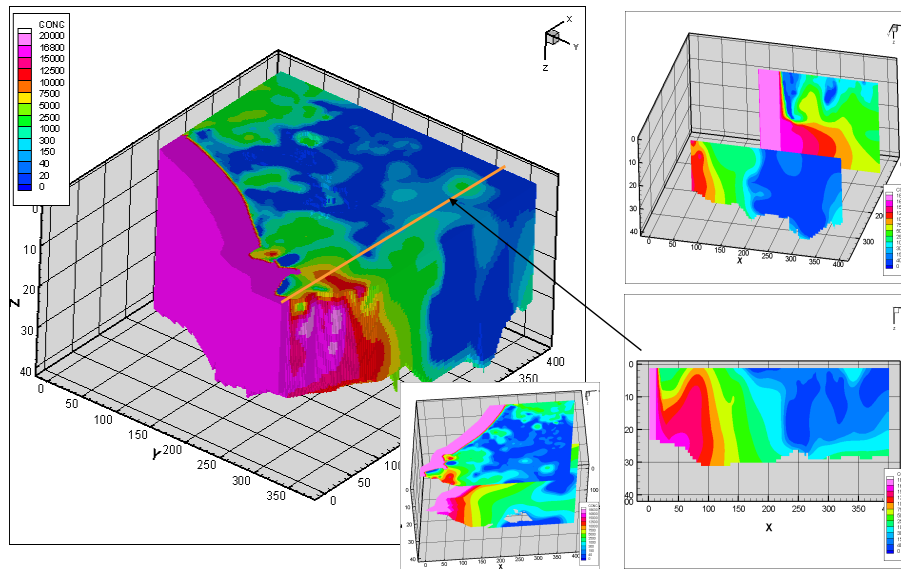

Present freshwater volume

27 billion m³

36% fresh, 14% brackish, 50% saline

Results: Chloride conc. in 200 yrs

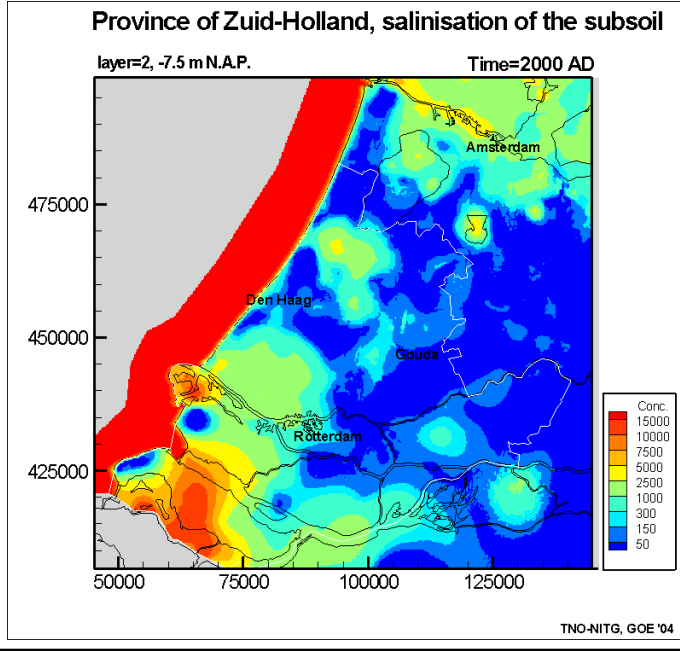

Results: Chloride conc. in 200 yrs

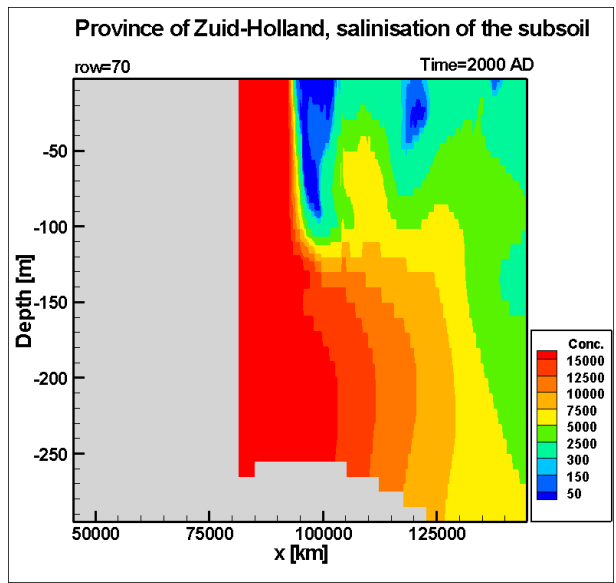

Results: freshwater head and seepage at 2000 AD

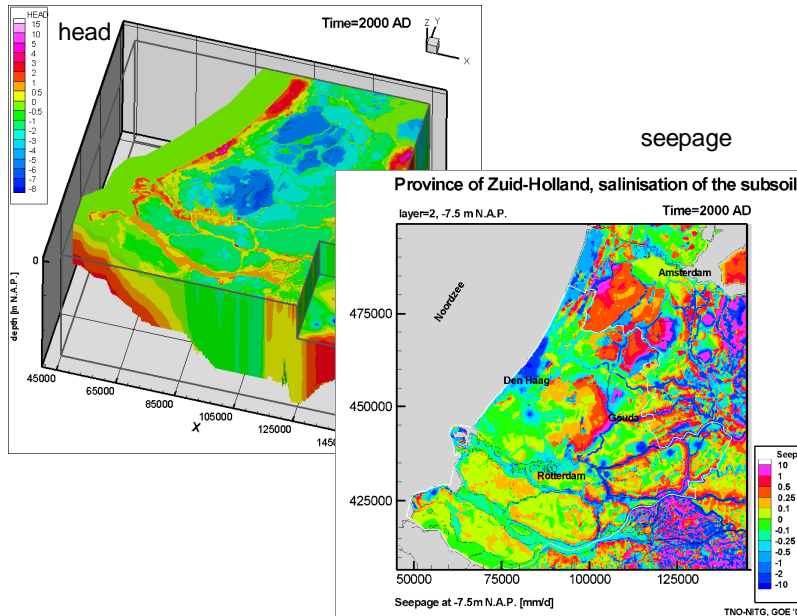

Results: Salt load in 200 yrs

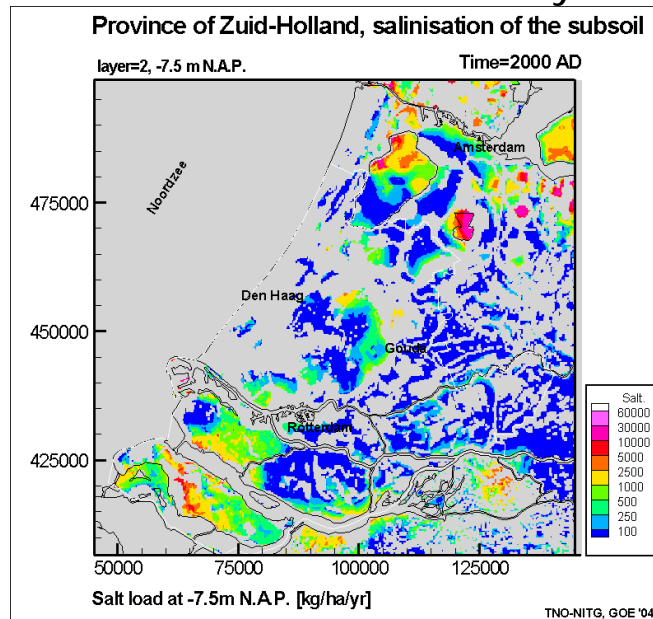

Effect sea level rise, change in natural groundwater recharge and land subsidence on freshwater head in aquifer

Some regional modelling results

Freshwater head at -12.5 M.S.L.

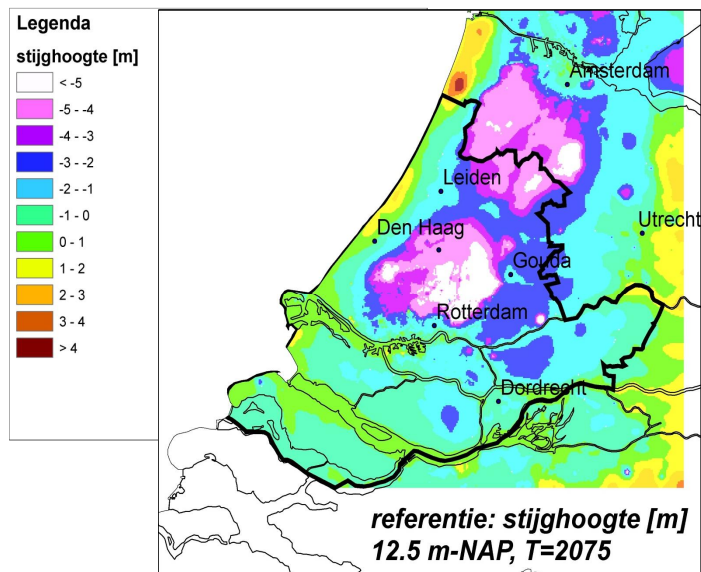

Difference in freshwater head on op -12.5 N.A.P.: G scenarios

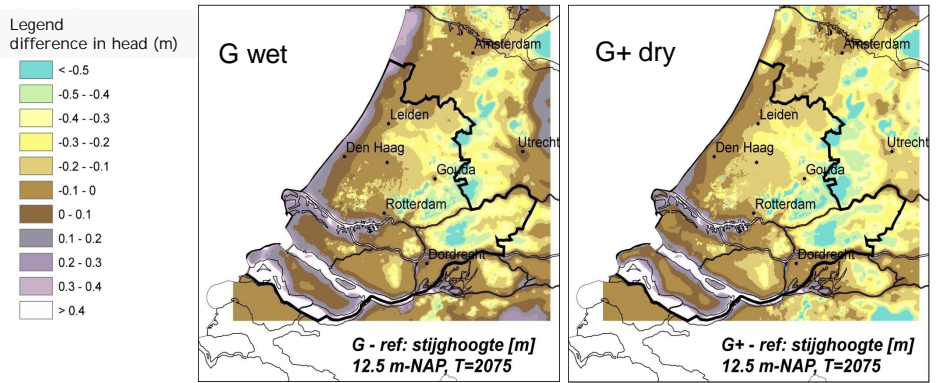

Sea level rise is 60 cm

Including change in natural groundwater recharge

Difference in freshwater head on op -12.5 N.A.P.: W scenarios

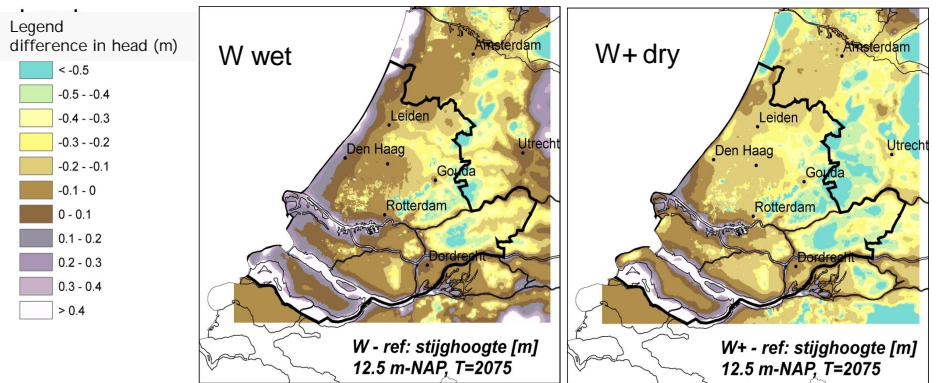

Sea level rise is 85 cm

Difference in freshwater head on -12.5 N.A.P.: W scenarios

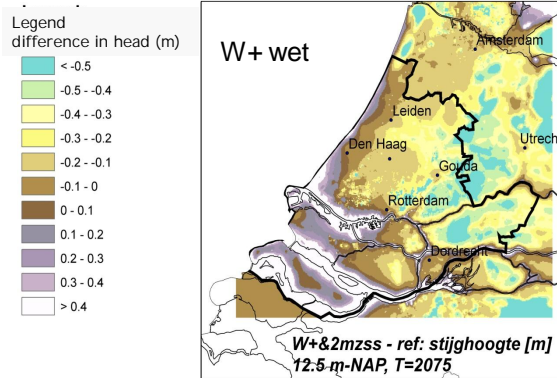

Sea level rise is 200 cm

Salinisation/freshening Netherlands?: Present situation

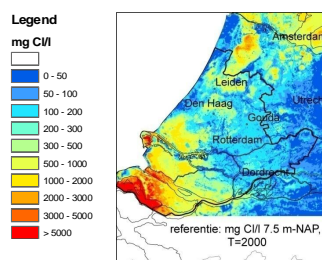

modelstudy

Salinisation/freshening Netherlands?: Autonomous processes

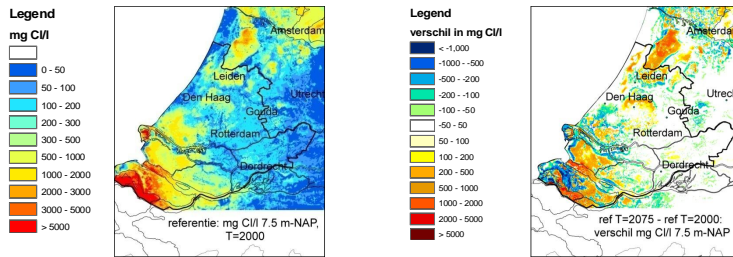

modelstudy

Salinisation/freshening Netherlands?: climate change

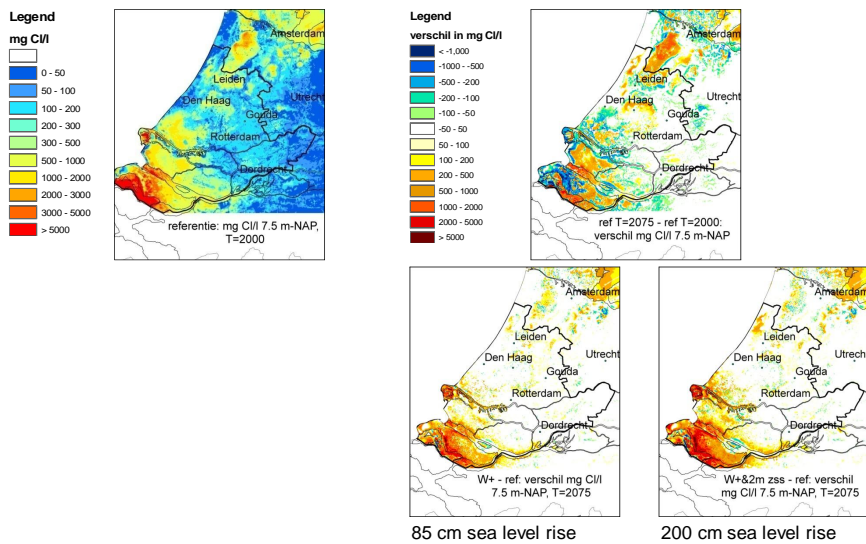

modelstudy

Effect climate scenarios in 2075 on

freshwater head

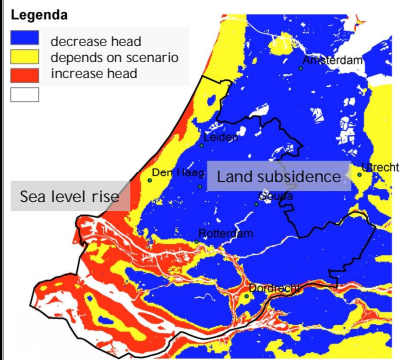

Increase or decrease head for all climate scenarios G, G+, W, W+

salinisation

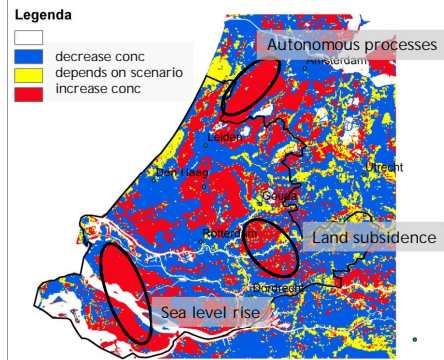

Increase or decrease concentration for all climate scenarios G, G+, W, W+

Modelstudie PZH

Rainwater lens

Rainwater lenses in an agricultural setting

Shallow dynamic freshwater bodies flowing upon brackish-saline groundwater

- density dependent
- dynamics: seasonal & long-year

Salinisation of the phreatic groundwater in Zeeland

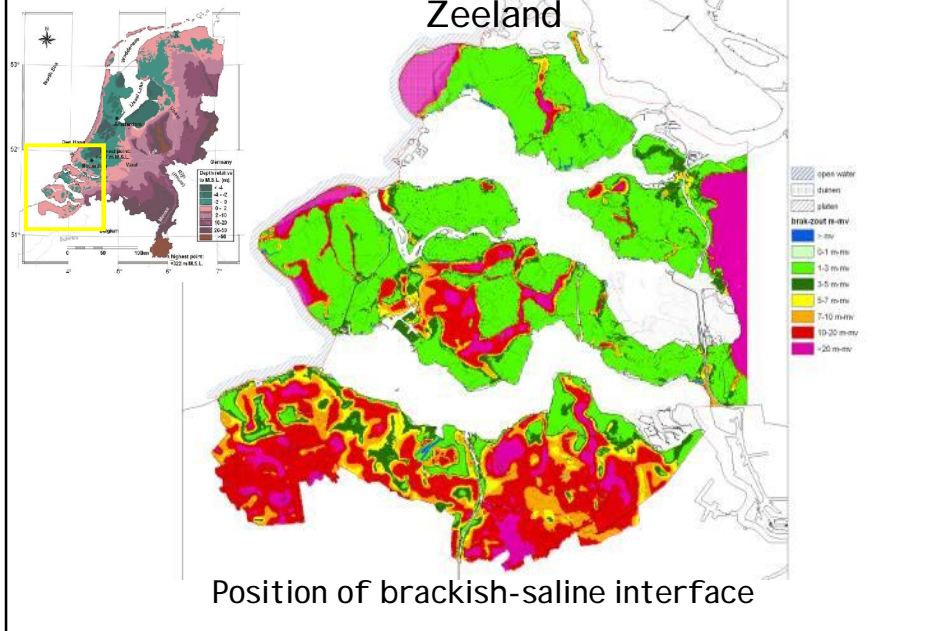

Salinisation of the phreatic groundwater in Zeeland

Dynamic rainwater lenses floating on saline groundwater

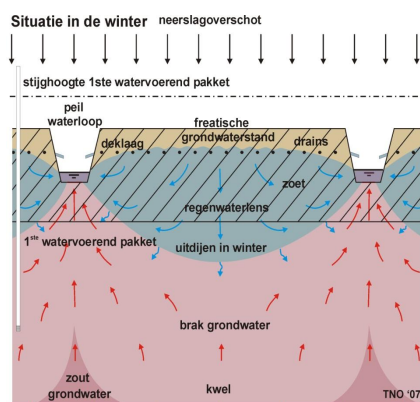

thickness rainwater lens varies due to the dynamics in seasonal and long-year natural groundwater recharge

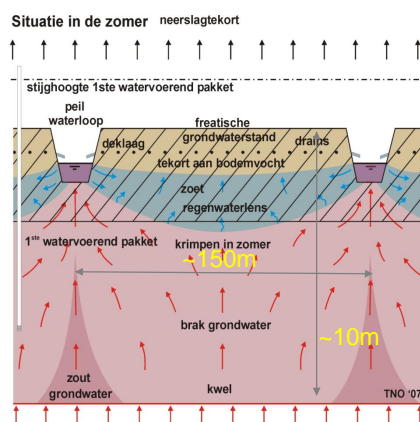

Factors controlling fresh-salt interface

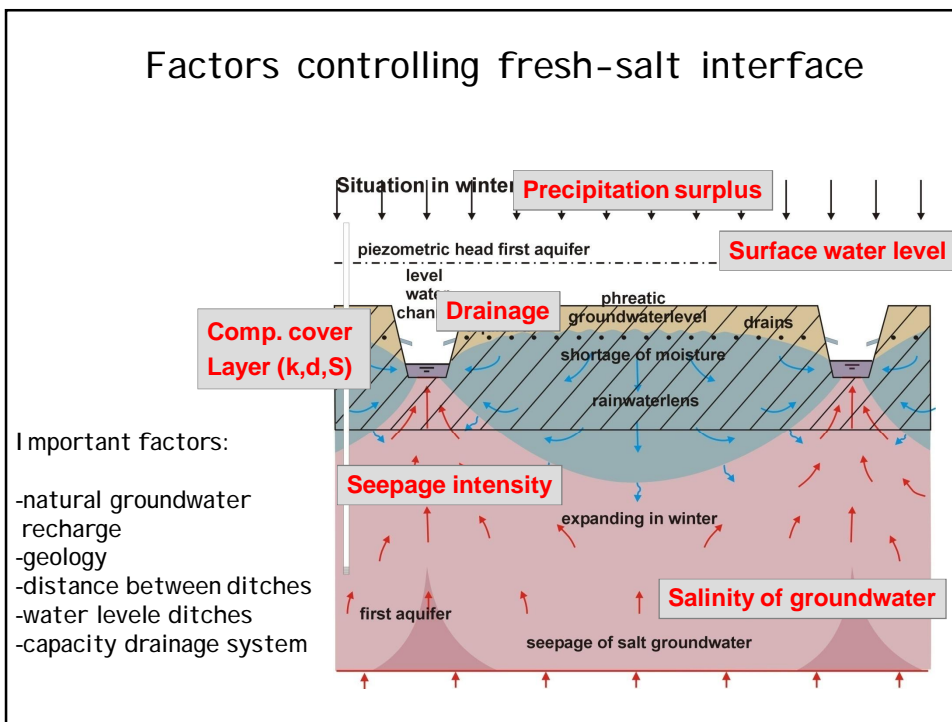

Salinisation surface water

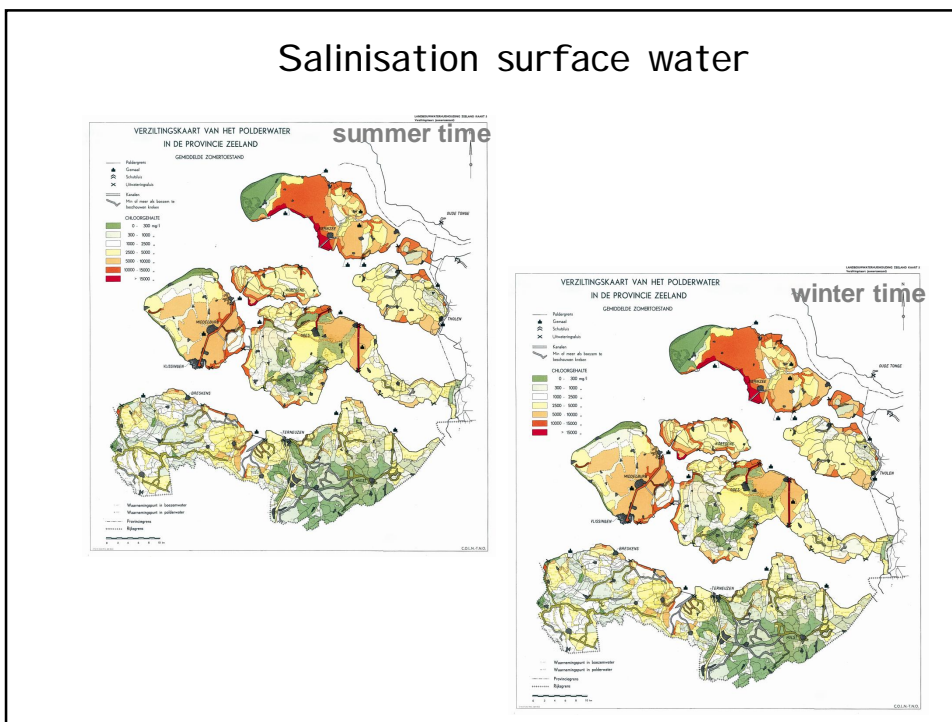

Position of the ground surface

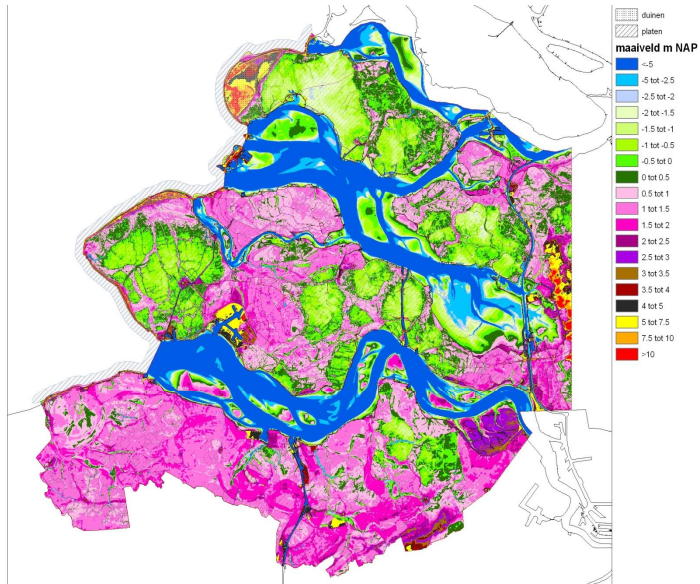

Salinisation surface water

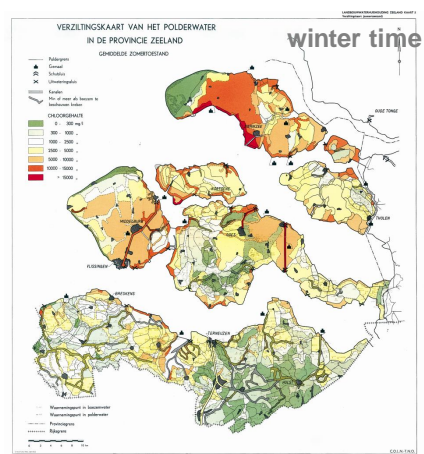
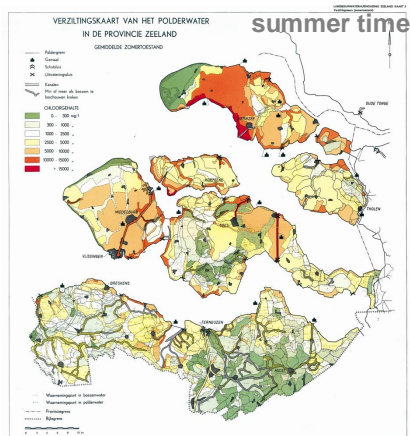

Problem definition dynamic freshwater lenses



Salt in the agricultural plots originates from:

- surface water system (irrigation water)
- groundwater system (salt load to the root zone)

The salinisation will increase due to:

- sea level rise
- climate change
- water level management



How to tackle the problem?

Field measurements at parcels

- fresh-brackish-salt interface at local scale using T-EC-probe and later CVES and ERT
- groundwater level and quality
- surface water level and quality



Modelling

- density dependent groundwater flow
- two different scales:
 - regional scale: transect perpendicular at coast
 - local scale: parcel between two ditches



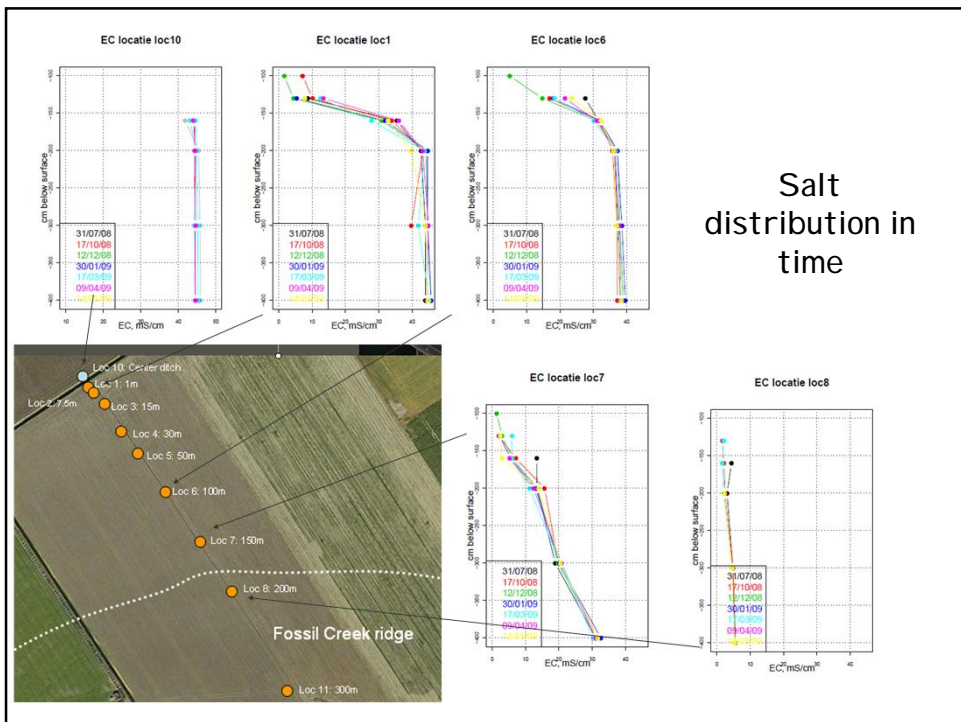

- TEC
- sampling
- EM31
- CVES
- HEM
- ECPT
- Numerical models (2D and 3D)

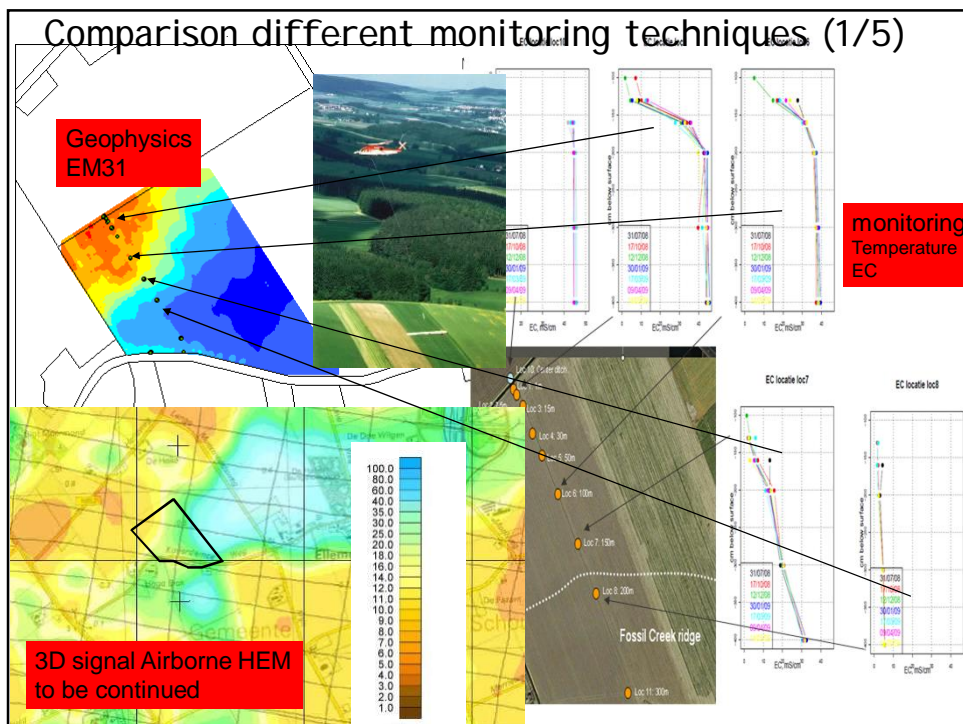

Local 3D model of the agricultural plot

Modelling:

- variable-density
- 3D, non-steady
- groundwater flow & coupled solute transport
- model cell size: 5*5m²

Code:

MOCDENS3D

Assessing effects:

- autonomous salinisation
- sea level rise
- changing recharge pattern
- (adaption measures)

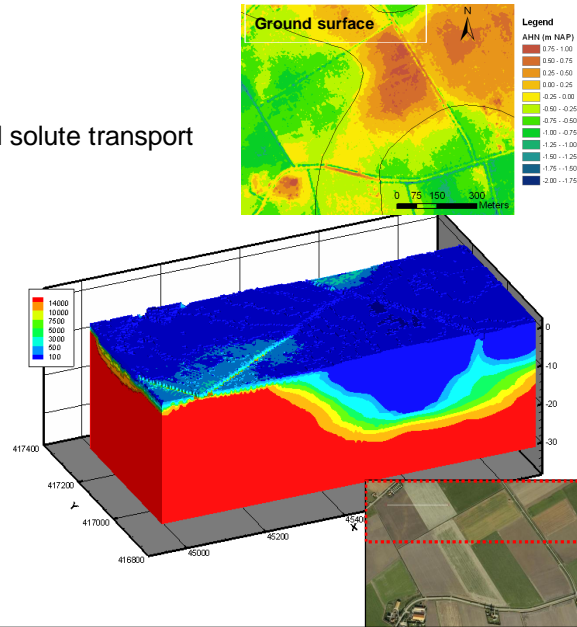

Comparison model with EM31, CVES, profiles

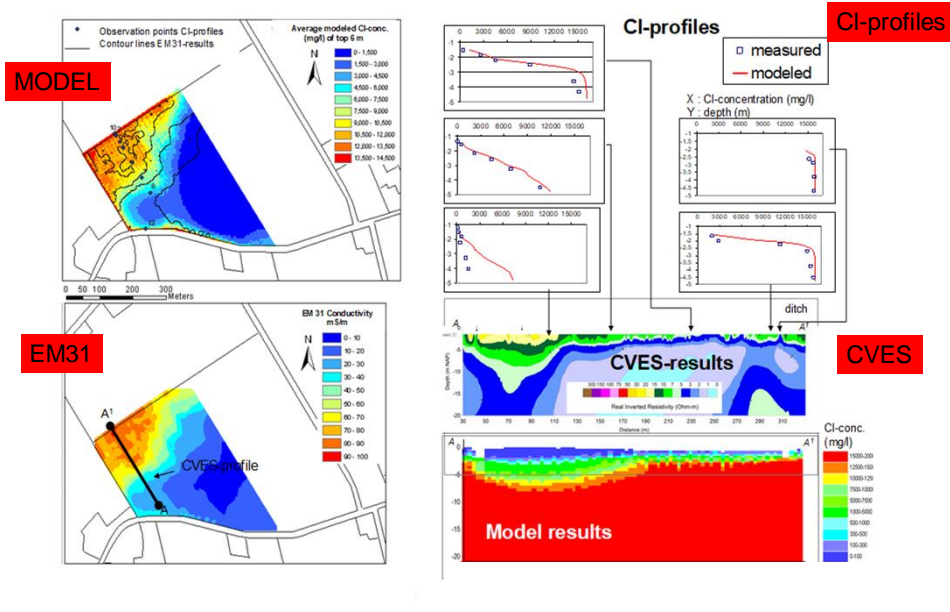

Comparison 3D model and CVES

CVES

Site 11 - Renesse

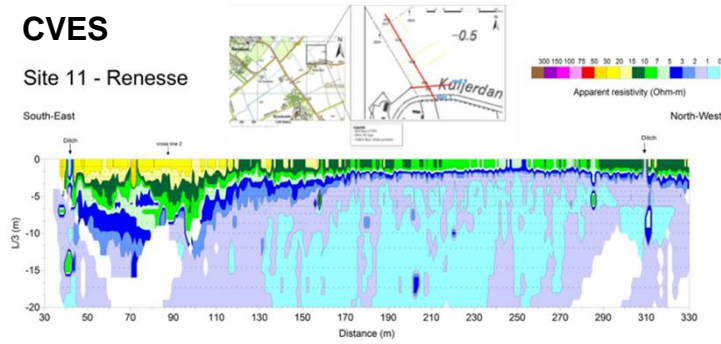

MODEL

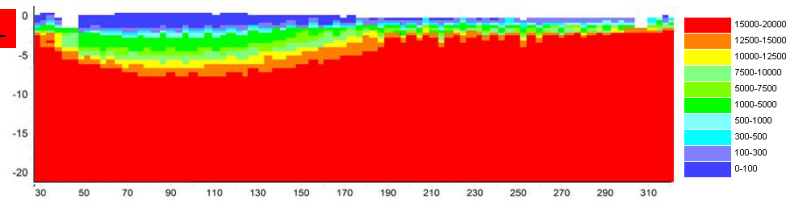

HEM data

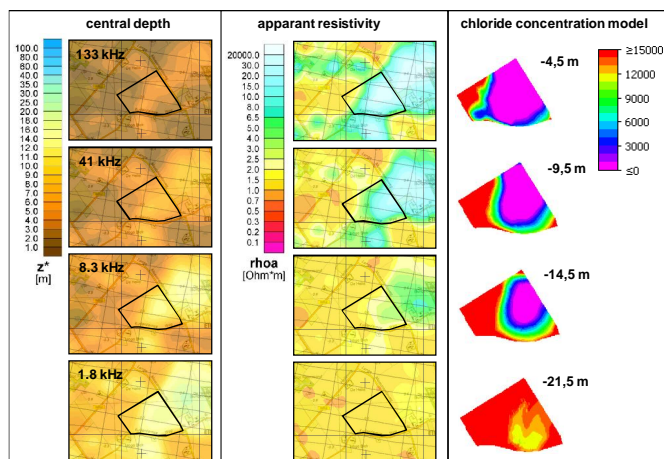

Climate change scenario (dry): model result

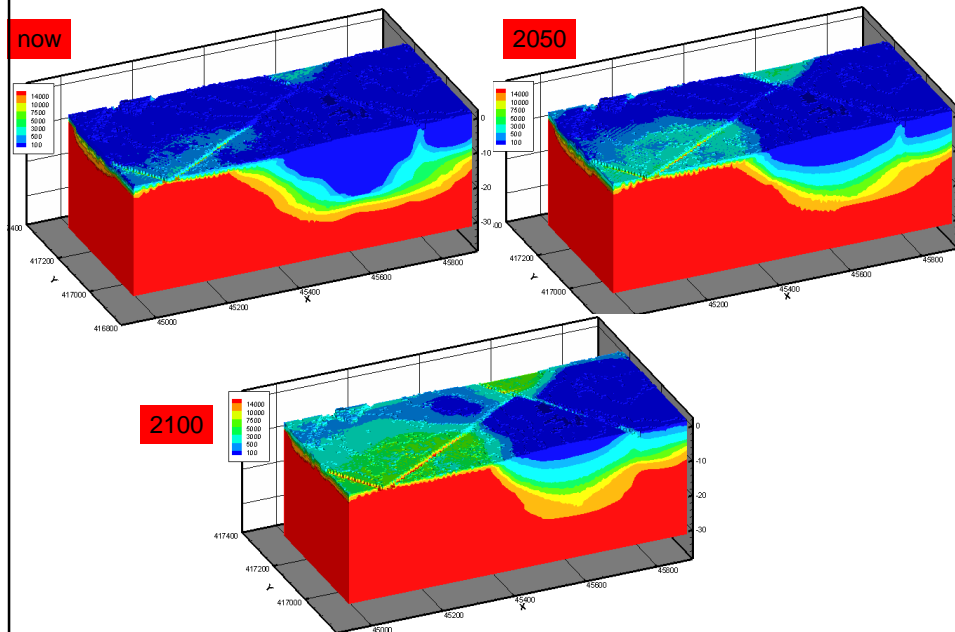

To be continued...

- Implementing more realisations of 3D geology and initial 3D fresh-saline
 - Analyse the differences
- Running climate change scenarios (on national and regional level)
 - Effect on surface water (salt load)
 - Effect on root zone (rainwater lenses)
 - Effect on freshwater volumes (drinking water)
- Compare model results of different scales and give recommendations

Model the dynamics of fresh-brackish-salt interface

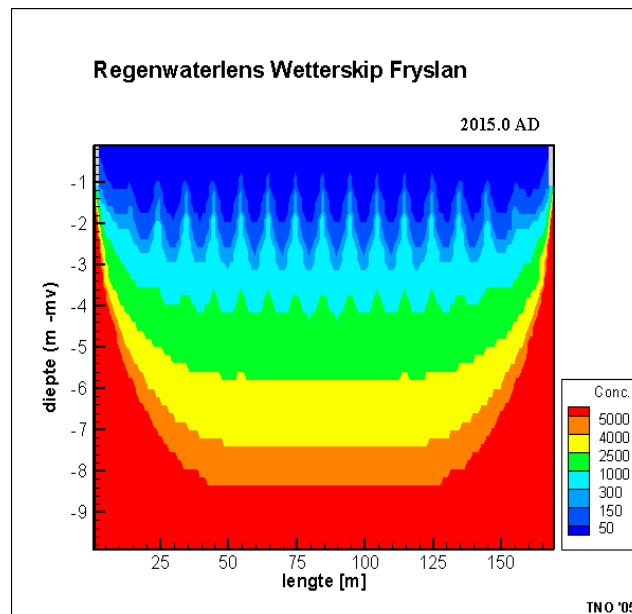

Model the dynamics of fresh-brackish-salt interface

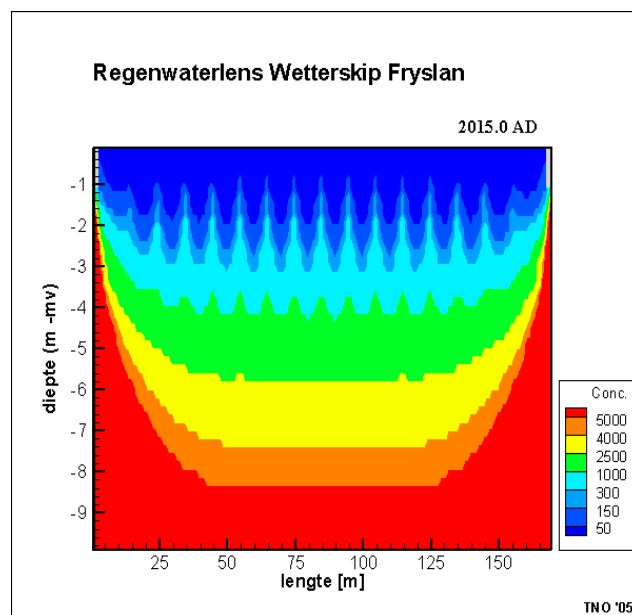

Thickness of the lens and salt load to surface water varies

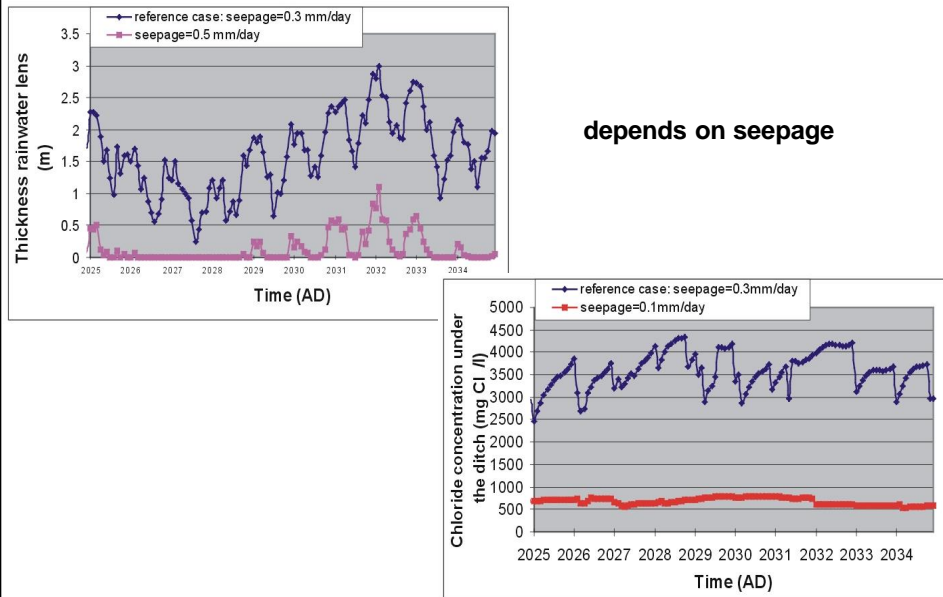

Conclusions (salinisation Dutch aquifers):

- Salinisation in the Netherlands is a non-stationary process
- Three physical processes threaten the Dutch aquifers:
 - autonomous development
 - land subsidence
 - sea level rise
- Increase in seepage and salt load can be severe during the coming 50/100 years
- Modelling techniques are available to assess possible effects

Recommendations (salinisation Dutch aquifers):

- Number of quality measurements should be increased
- Feasibility study is necessary to implement potential technical measures to compensate salt water intrusion

What is Submarine Groundwater Discharge (SGD)?
any flow of water out across the sea floor

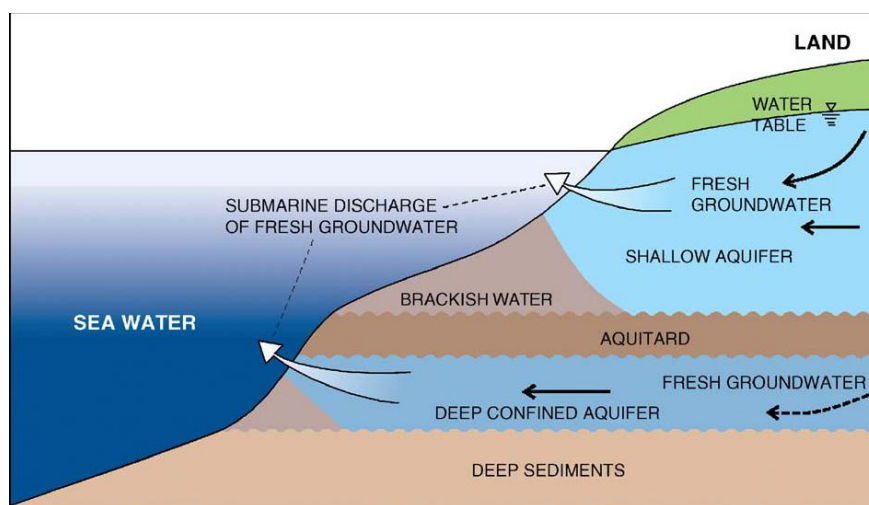

Burnett et al, 2006

Why study SGD?

Nutrients are transported from land to sea via SGD pathway

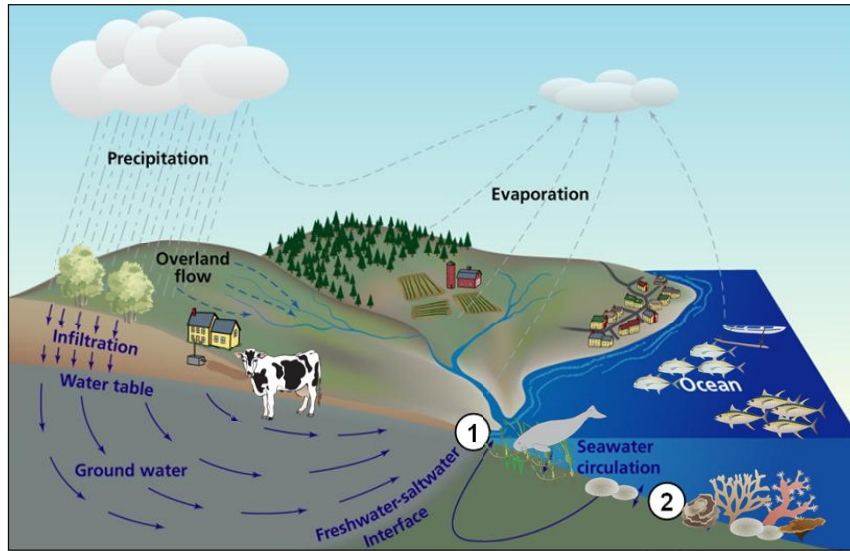

Symbols: IAN.umces.edu

Why study SGD?

Nutrients are transported from land to sea via SGD pathway

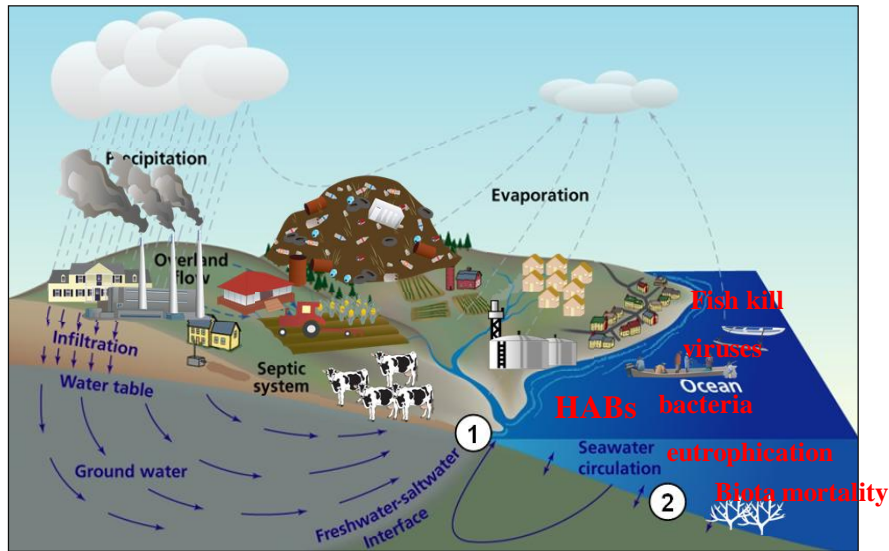

Symbols: IAN.umces.edu

Philippines

Submarine Groundwater Discharge

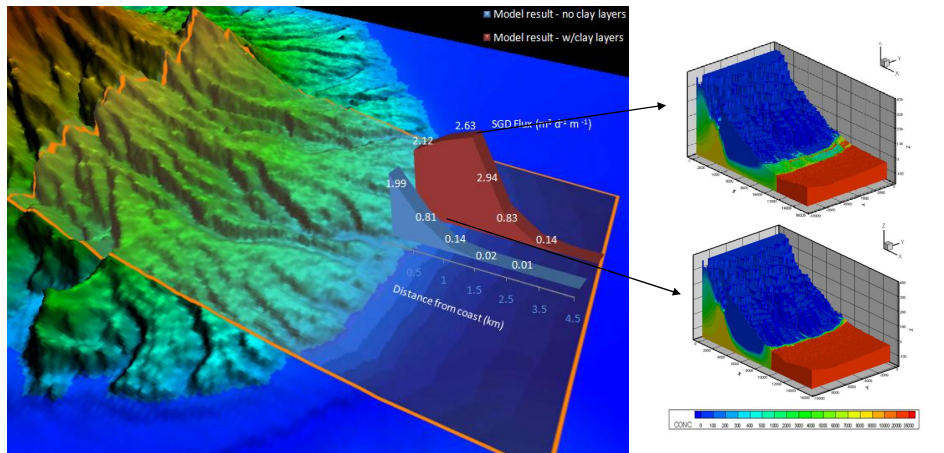
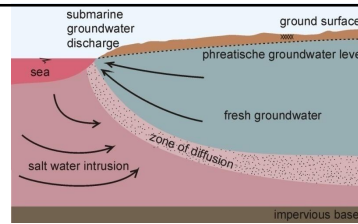

Conclusions (modelling of variable-density flow)

- Don't use the Henry problem to test your variable-density code
- Use enough cells to model the Hydrocoin and Elder problem

For modelling 3D systems:

- Remember the Peclet discretisation limitation for cell sizes (unless you're using the method of characteristics!)
- Longitudinal dispersivity should not be too large (e.g. <10m)
- It's important to derive a very accurate density distribution (as that significantly effects the velocity field!)
- Watch out for numerical problems at the outflow face to the sea

Challenges for the future

- Improve the 3D density matrix, e.g. by more types of measurements
- Implement effect of climate change and sea level rise on coastal aquifers
- Optimisation of (ground)water management in coastal aquifers by using 3D variable-density flow models
- Improve calibration of 3D models by using transient data of solute concentrations
- Incorporate reactive multicomponent solute transport

Solutions

Possible measures to compensate salt water intrusion

1. Land reclamation in front of the coast
2. Inundation of low-lying polders
3. Extraction of saline/brackish groundwater
4. Infiltration of fresh surface water
5. Creating physical barriers

1. Rijnland model: land reclamation case

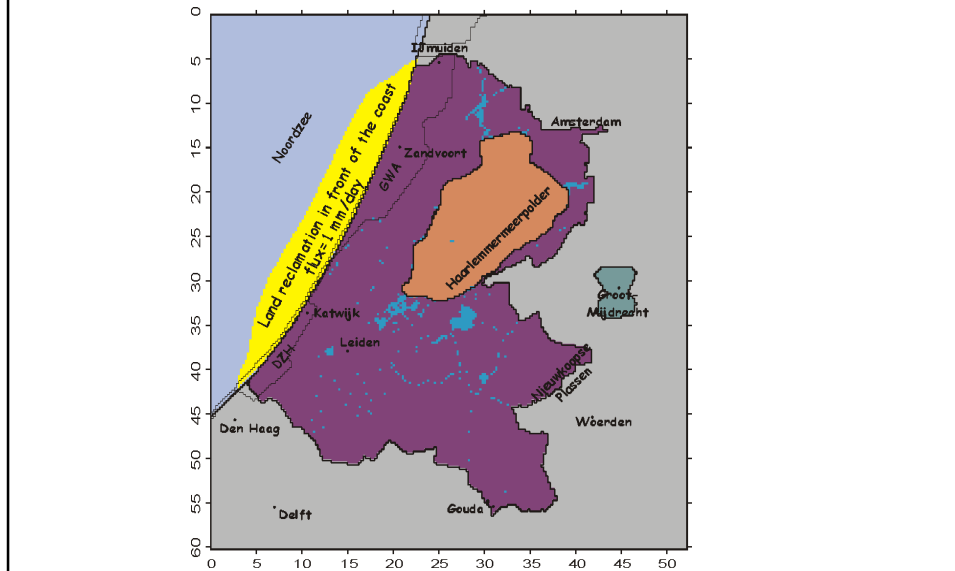

1. Land reclamation in front of the coast

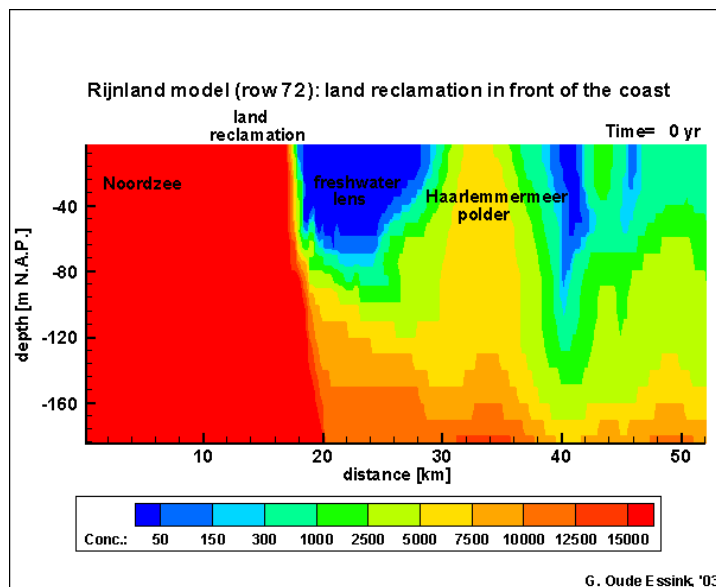

2. Rijnland model: I nundation Haarlemmermeerpolder

Calculated present phreatic water head

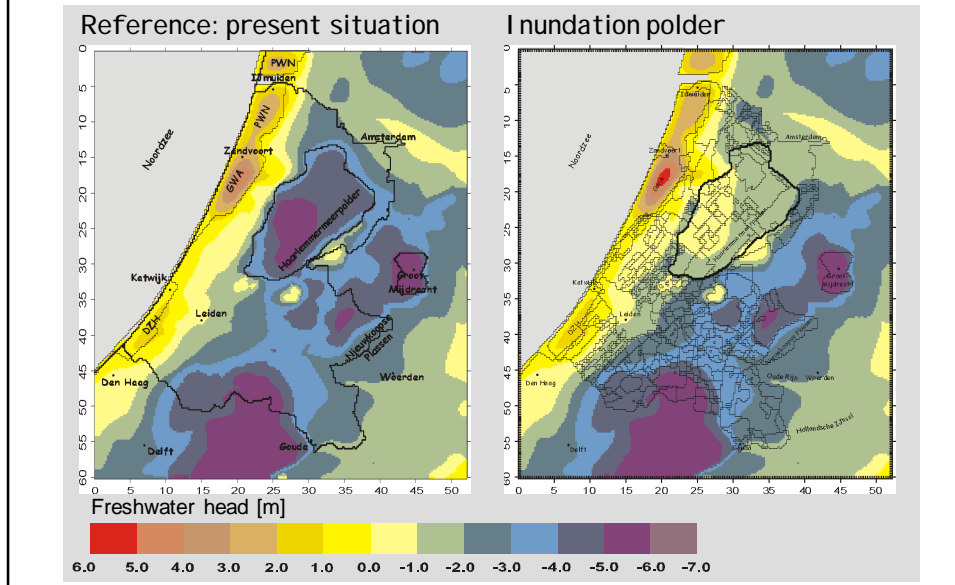

2. Rijnland model : I nundation Haarlemmermeerpolder

Calculated seepage and infiltration on -10 m M.S.L.

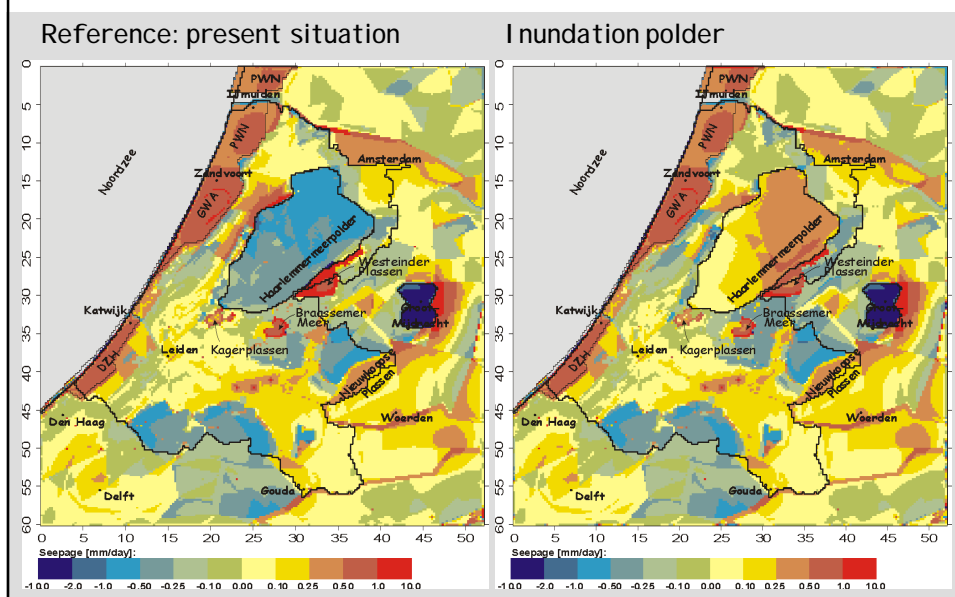

2. Rijnland model: Inundation Haarlemmermeerpolder Calculated salt load on -10 m M.S.L.

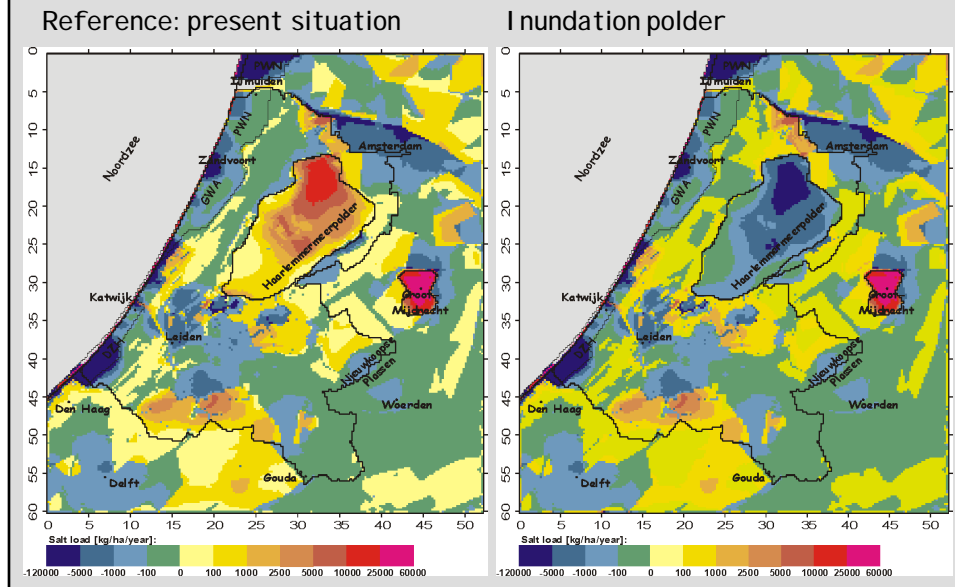

2. Rijnland model: Inundation Haarlemmermeerpolder

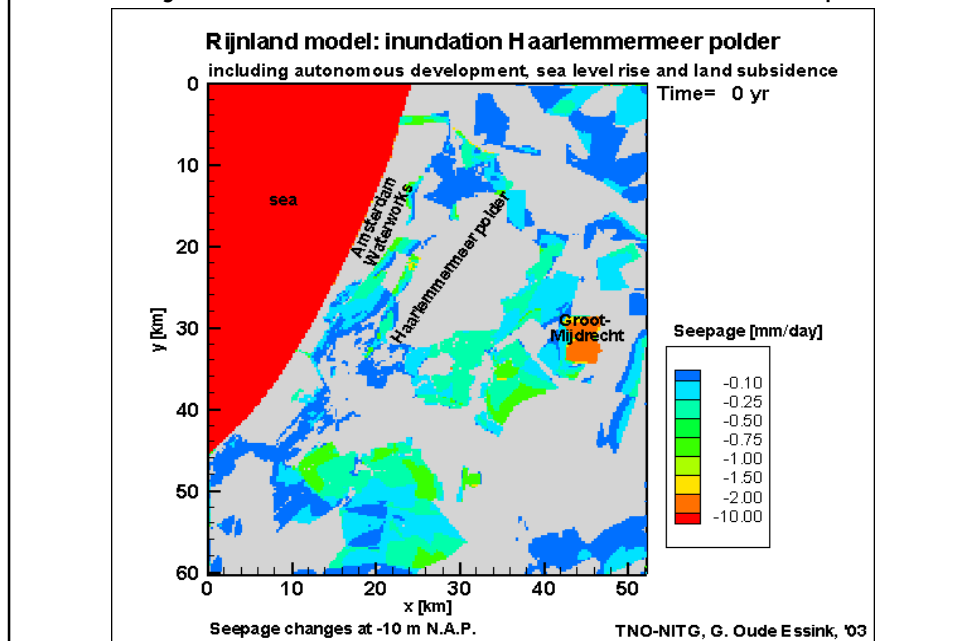

2. Rijnland model: Inundation Haarlemmermeerpolder

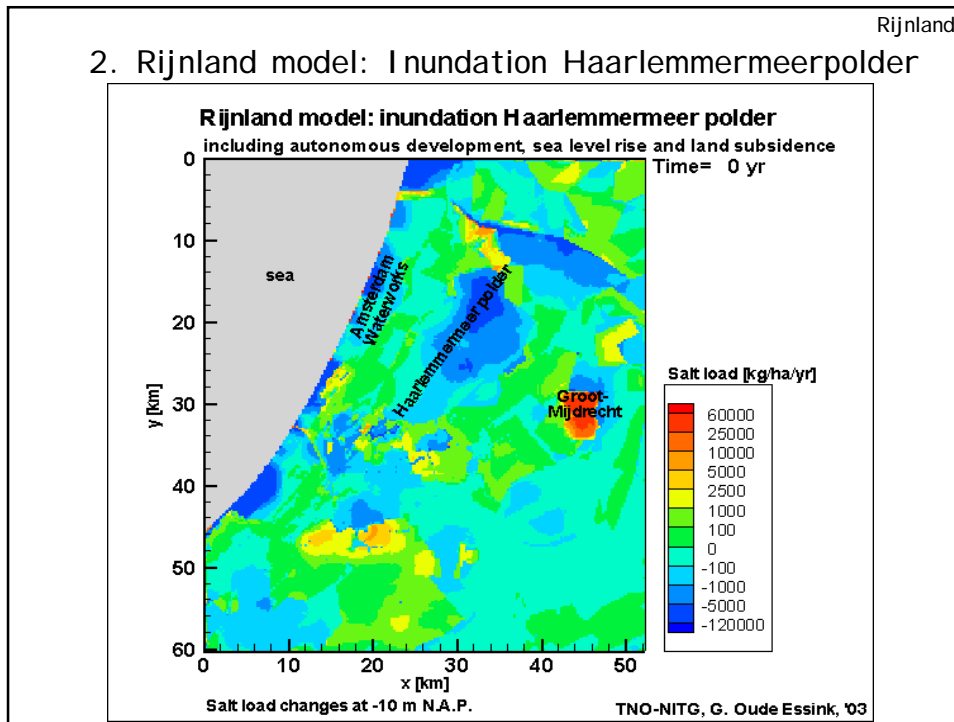

2. Rijnland model: Inundation Haarl.polder (conc, 500 jr)

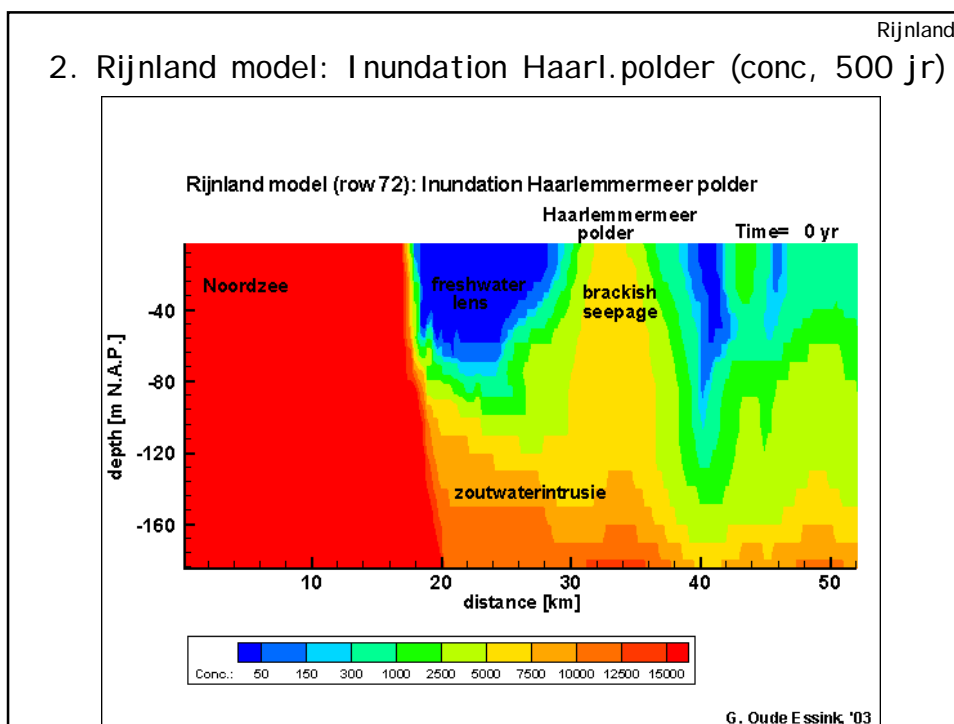

4. Injection of fresh water (conc, 1000 yr)

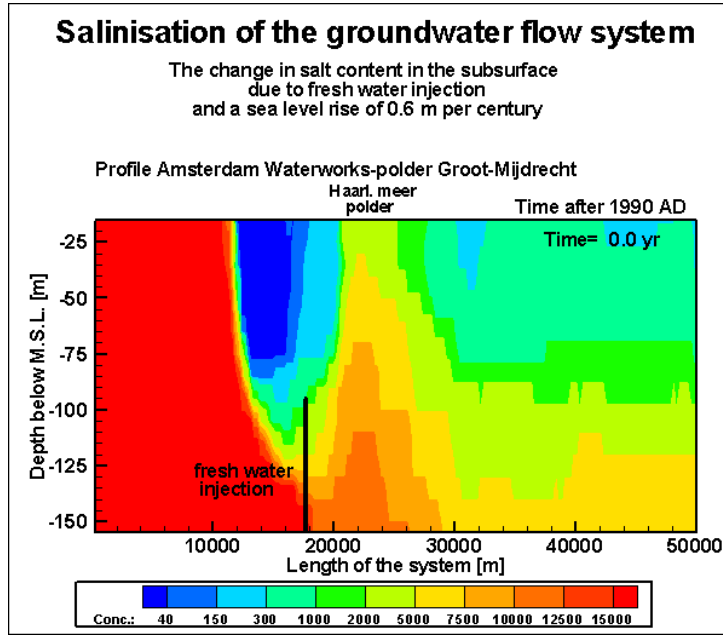

5. Physical barrier (conc, 1000 yr)

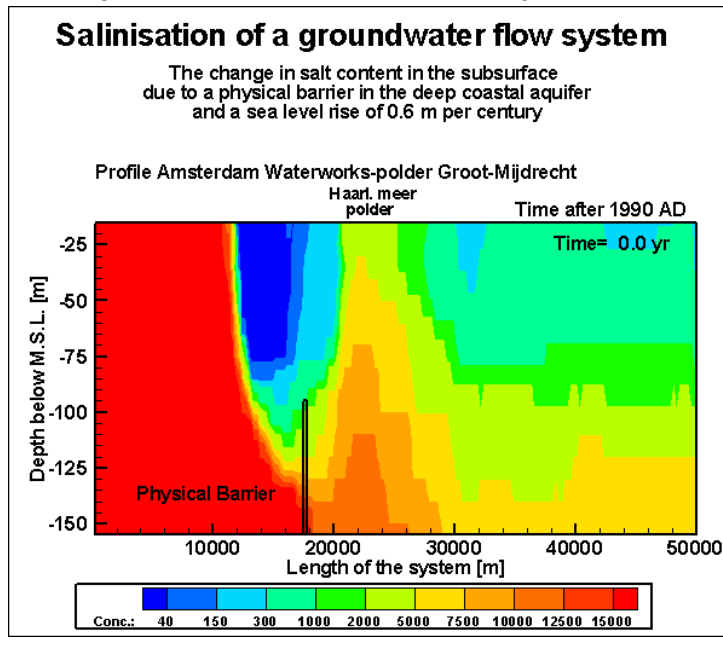

5. Physical barrier (conc, 1000 yr)

Salinisation of the groundwater flow system

The change in salt content in the subsurface due to a physical barrier in the deep coastal aquifer and a sea level rise of 0.6 m per century

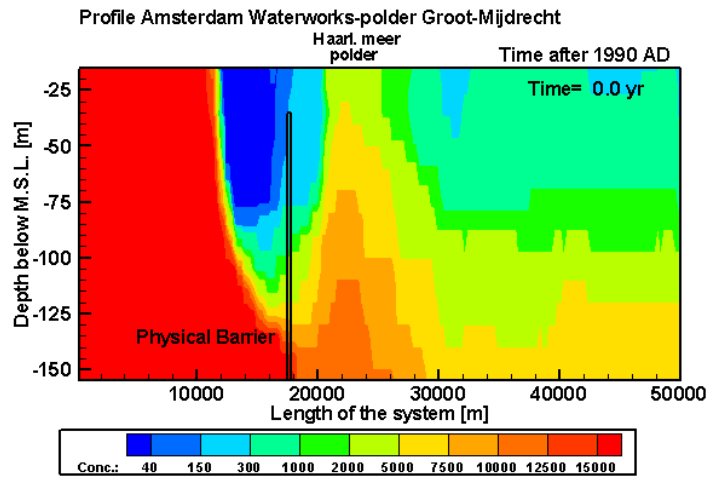

Solute transport models

Combine
the groundwater flow equation
and
the advection-dispersion equation
by means of
an equation of state

Solute transport equation

Partial differential equation (PDE):

$$R_d \frac{\partial C}{\partial t} = \frac{\partial}{\partial x_i} \left(D_{ij} \frac{\partial C}{\partial x_j} \right) - \frac{\partial}{\partial x_i} (C V_i) + \frac{(C - C^*) W}{n_e} - R_d \lambda C$$

change in concentration dispersion diffusion advection source/sink decay

D_{ij} =hydrodynamic dispersion [$L^2 T^{-1}$]

R_d =retardation factor [-]

λ =decay-term [T^{-1}]

Solute transport equation: column test (I):

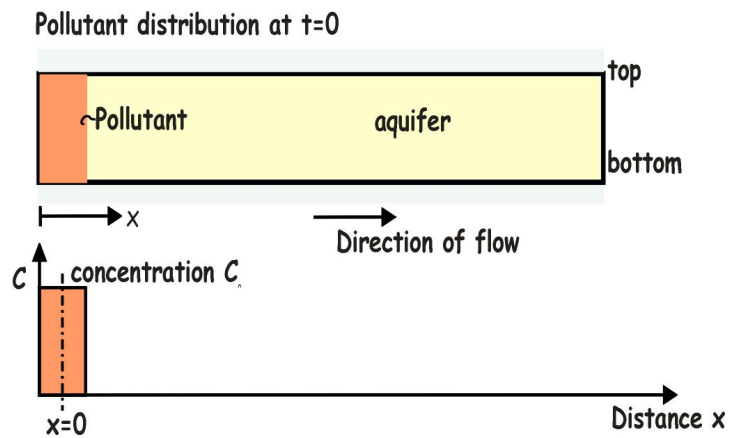

Solute transport equation: column test (II):

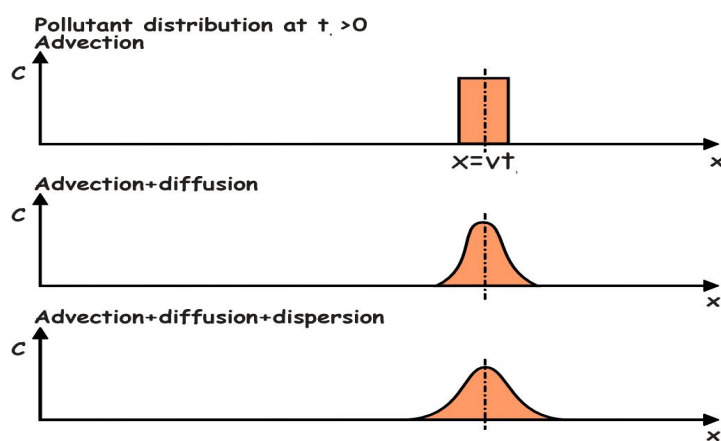

Solute transport equation: column test (III):

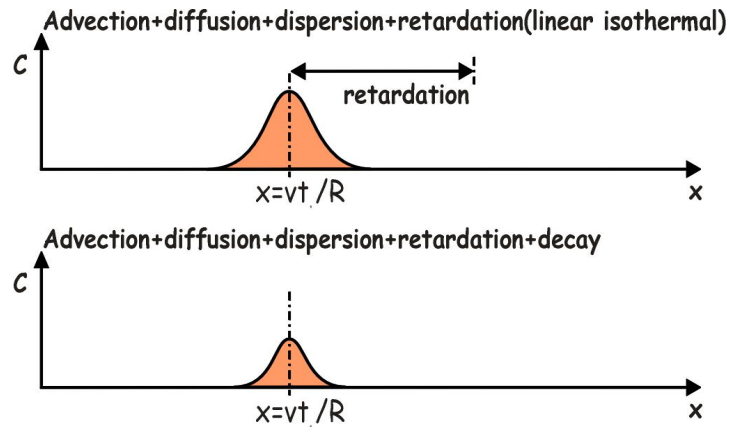

Hydrodynamic dispersion

$$\text{hydrodynamic dispersion} = \text{mechanical dispersion} + \text{diffusion}$$

mechanical dispersion:

tensor
velocity dependant

diffusion:

molecular process
solute spread due to concentration differences

Mechanical dispersion

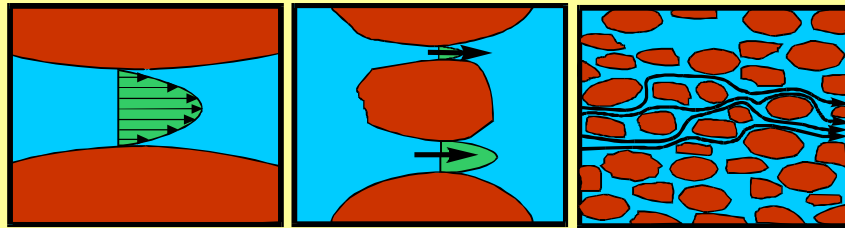

Differences in velocity in the pore

Differences in velocity due to variation in pore-dimension

Differences in velocity due to variation in velocity direction

Scale-dependency longitudinal dispersivity

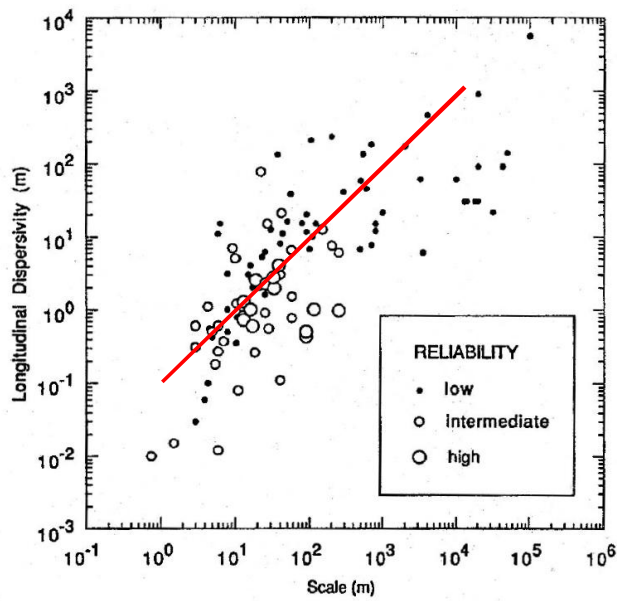

Solute transport equation: diffusion (I)

diffusion is a slow process: diffusion equation

only 1D-diffusion means: $R_d=1$, $V_f=0$, $\lambda=0$ and $W=0$

$$\frac{\partial C}{\partial t} = D \frac{\partial^2 C}{\partial z^2}$$

similarity with non-steady state groundwater flow equation

$$S \frac{\partial \phi}{\partial t} = T \frac{\partial^2 \phi}{\partial x^2} + N \quad \frac{T\Delta t}{S\Delta x^2} < 0.5$$

$$\phi_i^{t+\Delta t} = \phi_i^t + \frac{N\Delta t}{S} + \frac{T\Delta t}{S\Delta x^2} (\phi_{i+1}^t - 2\phi_i^t + \phi_{i-1}^t)$$

$$C_i^{t+\Delta t} = C_i^t + \frac{D\Delta t}{\Delta z^2} (C_{i+1}^t - 2C_i^t + C_{i-1}^t) \quad \frac{D\Delta t}{\Delta z^2} < 0.5$$

Solute transport equation: diffusion (II)

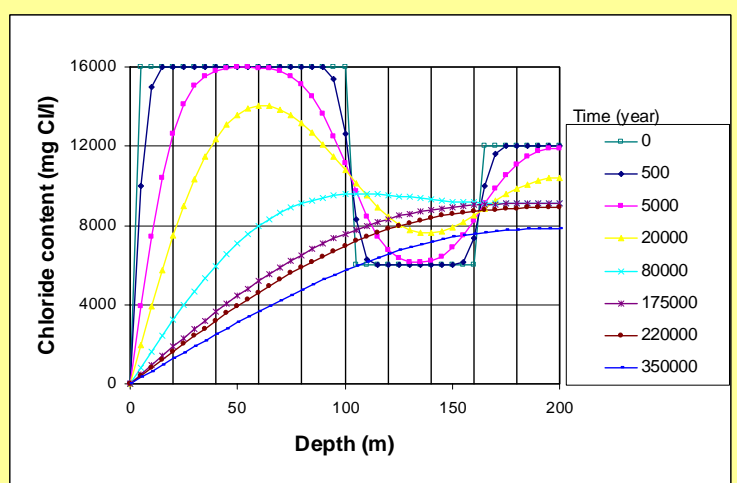
diffusion is a slow process: diffusion equation $\frac{\partial C}{\partial t} = D \frac{\partial^2 C}{\partial z^2}$ 

Solute transport equation: diffusion (III)

Animation as a function of 350.000 years

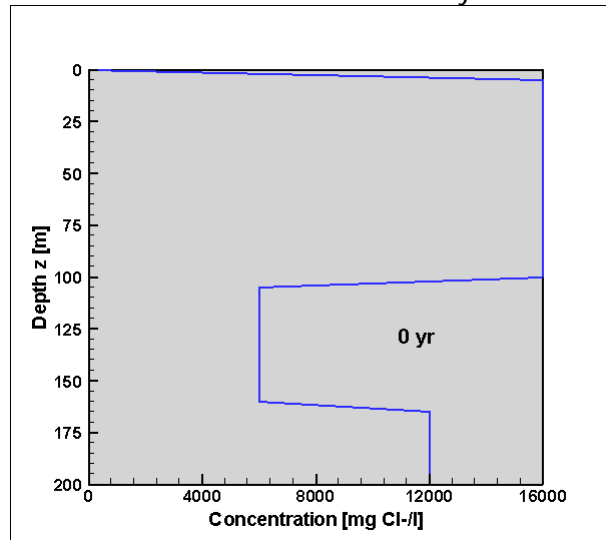

Groundwater flow equation (MODFLOW, 1988)

Darcy

$$q_x = -\frac{\kappa_x \rho_f g}{\mu} \frac{\partial \phi_f}{\partial x}; \quad q_y = -\frac{\kappa_y \rho_f g}{\mu} \frac{\partial \phi_f}{\partial y}; \quad q_z = -\frac{\kappa_z \rho_f g}{\mu} \left(\frac{\partial \phi_f}{\partial z} + \frac{\rho - \rho_f}{\rho_f} \right)$$

Continuity

$$-\left[\frac{\partial \rho q_x}{\partial x} + \frac{\partial \rho q_y}{\partial y} + \frac{\partial \rho q_z}{\partial z} \right] = \frac{\partial n \rho}{\partial t} + W$$

Freshwater head

$$\phi_f = \frac{p}{\rho_f g} + z$$

↑
buoyancy
term

Advection-dispersion equation (MOC3D, 1996)

$$\frac{\partial C}{\partial t} = \frac{1}{nR_f} \frac{\partial}{\partial x_i} \left(nD_{ij} \frac{\partial C}{\partial x_j} \right) - \frac{V_i}{R_f} \frac{\partial C}{\partial x_i} + \frac{\Sigma[W(C' - C)]}{nR_f} - \lambda C$$

Equation of state: relation density & concentration

$$\rho_{i,j,k} = \rho_f (1 + \beta C_{i,j,k})$$

MOCDENS3D is based on MODFLOW

a modular 3D finite-difference ground-water flow model

(M.G. McDonald & A.W. Harbaugh, from 1983 on)

- USGS, 'public domain'
- non steady state
- heterogeneous porous medium
- anisotropy
- coupled to reactive solute transport
 - MOC3 (Konikow *et al*, 1996)
 - MT3D, MT3DMS (Zheng, 1990)
 - RT3D
 - PHT3D (Prommer, 2004)
- easy to use due to numerous Graphical User Interfaces (GUI 's)
 - PMWIN, GMS, Visual Modflow, Argus One, Groundwater Vistas, etc.

Nomenclature MODFLOW element $[i,j,k]$

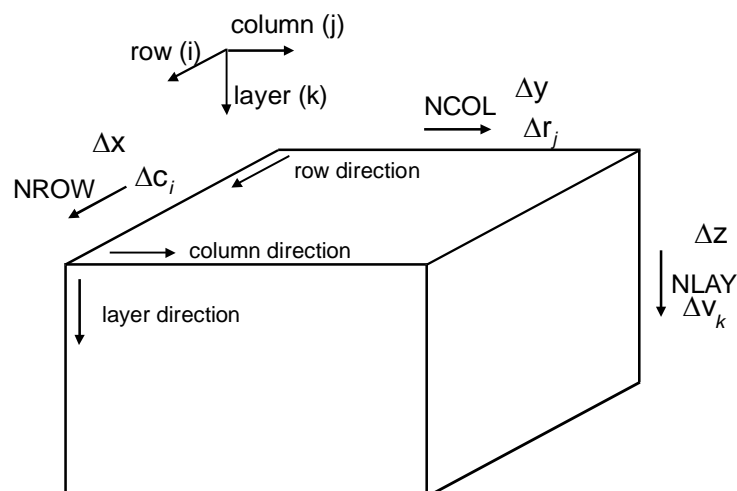

MODFLOW: start with water balance of one element [i,j,k]

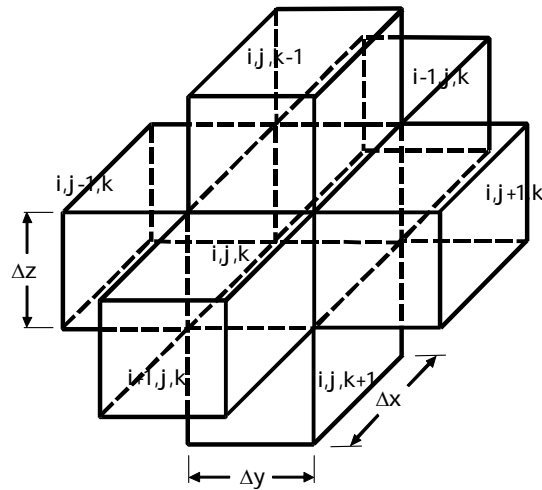

Continuity equation (I)

In - Out = Storage

$$\frac{\partial}{\partial x} \left(k_{xx} \frac{\partial \phi}{\partial x} \right) + \frac{\partial}{\partial y} \left(k_{yy} \frac{\partial \phi}{\partial y} \right) + \frac{\partial}{\partial z} \left(k_{zz} \frac{\partial \phi}{\partial z} \right) - W = S_s \frac{\partial \phi}{\partial t}$$

$$\sum Q_i = S_s \frac{\Delta \phi}{\Delta t} \Delta V$$

Continuity equation (II)

$$\sum Q_i = S_s \frac{\Delta\phi}{\Delta t} \Delta V$$

In = positive

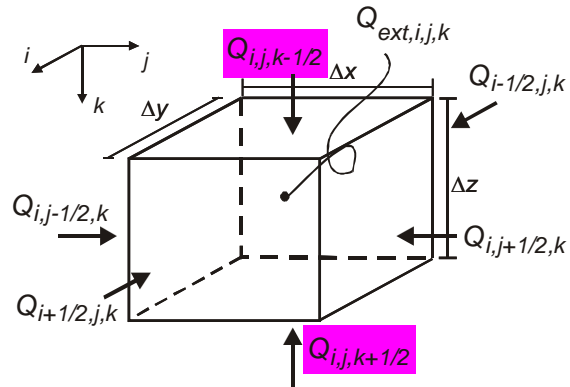

$$Q_{i,j-1/2,k} + Q_{i,j+1/2,k} + Q_{i-1/2,j,k} + Q_{i+1/2,j,k} + Q_{i,j,k-1/2} + Q_{i,j,k+1/2} + Q_{ext,i,j,k}$$

$$= SS_{i,j,k} \frac{\phi_{i,j,k}^t - \phi_{i,j,k}^{t+\Delta t}}{\Delta t} \Delta V$$

Flow equation (Darcy's Law)

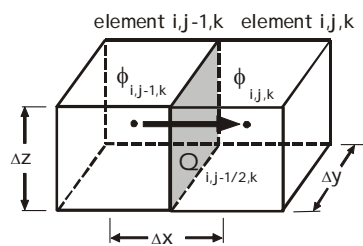

$$Q = \text{surface} * q = \text{surface} * k \frac{\partial\phi}{\partial x}$$

$$Q_{i,j-1/2,k} = k_{i,j-1/2,k} \Delta y \Delta z \frac{\phi_{i,j-1,k} - \phi_{i,j,k}}{\Delta x}$$

$$Q_{i,j-1/2,k} = CR_{i,j-1/2,k} (\phi_{i,j-1,k} - \phi_{i,j,k})$$

$$\text{where } CR_{i,j-1/2,k} = \frac{k_{i,j-1/2,k} \Delta y \Delta z}{\Delta x} \text{ is the conductance [L}^2\text{/T]}$$

Density dependent vertical flow equation

$$q_z = -\frac{\kappa_z \rho_f g}{\mu} \left(\frac{\partial \phi_f}{\partial z} + \frac{\rho - \rho_f}{\rho_f} \right)$$

$$q_z = -k_z \left(\frac{\partial \phi_f}{\partial z} + \frac{\rho - \rho_f}{\rho_f} \right)$$

$$Q_z = \text{surface} * q_z$$

$$= \text{surface} * k_z \left(\frac{\partial \phi_f}{\partial z} + \frac{\rho - \rho_f}{\rho_f} \right)$$

$$Q_{i,j,k-1/2} = k_{i,j,k-1/2} \Delta x \Delta y \left(\frac{\phi_{f,i,j,k-1} - \phi_{f,i,j,k}}{\Delta z} + BUOY_{i,j,k-1/2} \right)$$

$$Q_{i,j,k-1/2} = CV_{i,j,k-1/2} (\phi_{f,i,j,k-1} - \phi_{f,i,j,k} + BUOY_{i,j,k-1/2} \Delta z)$$

$$\text{where } BUOY_{i,j,k-1/2} = \left(\frac{(\rho_{i,j,k-1/2} + \rho_{i,j,k}) / 2 - \rho_f}{\rho_f} \right) = \text{buoyancy term [-]}$$

$$\text{where } CV_{i,j,k-1/2} = \frac{k_{i,j,k-1/2} \Delta x \Delta y}{\Delta z} = \text{conductance [L}^2/\text{T]}$$

Density dependent groundwater flow equation

$$Q_{i,j-1/2,k} = CR_{i,j-1/2,k} (\phi_{f,i,j-1,k} - \phi_{f,i,j,k})$$

$$Q_{i,j+1/2,k} = CR_{i,j+1/2,k} (\phi_{f,i,j+1,k} - \phi_{f,i,j,k})$$

$$Q_{i-1/2,j,k} = CC_{i-1/2,j,k} (\phi_{f,i-1,j,k} - \phi_{f,i,j,k})$$

$$Q_{i+1/2,j,k} = CC_{i+1/2,j,k} (\phi_{f,i+1,j,k} - \phi_{f,i,j,k})$$

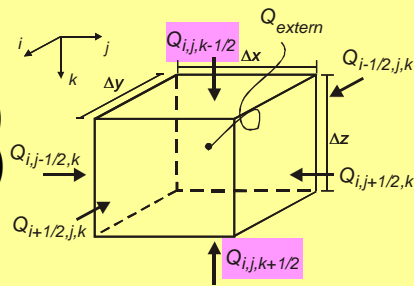

$$Q_{i,j,k-1/2} = CV_{i,j,k-1/2} (\phi_{f,i,j,k-1} - \phi_{f,i,j,k} + BUOY_{i,j,k-1/2} \Delta v_{k-1/2})$$

$$Q_{i,j,k+1/2} = CV_{i,j,k+1/2} (\phi_{f,i,j,k+1} - \phi_{f,i,j,k} - BUOY_{i,j,k+1/2} \Delta v_{k+1/2})$$

$$Q_{i,j-1/2,k} + Q_{i,j+1/2,k} + Q_{i-1/2,j,k} + Q_{i+1/2,j,k} + Q_{i,j,k-1/2} + Q_{i,j,k+1/2} + Q_{ext,i,j,k}$$

$$= SS_{i,j,k} \frac{\phi_{f,i,j,k}^t - \phi_{f,i,j,k}^{t+\Delta t}}{\Delta t} \Delta V$$

The term $Q_{ext,i,j,k}$

Takes into account all external sources

Rewriting the term:

$$Q_{ext,i,j,k} = P_{i,j,k} \phi_{i,j,k}^{t+\Delta t} + Q'_{i,j,k}$$

The variable density groundwater flow equation

$$Q_{i,j-1/2,k} + Q_{i,j+1/2,k} + Q_{i-1/2,j,k} + Q_{i+1/2,j,k} + Q_{i,j,k-1/2} + Q_{i,j,k+1/2} + Q_{ext,i,j,k} \\ = SS_{i,j,k} \frac{\phi_{f,i,j,k}^t - \phi_{f,i,j,k}^{t+\Delta t}}{\Delta t} \Delta V$$

and:

$$Q_{ext,i,j,k} = P_{i,j,k} \phi_{f,i,j,k}^{t+\Delta t} + Q'_{i,j,k}$$

gives:

$$CV_{i,j,k-1/2} \phi_{f,i,j,k-1}^{t+\Delta t} + CC_{i-1/2,j,k} \phi_{f,i-1,j,k}^{t+\Delta t} + CR_{i,j-1/2,k} \phi_{f,i,j-1,k}^{t+\Delta t} \\ + (-CV_{i,j,k-1/2} - CC_{i-1/2,j,k} - CR_{i,j-1/2,k} - CR_{i,j+1/2,k} - CC_{i+1/2,j,k} - CV_{i,j,k+1/2} + HCOF_{i,j,k}) \phi_{f,i,j,k}^{t+\Delta t} \\ + CR_{i,j+1/2,k} \phi_{f,i,j+1,k}^{t+\Delta t} + CC_{i+1/2,j,k} \phi_{f,i+1,j,k}^{t+\Delta t} + CV_{i,j,k+1/2} \phi_{f,i,j,k+1}^{t+\Delta t} = RHS_{i,j,k}$$

with:

$$HCOF_{i,j,k} = P_{i,j,k} - SC1_{i,j,k} / (\Delta t)$$

$$RHS_{i,j,k} = -Q'_{i,j,k} - SC1_{i,j,k} \phi_{f,i,j,k}^t / (\Delta t)$$

$$-CV_{i,j,k-1/2} BUOY_{i,j,k-1/2} \Delta v_{k-1/2} + CV_{i,j,k+1/2} BUOY_{i,j,k+1/2} \Delta v_{k+1/2}$$

$$SC1_{i,j,k} = SS_{i,j,k} \Delta V$$

Equation of state

$$BUOY_{i,j,k-1/2} = \left(\frac{(\rho_{i,j,k-1/2} + \rho_{i,j,k})/2 - \rho_f}{\rho_f} \right)$$

$$\rho_{i,j,k} = \rho_f \left(1 + \frac{\rho_s - \rho_f}{\rho_f} \frac{C_{i,j,k}}{C_s} \right)$$

or

$$\rho_{i,j,k} = \rho_f (1 + \beta C_{i,j,k})$$

Method of Characteristics (MOC)

Solve the advection-dispersion equation (ADE)
with the Method of Characteristics

$$\frac{\partial C}{\partial t} = \frac{\partial}{\partial x_i} \left(D_{ij} \frac{\partial C}{\partial x_j} \right) - \frac{\partial}{\partial x_i} (C V_i) + \frac{(C - C)W}{n_e}$$

Lagrangian approach:

Splitting up the advection part and the dispersion/source part:

- advection by means of a particle tracking technique
- dispersion/source by means of the finite difference method

Advantage of the MOC approach by splitting up the advection-dispersion equation

It is difficult to solve the whole advection-dispersion equation in one step, because the so-called Peclet-number is high in most groundwater flow/solute transport problems.

The Peclet number stands for the ratio between advection and dispersion

Procedure of MOC: advective transport by particle tracking

- Place a number of particles in each element
- Determine the effective velocity of each particle by (bi)linear interpolation of the velocity field which is derived from MODFLOW
- Move particles during one solute time step Δt_{solute}
- Average values of all particles in an element to one node value
- Calculate the change in concentration in all nodes due to advective transport
- Add this result to dispersive/source changes of solute transport

Steps in MOC-procedure

1. Determine concentration gradients at old timestep $k-1$
2. Move particles to model advective transport
3. Concentration of particles to concentration in element node
4. Determine concentration gradients on new timestep k^*
5. Determine concentration in element node after advective, dispersive/source transport on timestep k

Konikow and Bredehoeft, 1978

Causes of errors in MOC-procedure

1. Concentration gradients
2. Average from particles to node element, and visa versa
3. Concentration of sources/sinks to entire element
4. Empty elements
5. No-flow boundary: reflection in boundary

Reflection in boundary

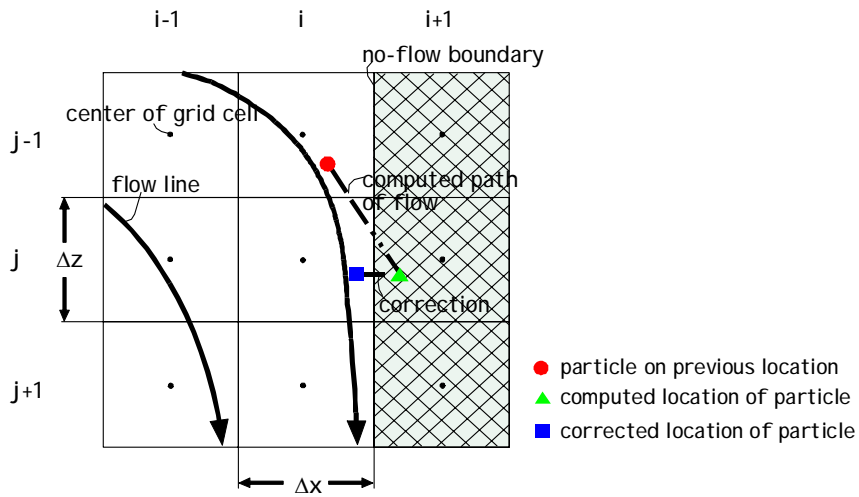

Stability criteria (III)

3. Courant criterium

- * Node element
- Particle
- Velocity direction
- Movement particles

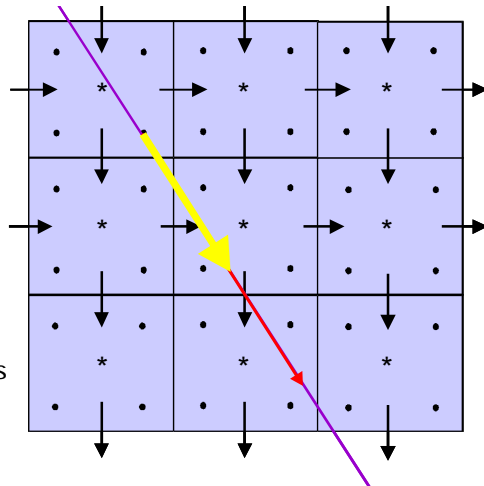

$$0 < \xi \leq 1$$

$$\Delta t_s \leq \frac{\xi \Delta x}{V_{x,\max}}$$

$$\Delta t_s \leq \frac{\xi \Delta y}{V_{y,\max}}$$

$$\Delta t_s \leq \frac{\xi \Delta z}{V_{z,\max}}$$

Courant criterion: places where timestep is smaller than 40 days

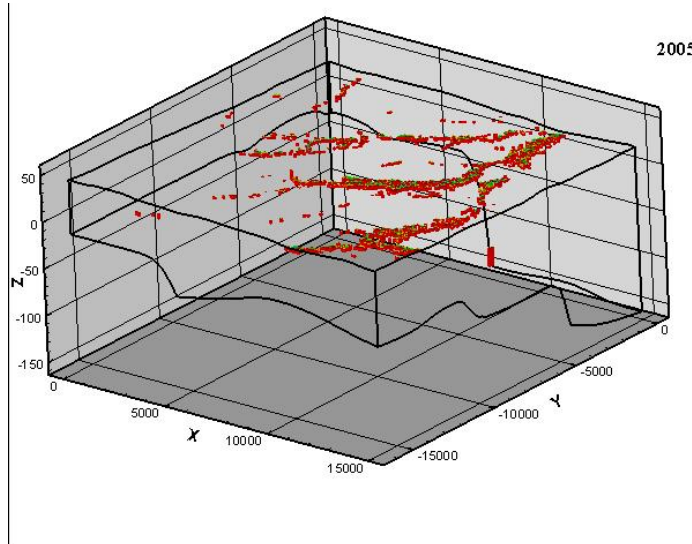

Numerical dispersion and oscillation

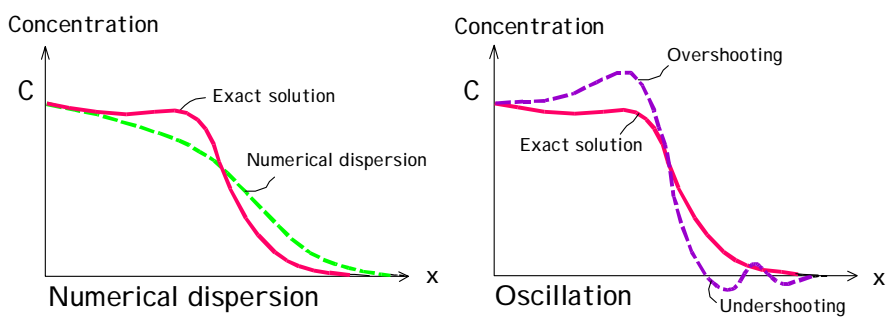

$$\frac{\partial C}{\partial t} = D \frac{\partial^2 C}{\partial z^2} \quad C_i^{t+\Delta t} = C_i^t + \frac{D\Delta t}{\Delta z^2} (C_{i+1}^t - 2C_i^t + C_{i-1}^t) \quad \frac{D\Delta t}{\Delta z^2} < 0.5$$

Numerical dispersion problem (I)

To solve the advection-dispersion equation, standard finite difference and element techniques should consider the following spatial discretisation criterion:

$$\text{Peclet number } Pe \leq 2 \text{ to } 4$$

$$\text{where: } Pe = \frac{V\Delta x}{D_h}$$

- V = effective velocity [L/T]
- Δx = dimension grid cell [L]
- D_h = hydrodynamic dispersion [L²/T]

Numerical dispersion problem (II)

For advection dominant groundwater flow, the Peclet number can be rewritten as:

$$\Delta x \leq 2\alpha_L \text{ to } 4\alpha_L$$

where α_L = longitudinal dispersivity [L]

What does that mean?

If α_L is small, then Δx should be small too!!

Numerical dispersion problem (III)

Now follows an transient salt water intrusion case to demonstrate why in many coastal aquifers the longitudinal dispersivity α_L [L] should be small

Effect of α_L on the salinisation of the aquifer (I)

Position profile through Amsterdam Waterworks, Rijnland polders and Haarlemmermeer polder

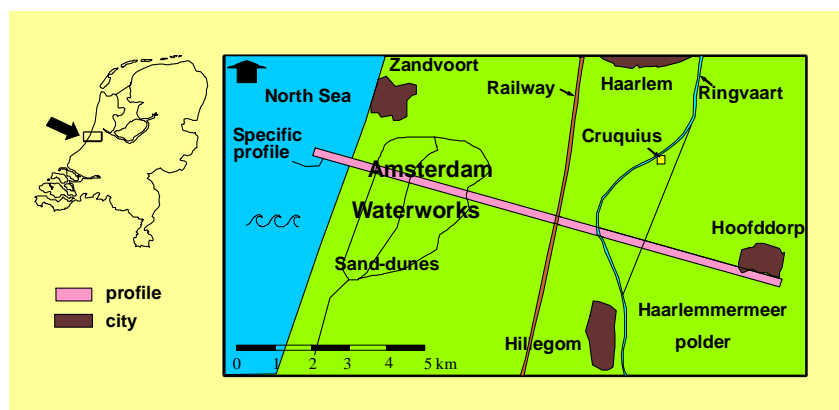

Effect of α_L on the salinisation of the aquifer (II)

Grondwater extractions out of the middle aquifer in the sand-dune area of Amsterdam Waterworks

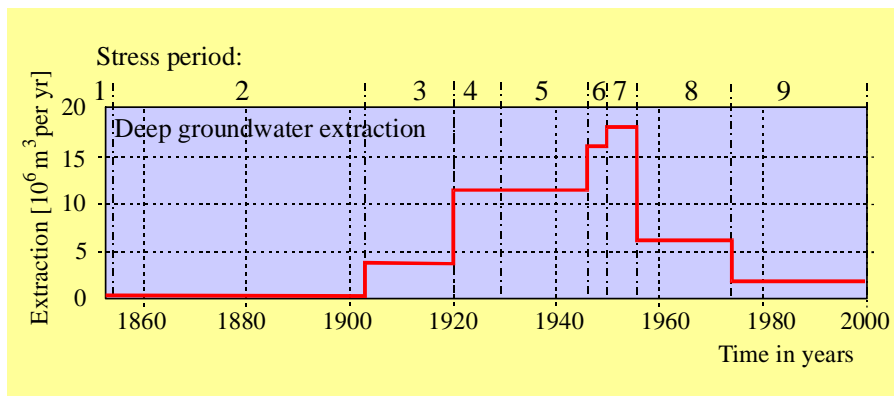

Effect of α_L on the salinisation of the aquifer (III)

$\alpha_L = 1 \text{ m}$

Initial situation: 154 years ago

Profile Amsterdam Waterworks-Haarlemmemeerpolder

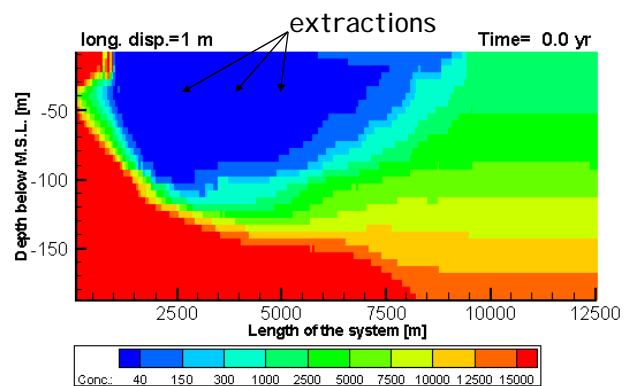

Effect of α_L on the salinisation of the aquifer (IV)

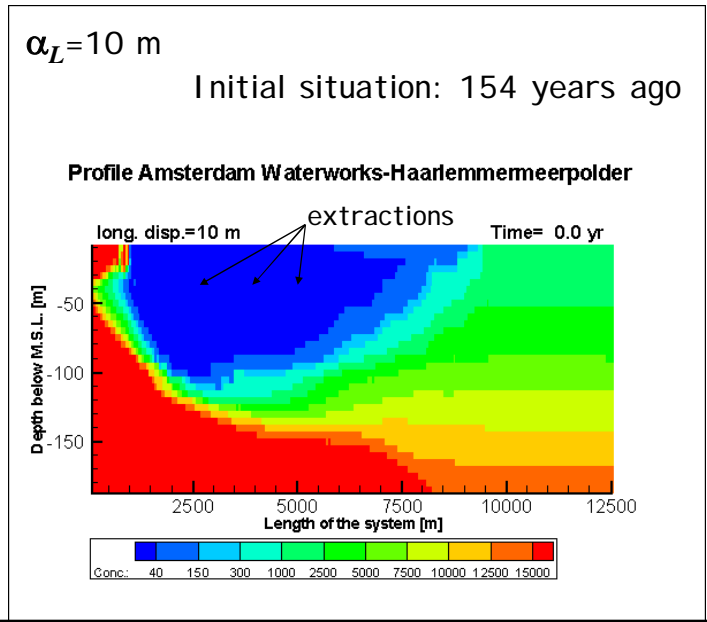

MODFLOW

Boundary conditions in MODFLOW (I)

Example of a system with three types of boundary conditions

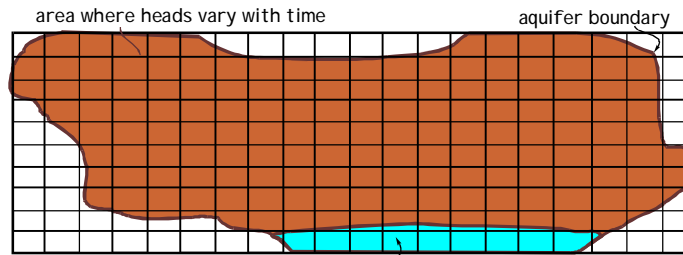

Numeric model

0	1	1	1	1	1	0	0	0	0	0	0	0	1	1	1	1	1	0	0	
1	1	1	1	1	1	1	1	1	1	1	1	1	1	1	1	1	1	1	1	0
1	1	1	1	1	1	1	1	1	1	1	1	1	1	1	1	1	1	1	0	
0	1	1	1	1	1	1	1	1	1	1	1	1	1	1	1	1	1	1	0	
0	0	1	1	1	1	1	1	1	1	1	1	1	1	1	1	1	1	1	0	
0	0	1	1	1	1	1	1	1	1	1	1	1	1	1	1	1	1	1	1	
0	0	1	1	1	1	1	1	1	1	1	1	1	1	1	1	1	1	1	1	
0	0	1	1	1	1	1	1	1	1	1	1	1	1	1	1	1	1	1	0	
0	0	0	0	0	0	1	1	1	1	1	1	1	1	1	1	1	1	1	0	
0	0	0	0	0	0	0	-1	-1	-1	-1	-1	-1	-1	-1	-1	-1	0	0	0	

Boundary conditions in MODFLOW (II)

- For a constant head condition: IBOUND<0
- For a no flow condition: IBOUND=0
- For a variable head: IBOUND>0

Packages in MODFLOW

1. Well package
2. River package
3. Recharge package
4. Drain package
5. Evaporation package
6. General head package

1. Well package

$$Q_{well} = Q_{i,j,k}$$

Example: an extraction of 10 m³ per day should be inserted in an element as:

$$Q_{ext,i,j,k} = P_{i,j,k} \phi_{i,j,k}^{t+\Delta t} + Q'_{i,j,k}$$

$$Q_{ext,i,j,k} = -10 \quad (\text{in} = \text{positive})$$

$$Q'_{i,j,k} = -10$$

2. River package (I)

river loses water

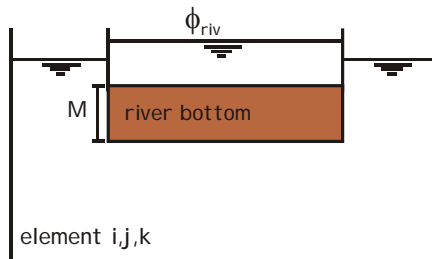

river gains water

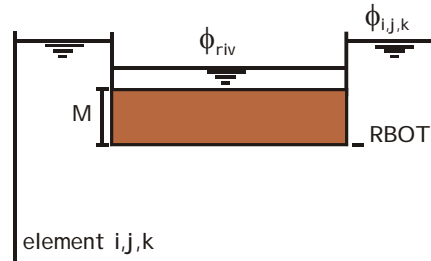

$$Q_{riv} = KLW \left(\frac{\phi_{riv} - \phi_{i,j,k}}{M} \right)$$

$$Q_{riv} = \frac{KLW}{M} (\phi_{riv} - \phi_{i,j,k}) \Leftrightarrow Q_{riv} = C_{riv} (\phi_{riv} - \phi_{i,j,k})$$

2. River package (II)

$$Q_{riv} = C_{riv} (\phi_{riv} - \phi_{i,j,k})$$

Example: the river conductance C_{riv} is 20 m²/day and the river level=3 m, than this package should be inserted in an element as:

$$Q_{ext,i,j,k} = P_{i,j,k} \phi_{i,j,k}^{t+\Delta t} + Q'_{i,j,k}$$

$$Q_{ext,i,j,k} = 20(3 - \phi_{i,j,k})$$

$$Q'_{i,j,k} = 60 \quad \text{and} \quad P_{i,j,k} = -20$$

2. River package (III)

Determine the conductance of the river in one element:

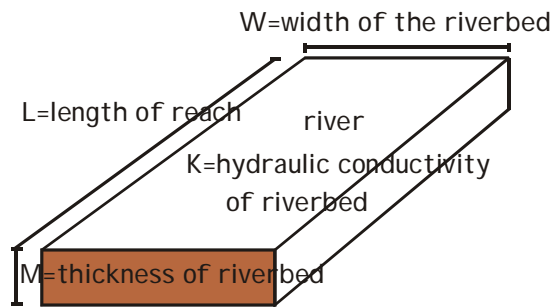

where $C_{riv} = \frac{KLW}{M}$ is the conductance [L^2/T] of the river

2. River package (IV)

Leakage to the groundwater system

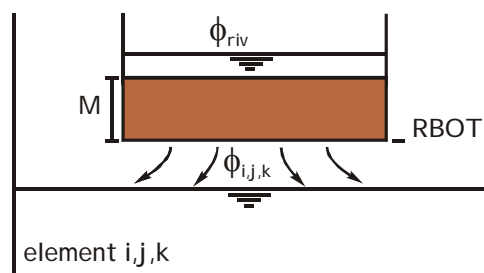

Special case:

if $\phi_{i,j,k} < RBOT$, then $Q_{riv} = C_{riv}(\phi_{riv} - RBOT)$

2. River package (V)

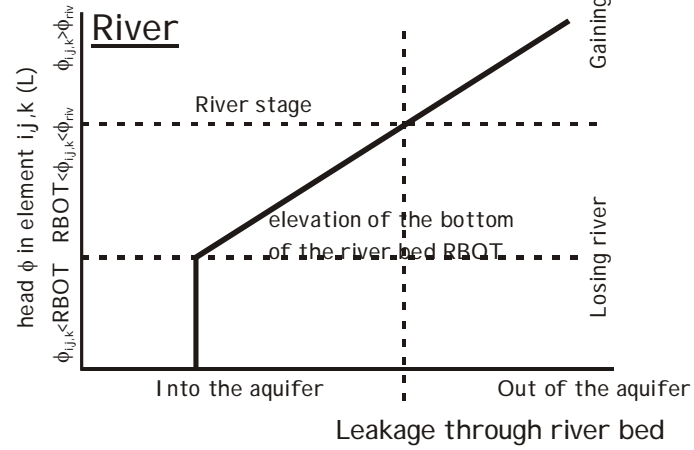

3. Recharge package

$$Q_{rec} = I\Delta x\Delta y$$

4. Drain package

$$Q_{dm} = C_{dm} (\phi_{i,j,k} - d)$$

Special case: →

if $\phi_{i,j,k} < d$ than $Q_{dm} = 0$

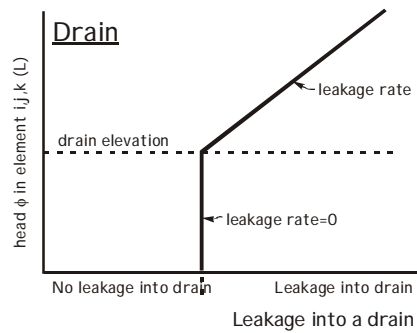
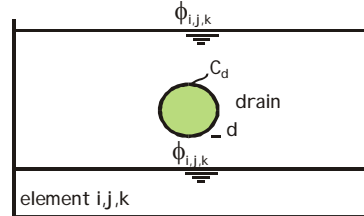

5. Evapotranspiration package

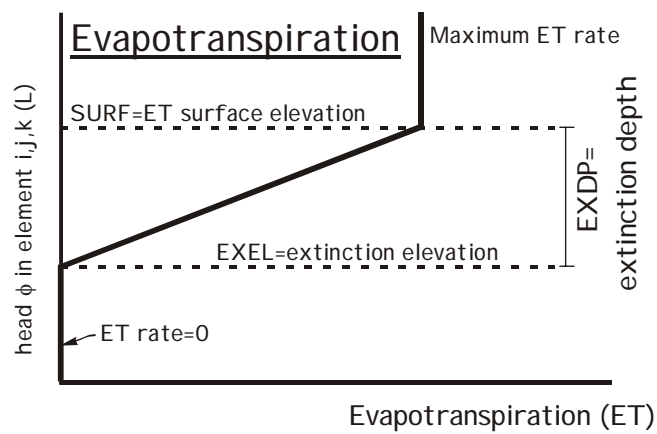

6. General head boundary package

$$Q_{ghb} = C_{ghb} (\phi_{ghb} - \phi_{i,j,k})$$

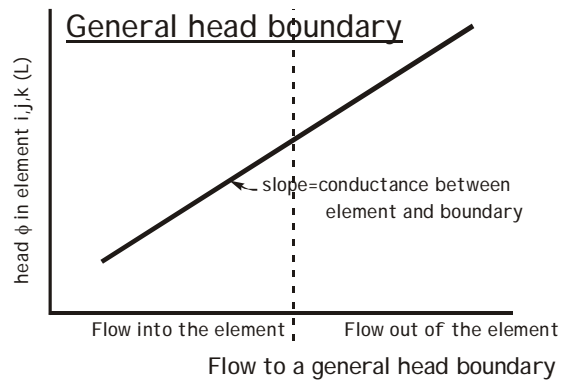
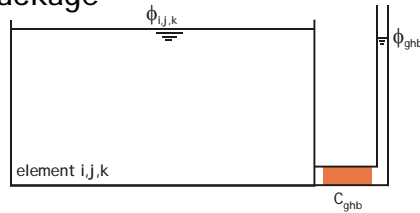

- 1 (name).bas-file
- 2 (name).bcf-file
- 3 (name).moc-file
- 4 (name).wel-file
- 5 (name).riv-file
- 6 (name).drn-file
- 7 (name).ghb-file
- 8 (name).sip-file
- 9 densin.dat-file
- 10 (name).nam-files

Time indication MODFLOW

I TMUNI =1: seconde
 I TMUNI =2: minute
 I TMUNI =3: hour
 I TMUNI =4: day
 I TMUNI =5: year

Flow time step and solute time step

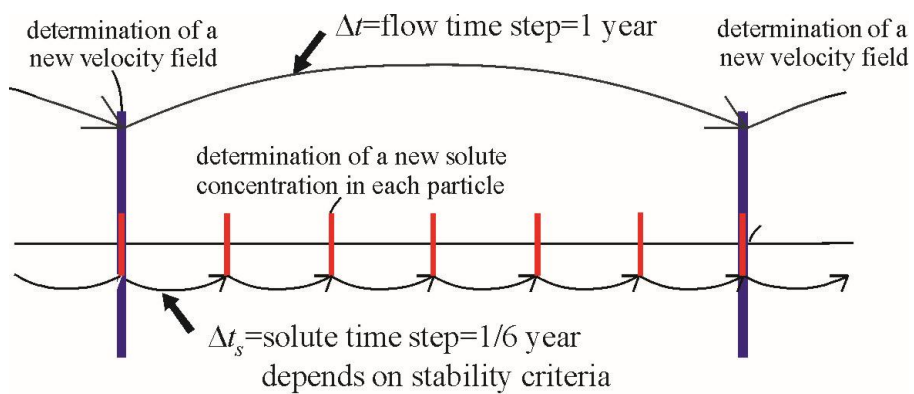

- * velocity field remains constant during 1 year
- * solute concentration changes during each solute time step

