

WANDA

Deltares
Enabling Delta Life



Wanda 4 Gas



Wanda 4 Gas Motivation

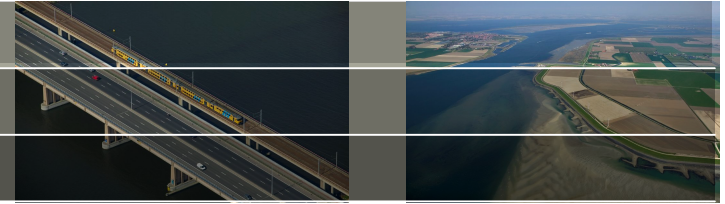

- Transient phenomena in gas systems
 - Abrupt
 - Wave phenomena
 - Non-isothermal processes
 - Convection, expansion, conduction
- Applications
 - Gas wells
 - > Choke valve break out
 - > Blow out
 - Pneumatic systems
 - Air conditioning systems

Wanda 4 Gas Models

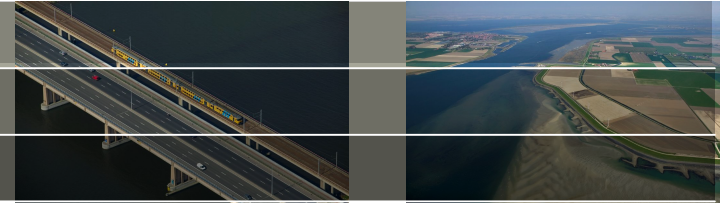

- Pipeline
- Valve
- Compressor
- Reservoir
- Checkvalve
- ...

Wanda 4 Gas Pipeline model

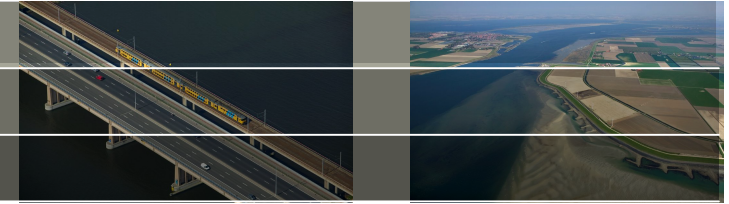

- Conservation of mass

$$\frac{1}{C^2} \left(\frac{\partial P}{\partial t} + V \frac{\partial P}{\partial x} \right) + \rho \frac{\partial V}{\partial x} = \frac{1}{c_p T} \left(\frac{4\tau_w V}{D} + \frac{\phi}{A} \right)$$

- Conservation of momentum

$$\rho \left(\frac{\partial V}{\partial t} + V \frac{\partial V}{\partial x} \right) + \frac{\partial P}{\partial x} = -\frac{4\tau_w}{D} - \rho g \sin \theta$$

- Conservation of energy

$$\rho c_p \left(\frac{\partial T}{\partial t} + V \frac{\partial T}{\partial x} \right) = \left(\frac{\partial P}{\partial t} + V \frac{\partial P}{\partial x} \right) + \frac{4\tau_w V}{D} + \frac{\phi}{A}$$

- Equation of state

$$P = ZR\rho T$$

- Wave speed

$$C = \sqrt{ZkRT}$$

- Wall friction

$$\tau_w = f \frac{\rho}{8} V |V|$$

- Heat conduction

$$\phi = L_T (T_a - T)$$

Wanda 4 Gas Valve model

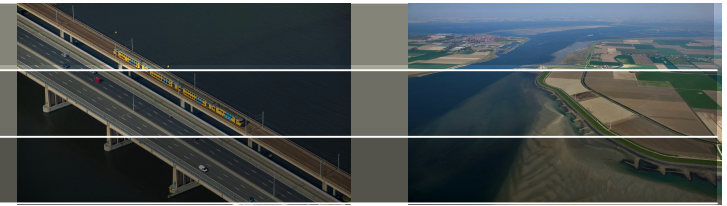

- 8 unknowns $P_1 \quad V_1 \quad \rho_1 \quad T_1 \quad P_2 \quad V_2 \quad \rho_2 \quad T_2$
- Conservation of mass $\rho_1 V_1 - \rho_2 V_2 = 0$
- Conservation of momentum $W (= \rho_1 A_1 V_1) = A_v Y \sqrt{X P_1 \rho_1}$
 - Discharge coefficient $A_v = 7.6 \times 10^{-7} C_v$
 - Pressure ratio $X = (P_1 - P_2) / P_1$
 - Gas expansion fact. $Y = 1 - \frac{X}{3F_k X_T} \quad Y_{\text{critical}} = 1 - \frac{1}{3F_k} \quad F_k = k / k_{\text{air}} = k / 1.4$
- Conservation of energy $\left(c_p T_1 + \frac{V_1^2}{2} \right) - \left(c_p T_2 + \frac{V_2^2}{2} \right) = 0$
- Equation of state $P = Z R \rho T$

Wanda 4 Gas

Validation example: shock tube

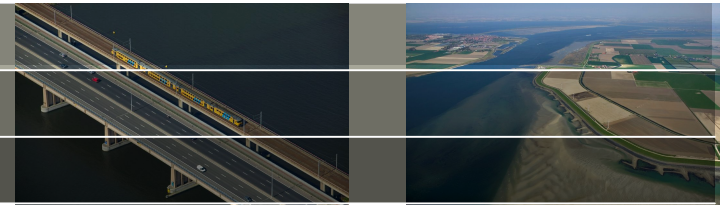

Two tubes with different initial pressures and temperatures are separated by a membrane

Membrane breaks

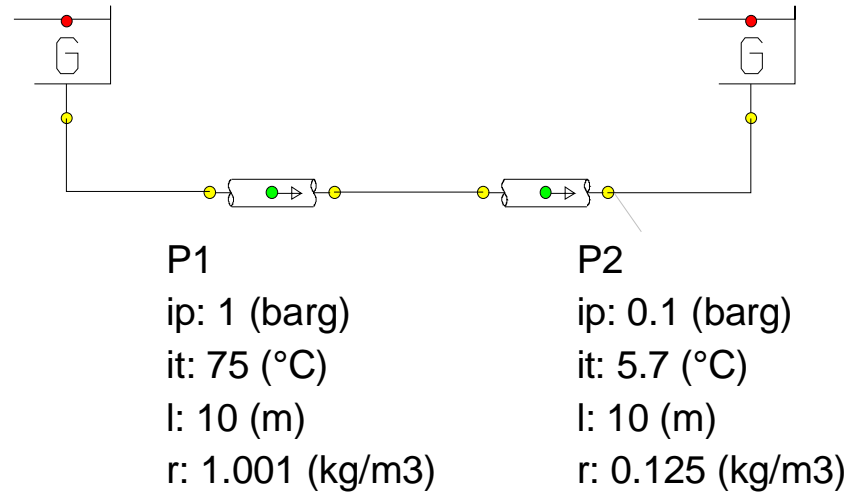

Wanda 4 Gas

Validation example: shock tube

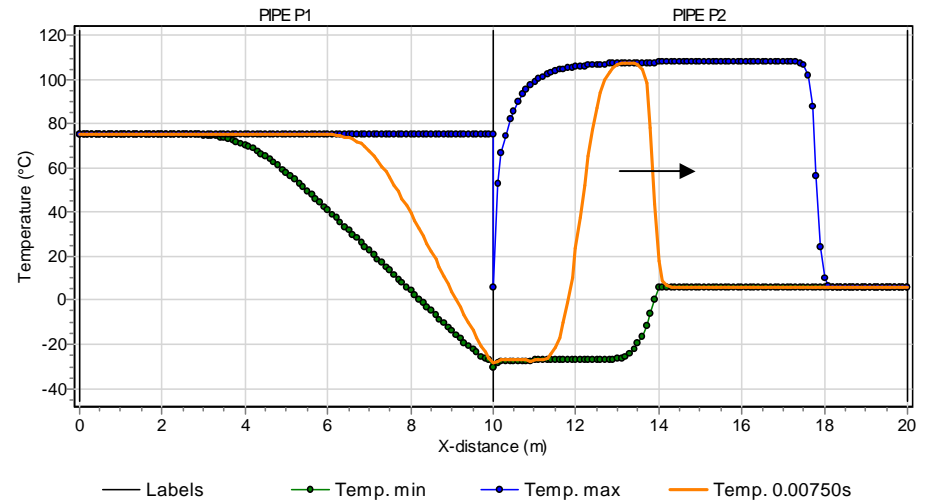
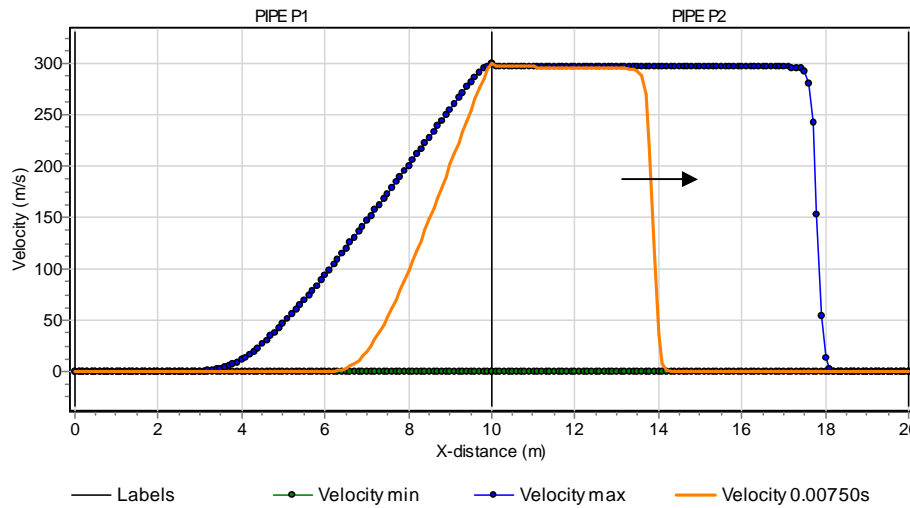
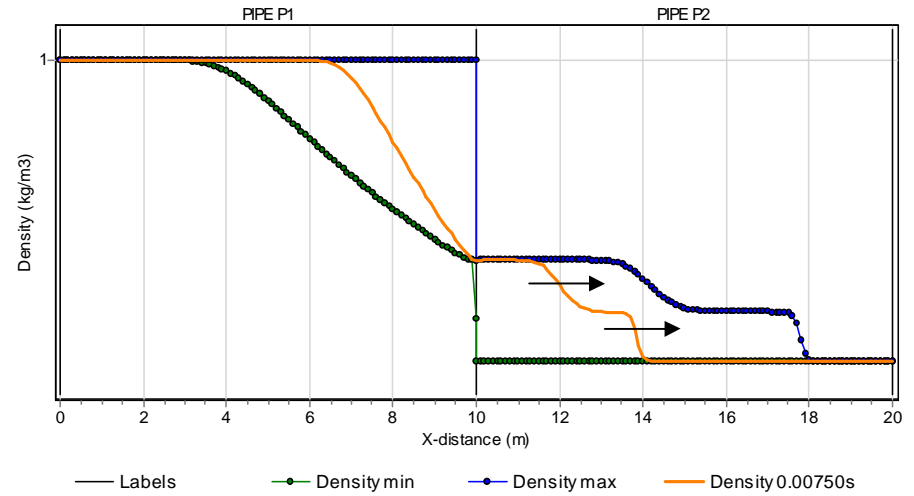
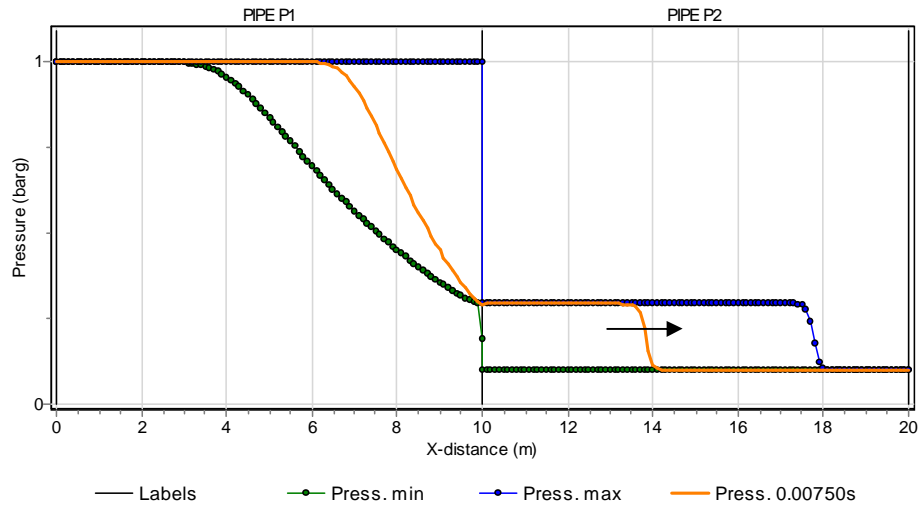
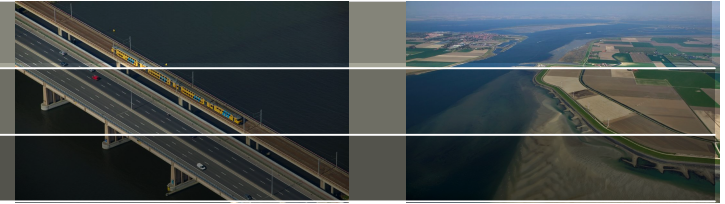

Wanda 4 Gas

Example: free convection

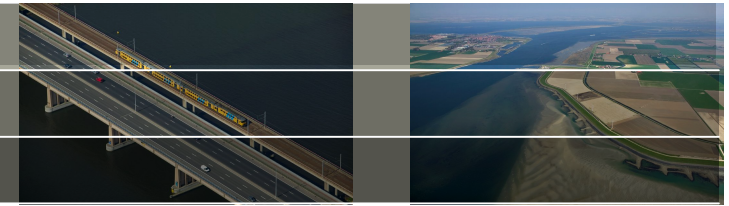

Vertical loop of 4 tubes (side view)

Left tube is heated, right tube is cooled

First a expansion-compression flow sets in

Afterwards a circular convection develops

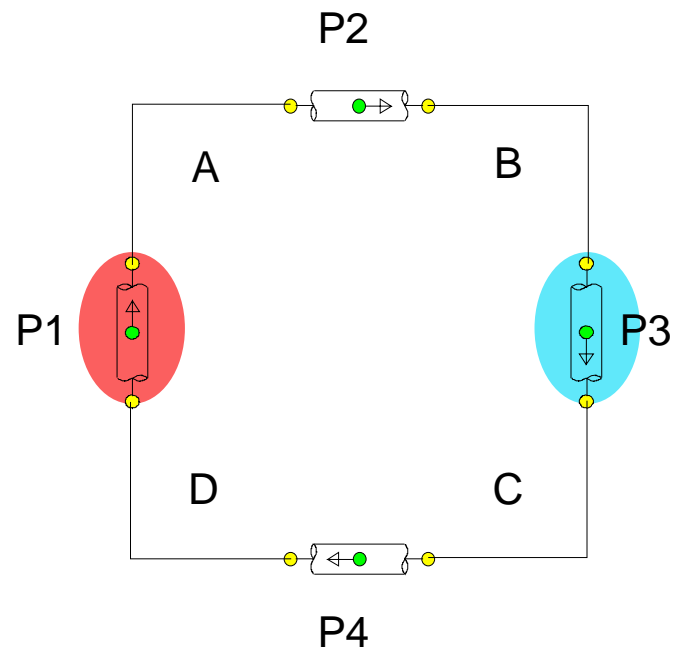

Wanda 4 Gas

Example: free convection

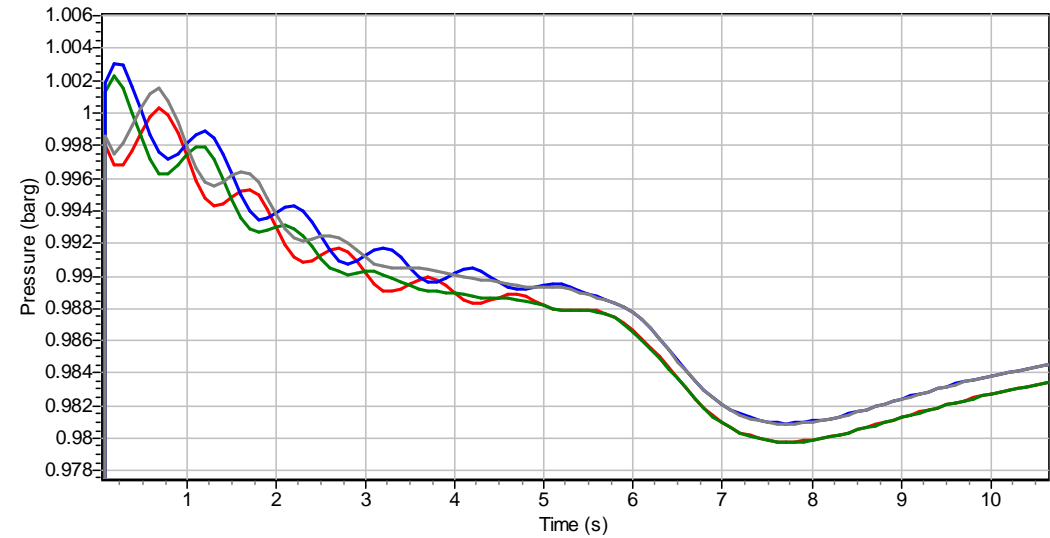
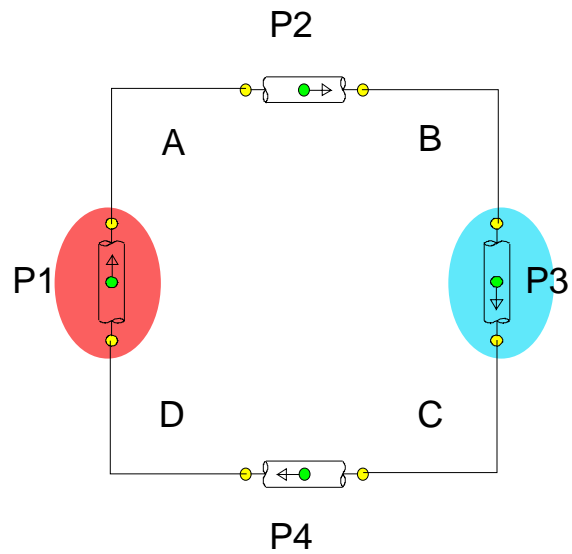
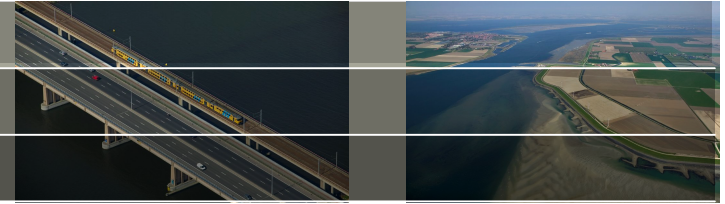

— Pressure NODE A — Pressure NODE B — Pressure NODE C — Pressure NODE D

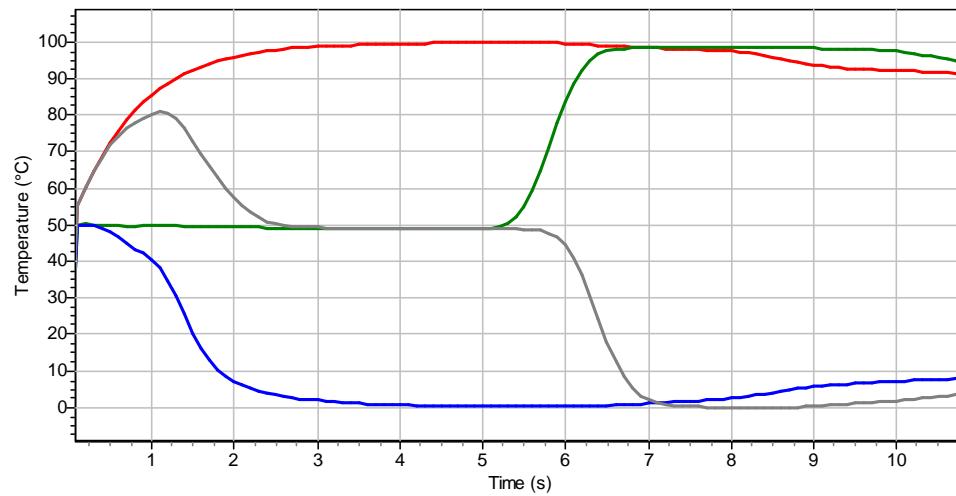

— Temperature NODE A — Temperature NODE B — Temperature NODE C — Temperature NODE D

Wanda 4 Gas

Example: free convection

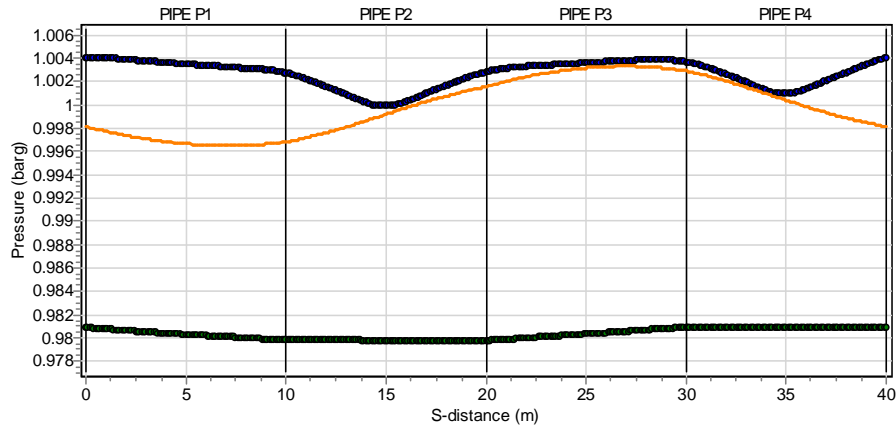
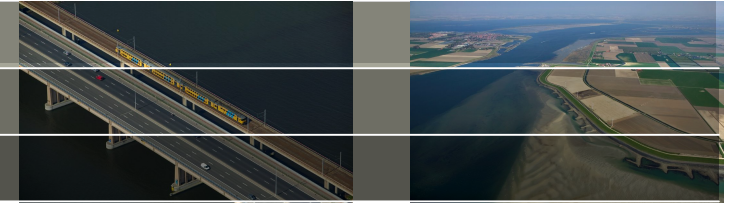

— Labels ● Pressure min ● Pressure max
— Pressure 0.30000s

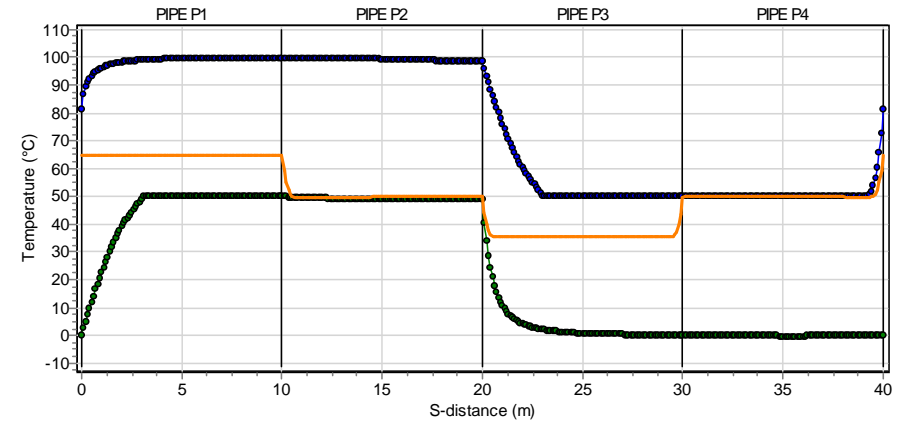

— Labels ● Temperature min ● Temperature max
— Temperature 0.30000s

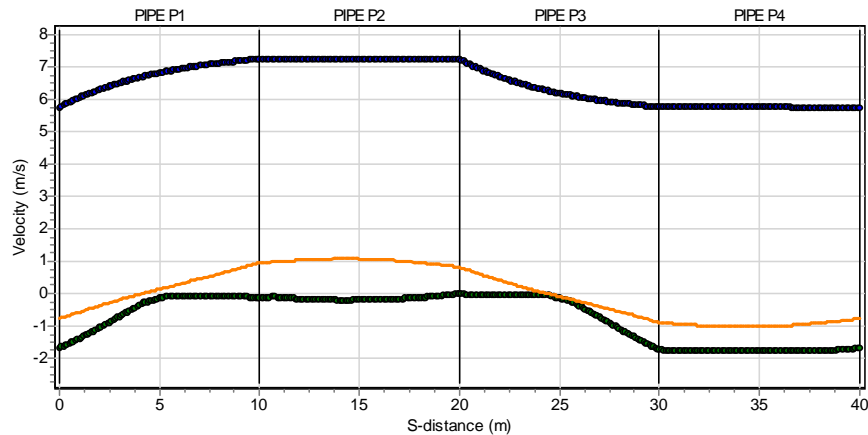

— Labels ● Velocity min ● Velocity max — Velocity 0.30000s

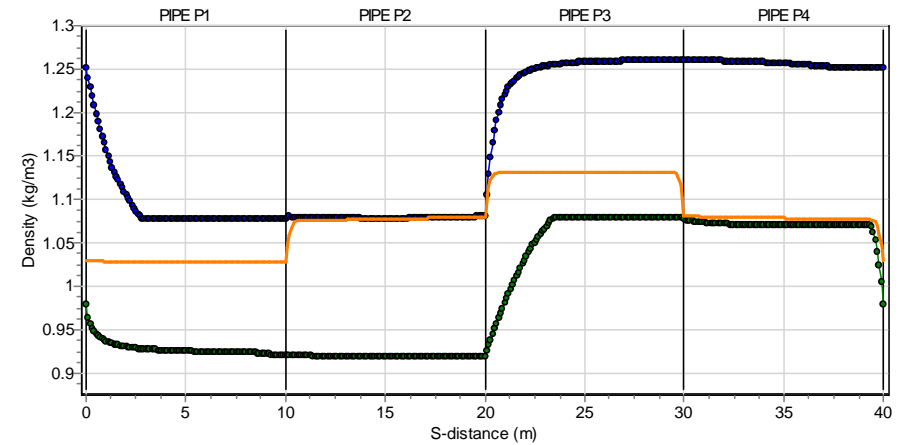

— Labels ● Density min ● Density max — Density 0.30000s

Expansion en compression after 0.3 s

Wanda 4 Gas

Example: free convection

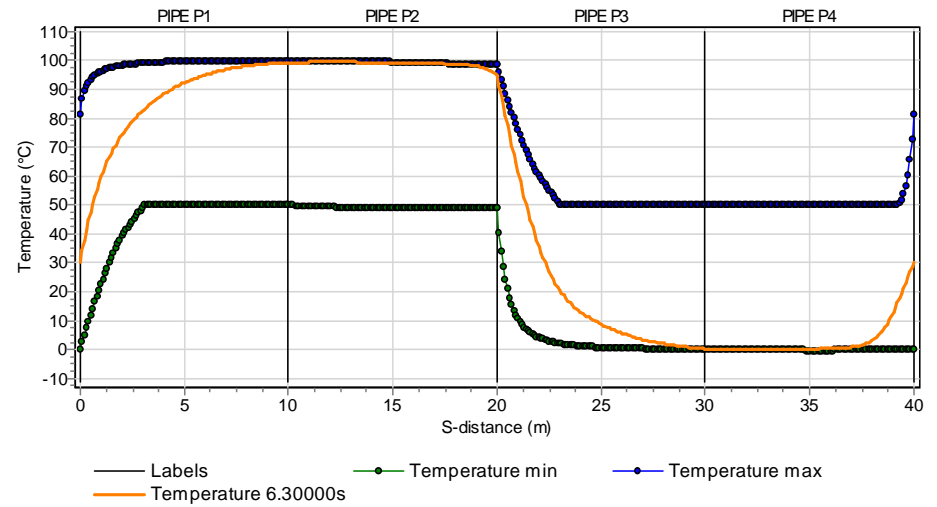
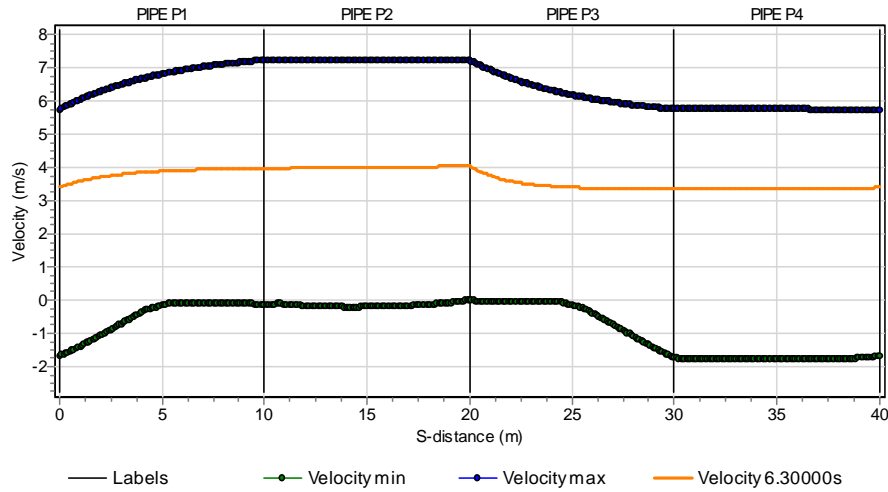
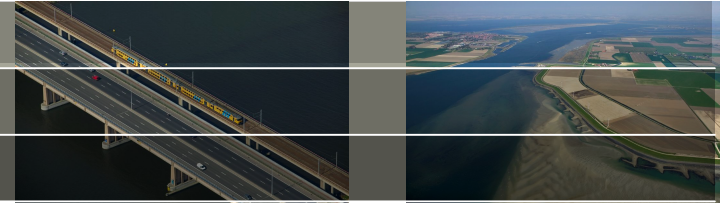

Convection after 6.3 s

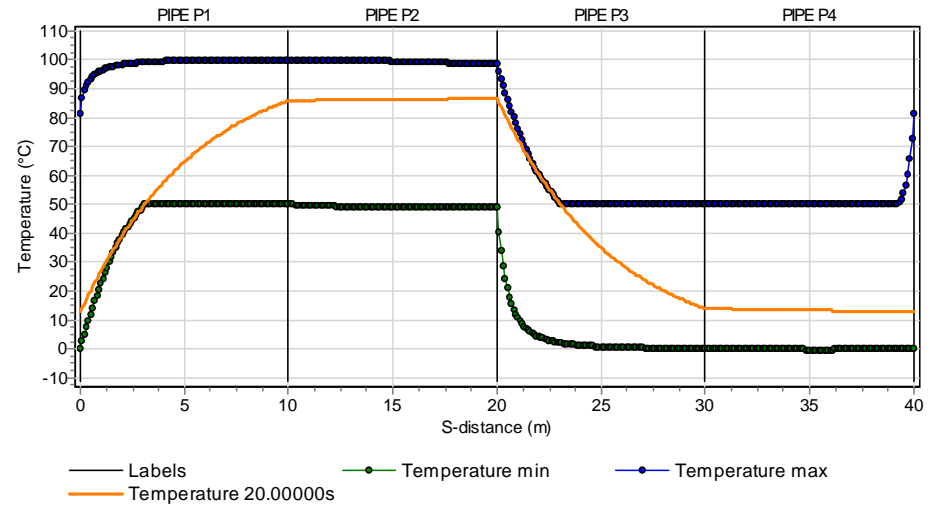
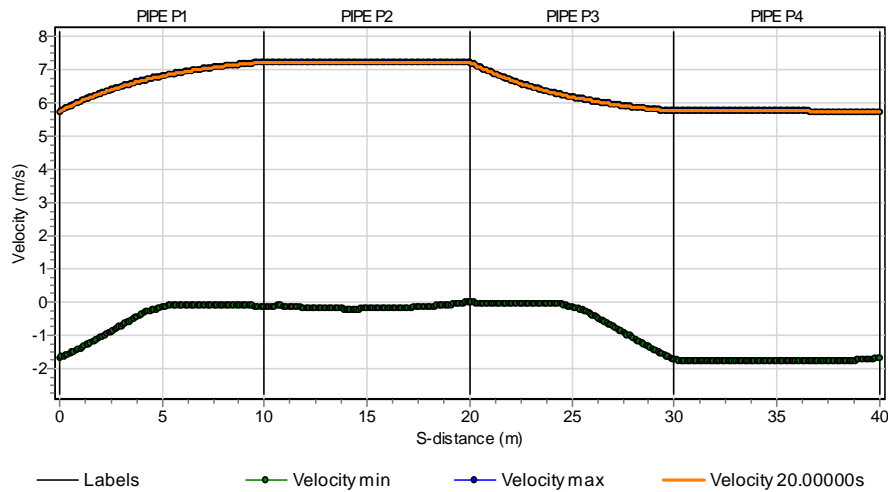

Convection after 20 s

Wanda 4 Gas

Example: HIPPS calculation

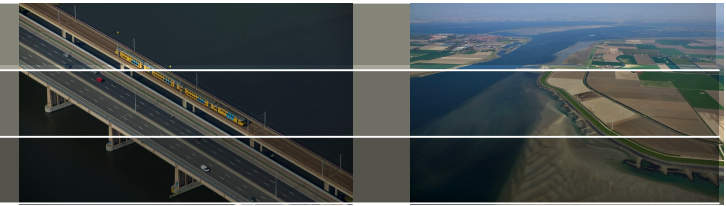

Oil well with Choke valve, pipeline network, and transportline
Choke valve breaks out
HIPPS valve closes in 2 seconds

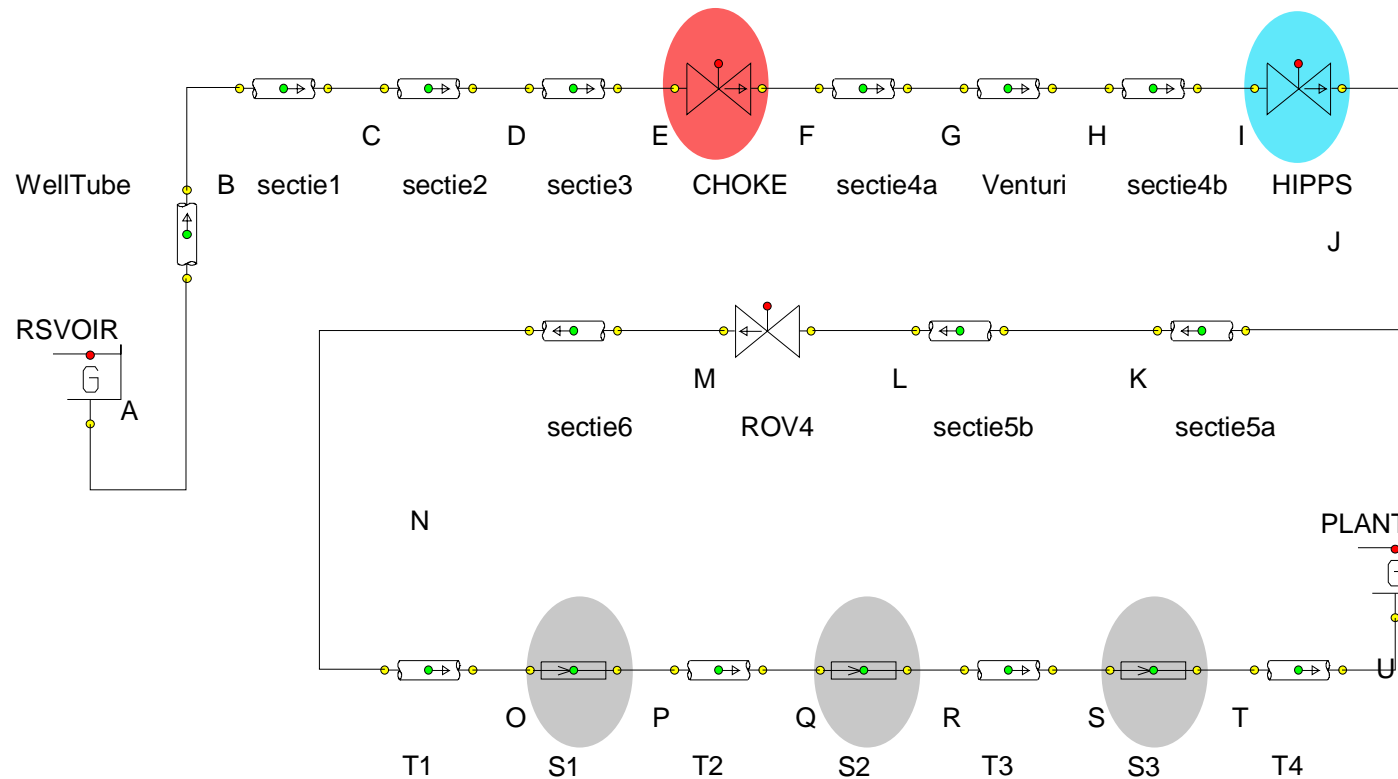

Wanda 4 Gas

Example: HIPPS calculation

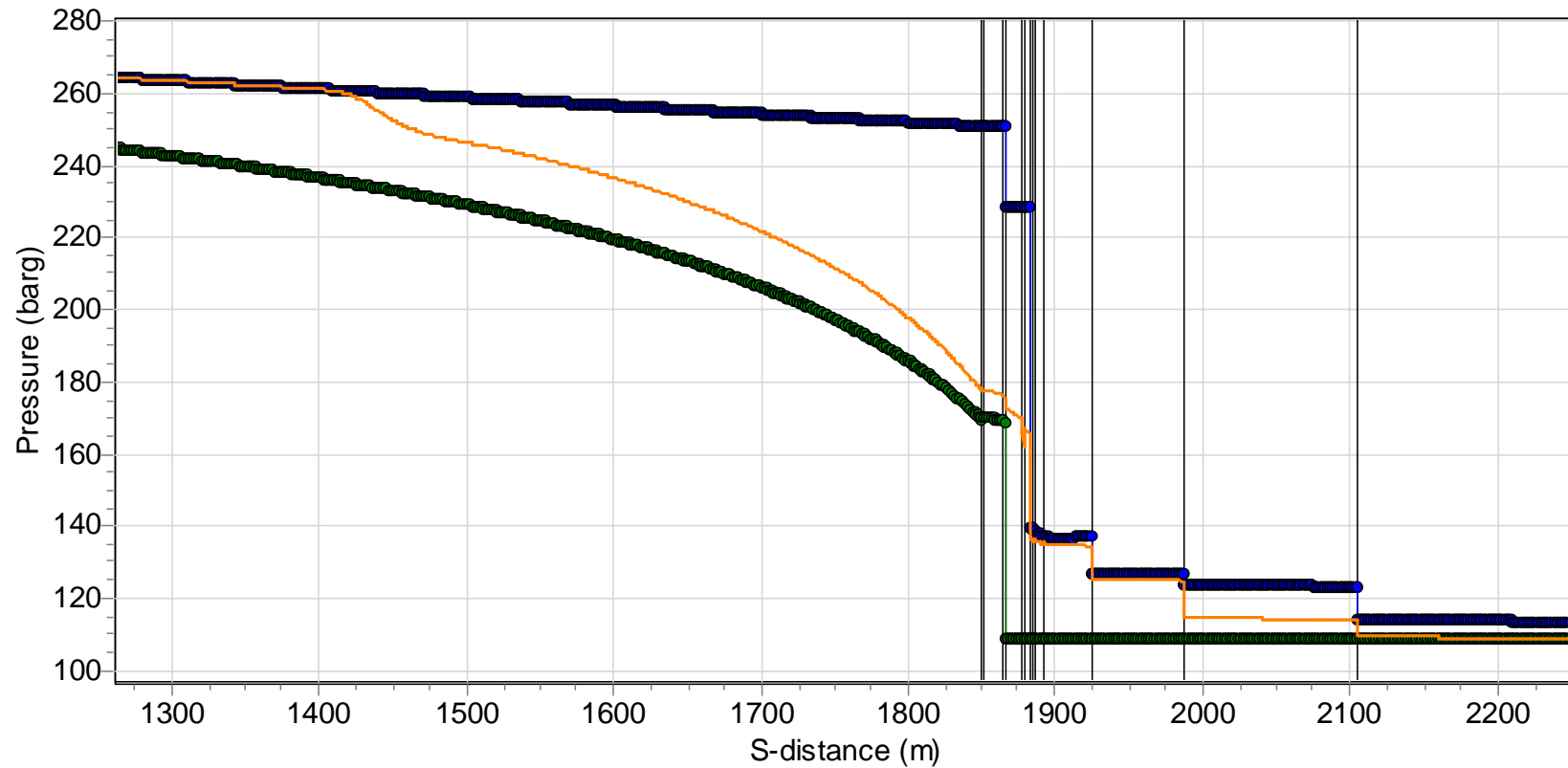
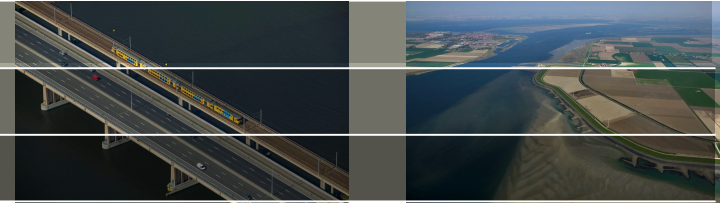

— Labels ● Pressure min ● Pressure max — Pressure 1.000s

Wanda 4 Gas

Example: HIPPS calculation

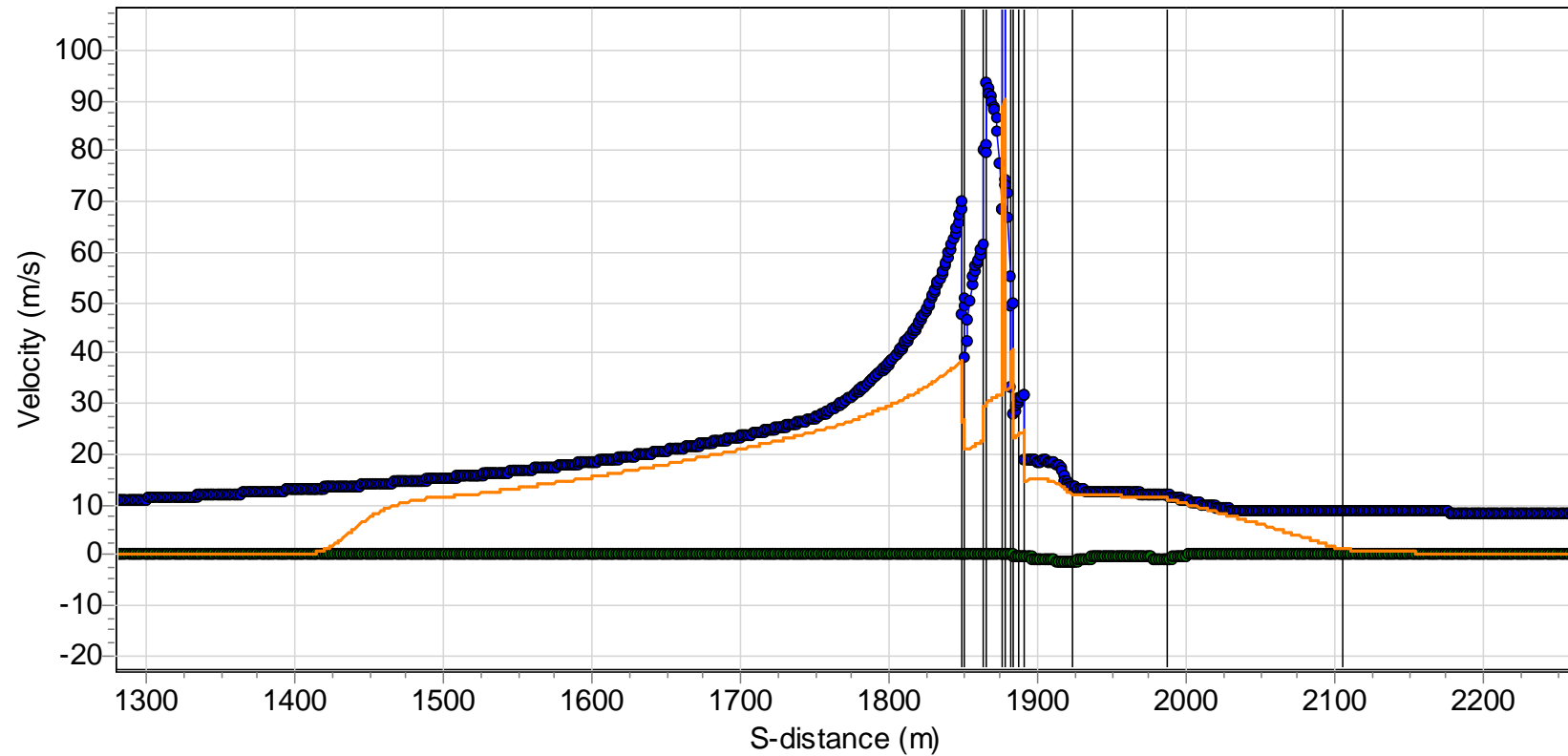
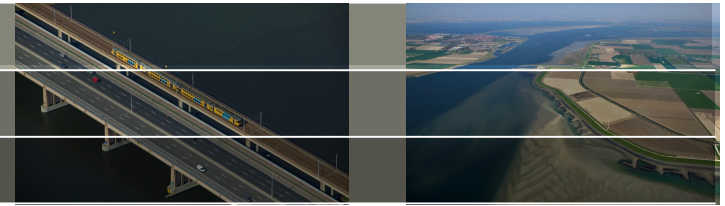

— Labels ● Velocity min ● Velocity max — Velocity 1.000s

Wanda 4 Gas

Example: HIPPS calculation

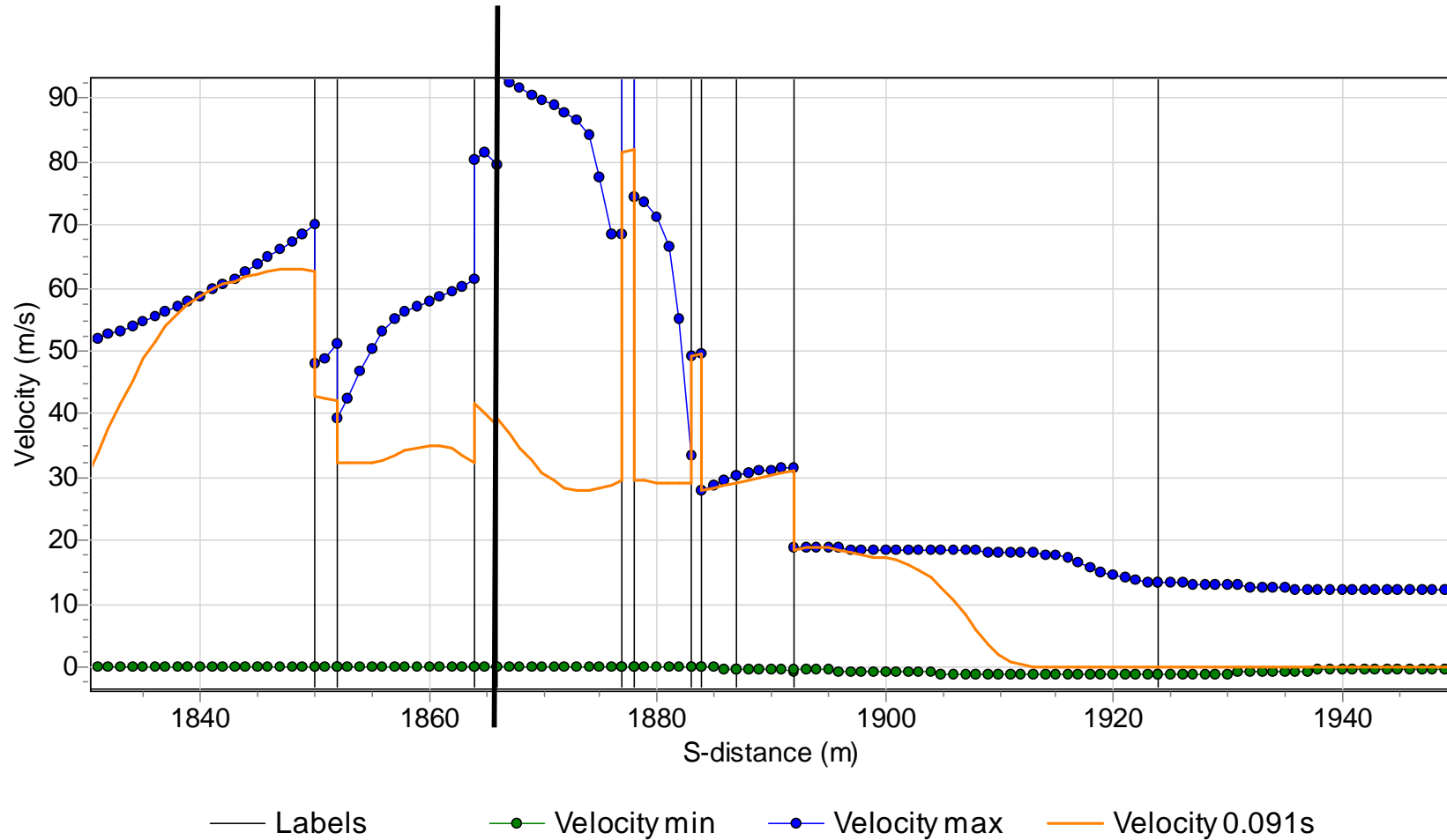
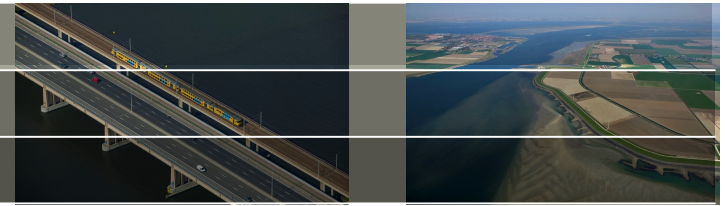

Wanda 4 Gas

Example: HIPPS calculation

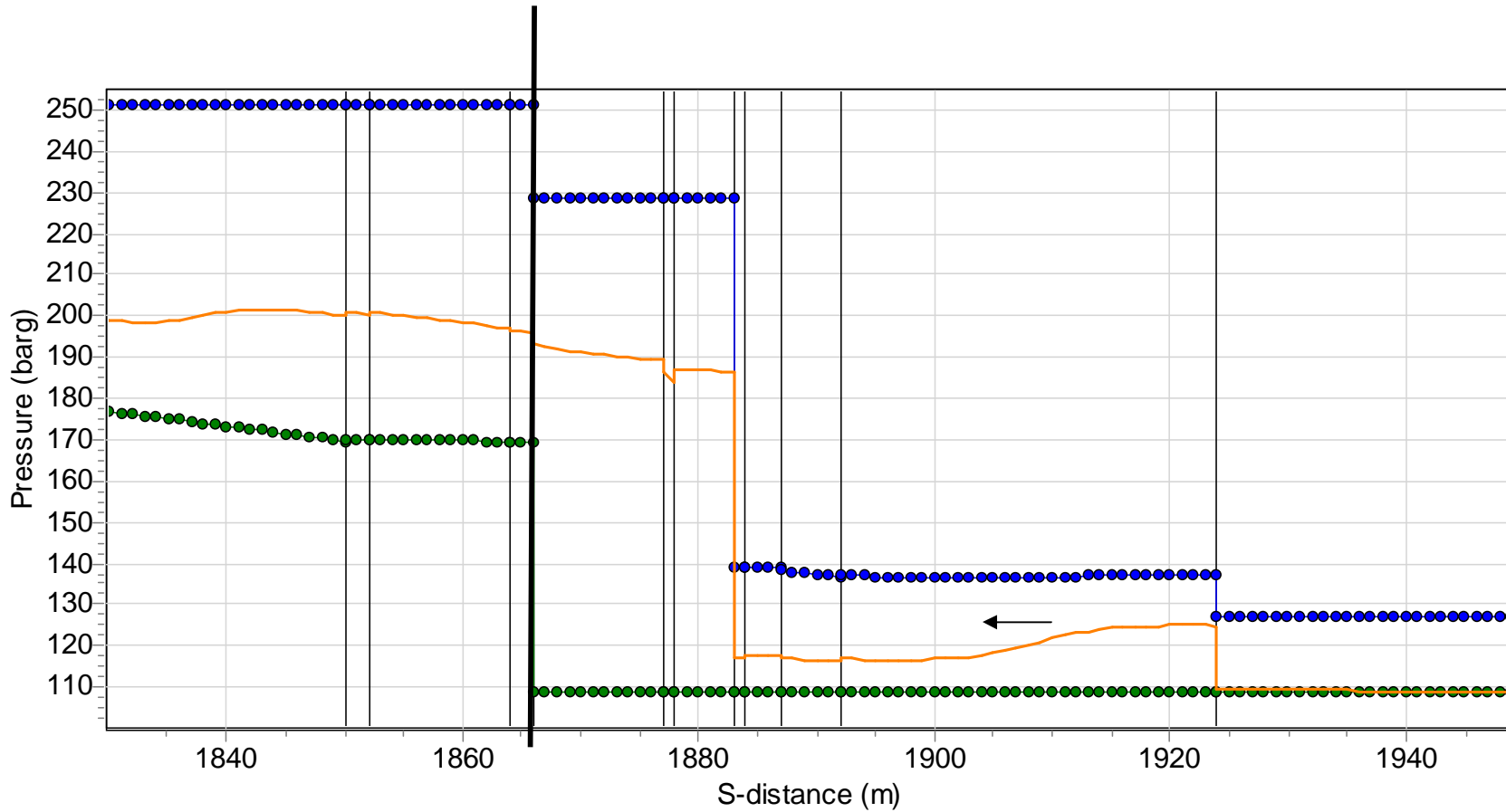
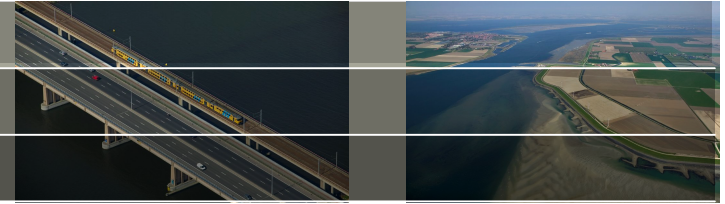

— Labels ● Pressure min ● Pressure max — Pressure 0.171s

Wanda 4 Gas

Example: HIPPS calculation

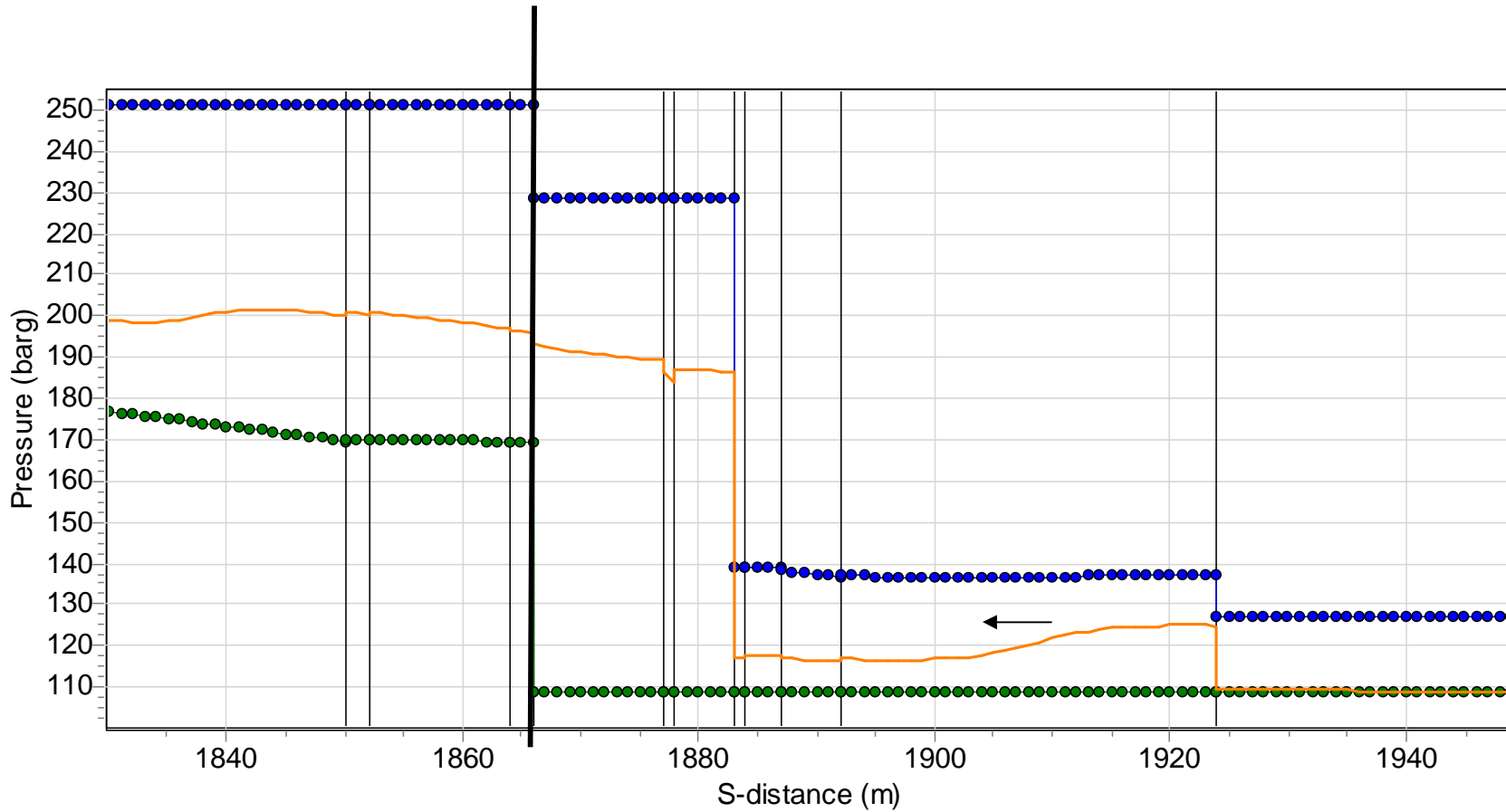
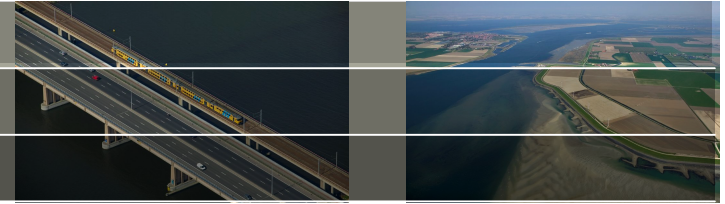

— Labels ● Pressure min ● Pressure max — Pressure 0.171s

Wanda 4 Gas

Example: HIPPS calculation

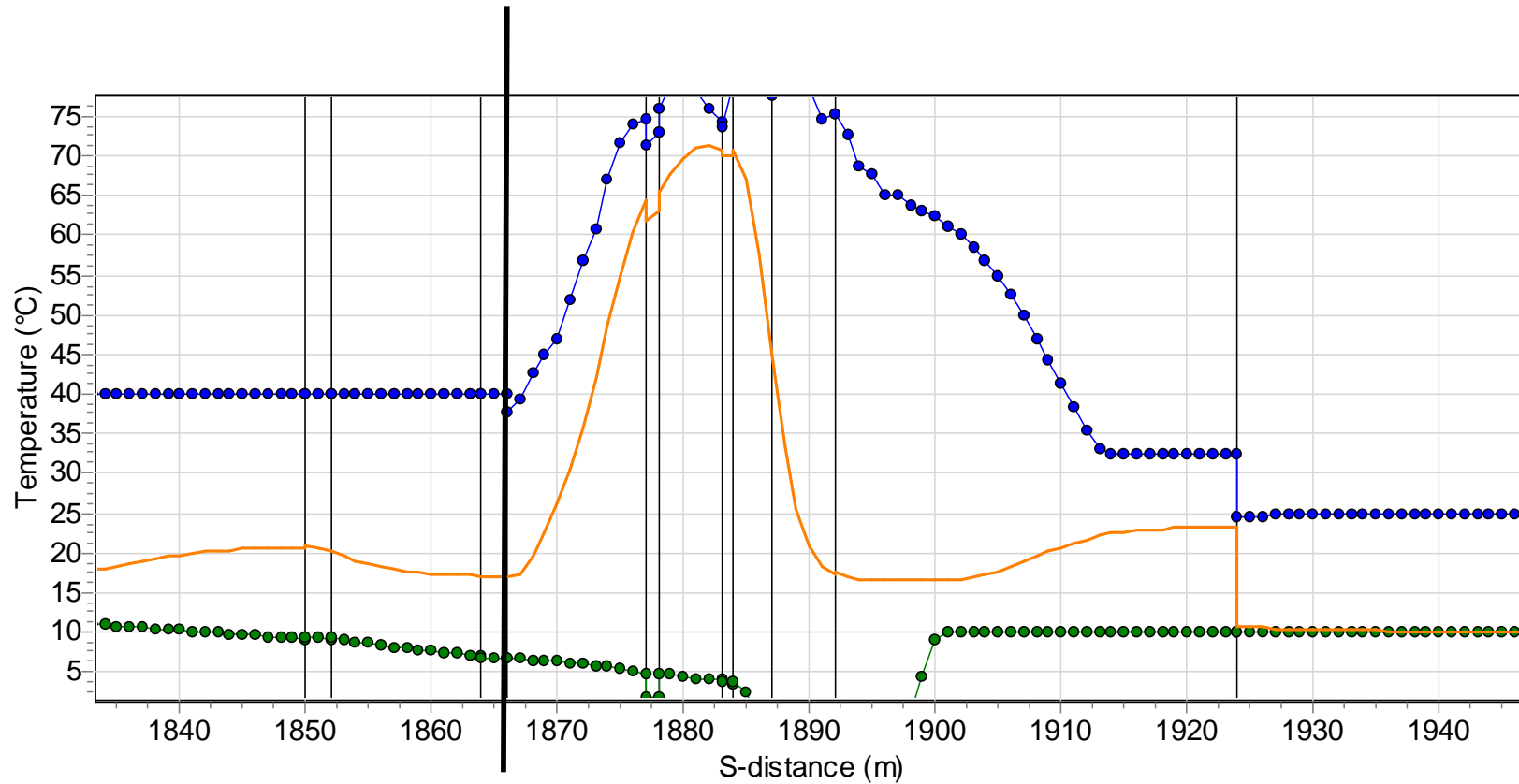
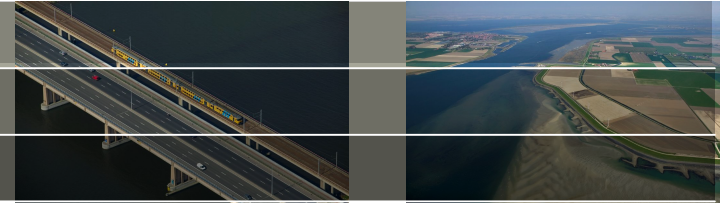

— Labels ● Temperature min ● Temperature max
— Temperature 0.171s